



**Overview**

**Abrasives**



**Automotive Tools**



**Hand Tools**



**Lubrication Equipment**



**Crimping & Cutting**

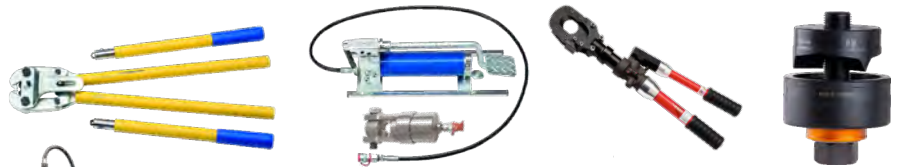

**Compressed Air Tools**

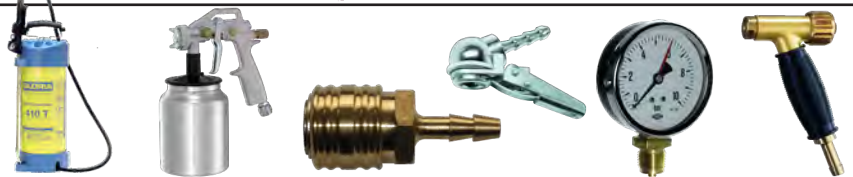

**Workshop**



**Measurement**



**Industrial Accessories**



**Industrial Safety**

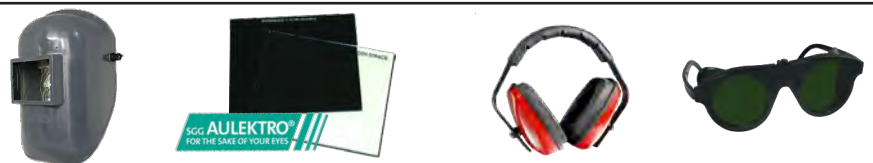

**Castor Wheels**





## Cutting & Grinding Discs - Stainless Steel



### TECHNOFLEX KISTENMACHER brand Cutting Discs for Stainless Steel INOX Type A60T / A46T-BF

the composition of the discs prevents the formation of rust, service life also good in normal steel with flat center

Art. No.	size (mm)	Ø (inch)	center
337222	100 x 1.0 x 16	4"	flat
299238	115 x 1.0 x 22.23	4.5"	flat
334235	115 x 1.6 x 22.23	4.5"	flat
337223	125 x 1.0 x 22.23	5"	flat

### TECHNOFLEX KISTENMACHER brand Cutting Discs for Stainless Steel INOX Type AS30 S

the composition of the discs prevents the formation of rust, service life also good in normal steel, with depressed center

Art. No.	size (mm)	Ø (inch)	center
	100 x 3.0 x 16	4"	depressed
329471	115 x 3.0 x 22.23	4.5"	depressed
337224	125 x 3.0 x 22.23	5"	depressed
	150 x 3.0 x 22.23	6"	depressed
	180 x 3.0 x 22.23	7"	depressed
	230 x 3.0 x 22.23	9"	depressed



### TECHNOFLEX KISTENMACHER brand Grinding Discs for Stainless Steel INOX Type A24 / 30Q-BF

good service and fast cutting all purpose disc - suitable for grinding all types of metal, sheet steel and welding seams, with depressed center

Art. No.	size (mm)	Ø (inch)	center
337226	100 x 6.5 x 16	4"	depressed
337227	115 x 6.5 x 22.23	4.5"	depressed
337228	125 x 6.5 x 22.23	5"	depressed
	150 x 6.5 x 22.23	6"	depressed
	180 x 6.5 x 22.23	7"	depressed
	230 x 6.5 x 22.23	9"	depressed



## Cutting Discs

### TECHNOFLEX KISTENMACHER brand Cutting Discs for Steel - Type A24 R-BF

good service and fast cutting all purpose disc,  
suitable for cutting all types of metal

with depressed center  
optionally with flat center

Art. No.	size (mm)	Ø (inch)	center
281370	100 x 3.0 x 16	4"	depressed
281371	115 x 3.0 x 22	4.5"	depressed
335480	125 x 3.0 x 22	5"	depressed
	150 x 3.0 x 22	6"	depressed
281372	180 x 3.0 x 22	7"	depressed
281373	230 x 3.0 x 22	9"	depressed



### TECHNOFLEX KISTENMACHER brand Cutting Discs for Stone - Type C24 R-BF

good service and fast cutting all purpose disc,  
suitable for cutting all types of stone, concrete, roof tiles etc.

with depressed center  
optionally with flat center

Art. No.	size (mm)	Ø (inch)	center
281792	100 x 3.0 x 16	4"	depressed
281793	115 x 3.0 x 22	4.5"	depressed
	125 x 3.0 x 22	5"	depressed
	150 x 3.0 x 22	6"	depressed
351034	180 x 3.0 x 22	7"	depressed
281794	230 x 3.0 x 22	9"	depressed



### TECHNOFLEX KISTENMACHER brand Cutting Discs for Steel - Type A30/36 - stationary use

good service and fast cutting all purpose disc,  
suitable for cutting all types of metal - flat center

Art. No.	size (mm)		finish
337417	300 x 2.8 x 25.4	AS 36 T	ST (T41)
337418	350 x 3.0 x 25.4	AS 36 T	ST (T41)
2301320	300 x 3.5 x 25.4	A 30 S	ST (T41)
2351320	350 x 3.5 x 25.4	A 30 S	ST (T41)
	400 x 3.2 x 25.4	A 36 S	ST (T41)
2400020	400 x 4.0 x 25.4	AS 30 S	ST (T41)





## Grinding Discs

### TECHNOFLEX KISTENMACHER brand Grinding Discs for Steel - Type A30T-BF T27

good service and fast cutting all purpose disc - suitable for grinding all types of metal, sheet steel and welding seams with depressed center

Art. No.	size (mm)	Ø (inch)	center
281376	100 x 6.5 x 16	4"	depressed
281377	115 x 6.5 x 22.23	4.5"	depressed
	125 x 6.5 x 22.23	5"	depressed
	150 x 6.5 x 22.23	6"	depressed
281378	180 x 6.5 x 22.23	7"	depressed
281381	230 x 6.5 x 22.23	9"	depressed

### TECHNOFLEX KISTENMACHER brand Grinding Discs for Stone - Type C30S-BF

good all purpose disc with durable service life for all types of stone, concrete, roof tiles etc. with depressed center

Art. No.	size (mm)	Ø (inch)	center
	100 x 6.5 x 16	4"	depressed
3116660	115 x 6.5 x 22.23	4.5"	depressed
3126660	125 x 6.5 x 22.23	5"	depressed
3156660	150 x 6.5 x 22.23	6"	depressed
3186660	180 x 6.5 x 22.23	7"	depressed
3236660	230 x 6.5 x 22.23	9"	depressed



### TECHNOFLEX KISTENMACHER brand Cup Grinding Wheels for Stone - C24 N-B

with thread M14  
size: 110 x 90 x 55 mm

Art. No. **346423** grit 24

**also available in grit 16 and 36**



### TECHNOFLEX KISTENMACHER brand Cup Grinding Wheels for Steel - A24 N-B

with thread M14  
size: 110 x 90 x 55 mm

Art. No. **346422** grit 24

**also available in grit 16 and 36**



## Flap Discs

### TECHNOFLEX KISTENMACHER brand Abrasive Flap Discs ECO Type 300 GT-S29

with fibreglass backing, suitable for steel, nonferrous and aluminium material



Art. No.	size (mm)	grit
370 115 EGK 40	115 x 22,2	40
370 115 EGK 60	115 x 22,2	60
370 115 EGK 80	115 x 22,2	80
370 115 EGK 120	115 x 22,2	120

Art. No.	size (mm)	grit
370 125 EGK 40	125 x 22,2	40
370 125 EGK 60	125 x 22,2	60
370 125 EGK 80	125 x 22,2	80
370 125 EGK 120	125 x 22,2	120



### TECHNOFLEX KISTENMACHER brand Abrasive Flap Discs PRO GT-S Type 303 VT 29

with fibreglass backing suitable for steel and stainless steel, with depressed center



Art. No.	size (mm)	grit
373 115 EGK 40	115 x 22,2	40
373 115 EGK 60	115 x 22,2	60
373 115 EGK 80	115 x 22,2	80
373 115 EGK 120	115 x 22,2	120

Art. No.	size (mm)	grit
373 125 EGK 40	125 x 22,2	40
373 125 EGK 60	125 x 22,2	60
373 125 EGK 80	125 x 22,2	80
373 125 EGK 120	125 x 22,2	120



## Abrasives



### VSM brand Vulcanfibre Discs - KF 708

for steel, shape S1 E

Art. No.	size (mm)	grain
727802	115 x 22	16
727803	115 x 22	24
727805	115 x 22	36
727806	115 x 22	40
727807	115 x 22	50
727808	115 x 22	60
727809	115 x 22	80
727810	115 x 22	100
727811	115 x 22	120

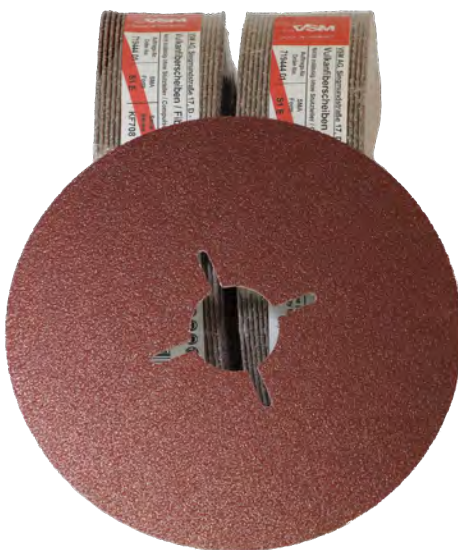

Art. No.	size (mm)	grain
727855	180 x 22	16
727856	180 x 22	24
727858	180 x 22	36
727859	180 x 22	40
727860	180 x 22	50
727861	180 x 22	60
727862	180 x 22	80
727863	180 x 22	100
727864	180 x 22	120

### VSM brand Vulcanfibre Discs - ZF 713

for stainless steel, shape S1 E

Art. No.	size (mm)	grain
728378	115 x 22	24
728379	115 x 22	36
728380	115 x 22	40
728381	115 x 22	50
728382	115 x 22	60
728383	115 x 22	80
728384	115 x 22	100
728385	115 x 22	120



Art. No.	size (mm)	grain
728414	180 x 22	24
728415	180 x 22	36
728416	180 x 22	40
728417	180 x 22	50
728418	180 x 22	60
728419	180 x 22	80
728420	180 x 22	100
728421	180 x 22	120

### VSM brand Vulcanfibre Discs - SF08

for stone, shape S1 E

Art. No.	size (mm)	grain
728313	115 x 22	24
728314	115 x 22	36
728316	115 x 22	60
728317	115 x 22	80
728319	115 x 22	120

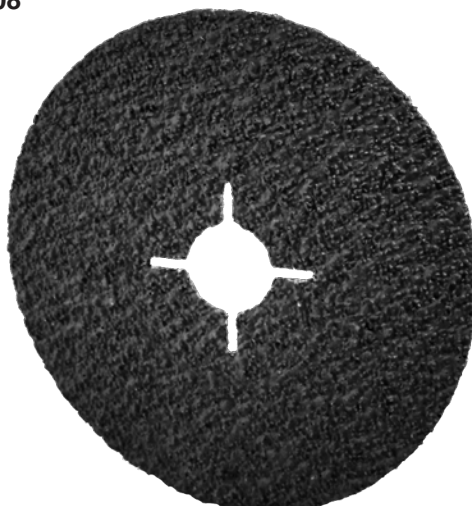

Art. No.	size (mm)	grain
728337	180 x 22	16
728338	180 x 22	24
728339	180 x 22	36
728341	180 x 22	60
728342	180 x 22	80
728343	180 x 22	120

## Abrasives

### VSM brand fibre disc - Type XF870

ceramic - for all kinds of steel, very good on stainless steels or superalloys.  
very long lifetime - aggressive cut -

Art. No.	size	grit	Art. No.	size	grit
737048	115 x 22 mm	24	737053	180 x 22 mm	24
731252	115 x 22 mm	36	731273	180 x 22 mm	36
731254	115 x 22 mm	40	731274	180 x 22 mm	40
731255	115 x 22 mm	50	731275	180 x 22 mm	50
731257	115 x 22 mm	60	731276	180 x 22 mm	60
731258	115 x 22 mm	80	731277	180 x 22 mm	80
737045	115 x 22 mm	100	737052	180 x 22 mm	100
731259	115 x 22 mm	120	731278	180 x 22 mm	120

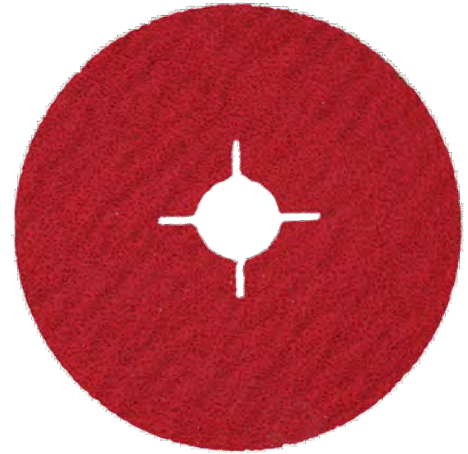

### VSM brand fibre disc - Type XF733

ceramic - for aluminium, unalloyed steel, non-ferrous metal, reduces the adhesion of the material to the abrasive grain. very long service life - self sharpening effect

Art. No.	size	grit	Art. No.	size	grit
787856	115 x 22 mm	24	787601	180 x 22mm	24
787587	115 x 22 mm	36	787602	180 x 22mm	36
787588	115 x 22 mm	60	787609	180 x 22mm	60
787591	115 x 22 mm	80	787611	180 x 22mm	80



### VSM brand fibre disc - Type KP131K

aluminium oxide - for wood and lacquer. On velour backed paper backing for self-sticking systems - lowrisk of clogging -

Art. No.	size	grit	Art. No.	size	grit
714302	150 x 18 mm	60	714317	150 x 18 mm	180
714303	150 x 18 mm	80	714318	150 x 18 mm	240
714304	150 x 18 mm	100	714287	150 x 18 mm	320
745952	150 x 18 mm	120	714321	150 x 18 mm	400
714313	150 x 18 mm	150			



### VSM brand Cut-roll Abrasive Cloth - Type KK114F

aluminium oxide - for universal use, very flexible cotton cloth - backing F-cotton

Art. No.	size	grit	Art. No.	size	grit
720569	100 mm x 50 mtr	40	720576	100 mm x 50 mtr	180
720571	100 mm x 50 mtr	60	720577	100 mm x 50 mtr	220
720572	100 mm x 50 mtr	80	720578	100 mm x 50 mtr	240
720573	100 mm x 50 mtr	100	720580	100 mm x 50 mtr	320
720574	100 mm x 50 mtr	120	720582	100 mm x 50 mtr	400
720575	100 mm x 50 mtr	150			



also available in width of 25, 30, 40, 50, 115, 120 mm

## Abrasives

### Backing pads with and without Velcro-Fastener

good scratch pattern due to damping and flexibility of backing pad, with M10/14 thread



Art. No.	size (inch)	description
6211205	4 1/2"	M14 with velcro
6212205	5	M14 with velcro
6218205	7	M14 with velcro
6211100	4 1/2"	M10 without velcro
6211105	4 1/2"	M14 without velcro
6212105	5	M14 without velcro
6218105	7	M14 without velcro



### KISTENMACHER brand Abrasive Flap Wheels

for metal, wood and plastic, with 6.0 mm shaft



Art. No.	D (mm)	B (mm)	S (mm)	P (grit)
100 40206 EGK 40	040	020	6	40
100 40206 EGK 60	040	020	6	60
100 40206 EGK 80	040	020	6	80
100 40206 EGK120	040	020	6	120
100 50206 EGK 40	050	020	6	40
100 50206 EGK 60	050	020	6	60
100 50206 EGK 80	050	020	6	80
100 50206 EGK120	050	020	6	120
100 50306 EGK 40	050	030	6	40
100 50306 EGK 60	050	030	6	60
100 50306 EGK 80	050	030	6	80
100 50306 EGK120	050	030	6	120
100 60306 EGK 40	060	030	6	40
100 60306 EGK 60	060	030	6	60
100 60306 EGK 80	060	030	6	80
100 60306 EGK120	060	030	6	120

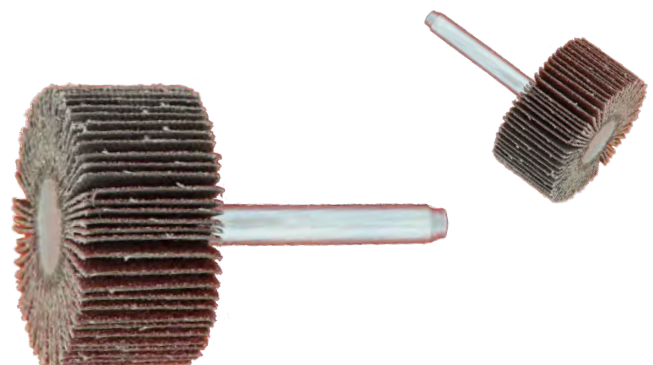
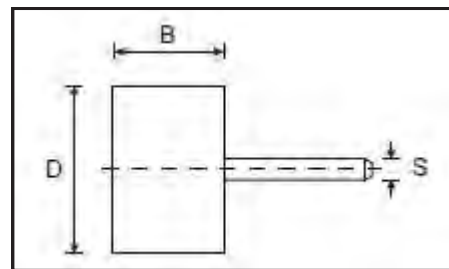

Other sizes and grits available upon request



# Abrasives



## TECHNOFLEX KISTENMACHER brand Unmounted Abrasive Flap Wheels Type 200

deburring, deflashing, cleaning, light grinding and mat finishing  
for stainless steel, light aluminium, wood and plastic  
available with bore 25,0 mm and 25,5 mm



Art. No.	plus grit	size (mm)	available grits
200 1002525 EGK	___	100 x 025 x 025	040-060-080-100-120-150-180-240-280-320
200 1003025 EGK	___	100 x 030 x 025	040-060-080-100-120-150-180-240-280-320
200 1202525 EGK	___	120 x 025 x 025	040-060-080-100-120-150-180-240-280-320
200 1203025 EGK	___	120 x 030 x 025	040-060-080-100-120-150-180-240-280-320
200 1303025 EGK	___	130 x 025 x 025	040-060-080-100-120-150-180-240-280-320
200 1303025 EGK	___	130 x 030 x 025	040-060-080-100-120-150-180-240-280-320
200 1402525 EGK	___	140 x 025 x 025	040-060-080-100-120-150-180-240-280-320
200 1403025 EGK	___	140 x 030 x 025	040-060-080-100-120-150-180-240-280-320
200 1405025 EGK	___	140 x 050 x 025	040-060-080-100-120-150-180-240-280-320

Art. No.	plus grit	size (mm)	size (inch)	recess	available grits
202 1502532 EGK	___	150 x 025 x 032	6 x 1 x 1"	2 x Ø 51x5	040-060-080-100-120-150-180-240-280-320
202 1503032 EGK	___	150 x 030 x 032		2 x Ø 51x7	040-060-080-100-120-150-180-240-280-320
202 1505032 EGK	___	150 x 050 x 032		2 x Ø 51x15	040-060-080-100-120-150-180-240-280-320
202 1652532 EGK	___	165 x 025 x 032		2 x Ø 51x5	040-060-080-100-120-150-180-240-280-320
202 1653032 EGK	___	165 x 030 x 032		2 x Ø 51x7	040-060-080-100-120-150-180-240-280-320
202 1655032 EGK	___	165 x 050 x 032		2 x Ø 51x15	040-060-080-100-120-150-180-240-280-320
202 2002551 EGK	___	200 x 025 x 051	8 x 1 x 2"	2 x Ø 76x5	040-060-080-100-120-150-180-240-280-320
202 2003051 EGK	___	200 x 030 x 051		2 x Ø 51x7	040-060-080-100-120-150-180-240-280-320
202 2005051 EGK	___	200 x 050 x 051		2 x Ø 76x15	040-060-080-100-120-150-180-240-280-320

## TECHNOFLEX KISTENMACHER brand Flanges for Recessed Abrasive Flap Wheels Type 202

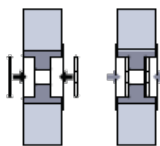
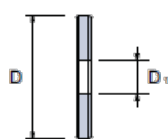

Art. No.	plus borehole size	size D x D (mm)	for wheel-diameter (mm)	available borehole sizes
202 051 000 EGK	___	51 x 10	150, 165	010-012-014-015-016-020-025
202 076 000 EGK	___	76 x 10	200	014-015-016-020-025-030-032

# Brushes

## Pipeline- / Joint-Brushes, knotted

optimal brushes for pipeline and piping construction  
 steel wire 0.50 mm  
 stainless steel wire 0.50 mm

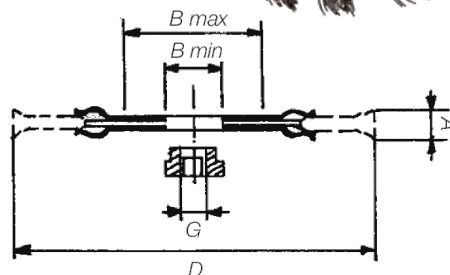

Art. No. steel wire	Art. No. stainless steel wire	D Ø (mm)	knots	bore (mm)	G thread	A (mm)	RPM (1/min)
110007350	110007250	100	24	22,2		6	12000
110017350	110017250	100	24		M14	6	12000
111507350	111507250	115	24	22,2		6	12000
111517350	111517250	115	24		M14	6	12000
112507350	112507250	125	40	22,2		6	12000
112517350	112517250	125	40		M14	6	12000
115007350	115007250	150	40	22,2		6	9000
115017350	115017250	150	40		M14	6	9000
117807350	117807250	178	64	22,2		6	9000
117817350	117817250	178	64		M14	6	9000

## Conical Brushes, knotted

efficient in corners and at edges  
 steel wire 0.50 mm  
 stainless steel wire 0.50 mm

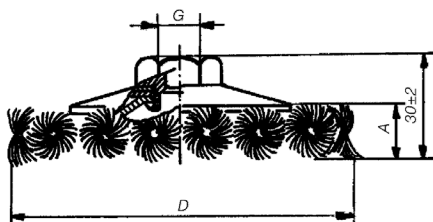

Art. No. steel wire	Art. No. stainless steel wire	D Ø (mm)	knots	G thread	A (mm)	RPM (1/min)
410014350	410014250	100	18	M14	13	12000
410012350		100	22	M14	13	12000
411514350	411514250	115	18	M14	13	12000
411512350	411512250	115	20	M14	13	12000
412513350	412513250	125	20	M14	13	10000
418513350		185	36	M14	13	4500
418503350		185	36	B22,2	13	4500

## Knotted Cup Brushes

high removal rate at high rotation  
 steel wire 0.50 mm  
 brass wire 0.50 mm  
 stainless steel wire 0.50 mm

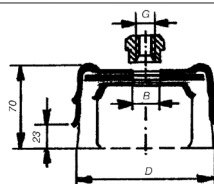

Art. No. steel wire	Art. No. brass wire	Art. No. stainless steel wire	D Ø (mm)	knots	bore (mm)	G thread	rows	RPM (1/min)
203513350			35*	16		M14	1	12000
204513350			45*	16		M14	1	12000
206516350	206516150		65	18		M14	1	12000
208004350	208004150	208004250	80	22	22,2		1	10500
208014350	208014150	208014250	80	22		M14	1	10500
210004350	210004150	210004250	100	30	22,2		1	8500
210014350	210014150	210014250	100	30		M14	1	8500
212004350	212004150	212004250	120	36	22,2		1	6500
212014350	212014150	212014250	120	36		M14	1	6500

# Brushes



## Surface Cleaning Brushes, crimped wire

effective on surfaces  
 steel wire 0.30 mm  
 brass wire 0.30 mm  
 stainless steel wire 0.30 mm



Art. No. steel	Art. No. brass	Art. No. stainless	D (Ø) mm	B bore / G thread	RPM (1/min)
606026330	606026130	606024230	60	16	12000
606016330	606016130	606014230	60	M14	12000
607526330	607526130	607524230	75	16	10000
607516330	607516130	607514230	75	M14	10000
608003330	608003130	608004230	80	22,2	10000
608013330	608013130	608014230	80	M14	10000
610003330	610003130	610004230	100	22,2	8500
610013330	610013130	610014230	100	M14	8500
612503330	612503130	612503230	125	22,2	6500
612513330	612513130	612513230	125	M14	6500
615003330	615003130	615003230	150	22,2	4500
615013335	615013130	615013230	150	M14	4500

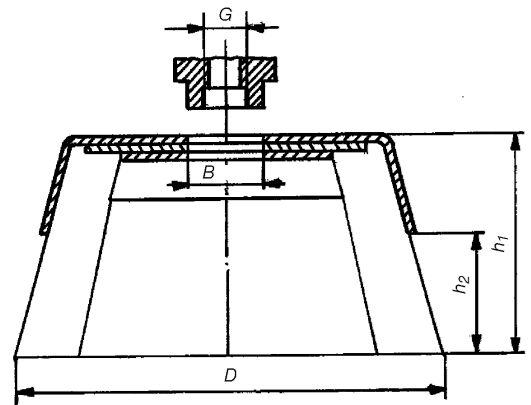

## 6 mm Shank Wheel Brushes, crimped wire

steel wire 0.30 mm  
 brass wire 0.20 mm  
 stainless steel wire 0.30 mm



## 6 mm Shank Cup Brushes, crimped wire

steel wire 0.30 / 0.35 mm  
 brass wire 0.20 / 0.25 mm  
 stainless steel wire 0.30 / 0.35 mm

Art. No. steel wire	Art. No. brass wire	Art. No. stainless steel wire	D (Ø) mm	A (mm)	RPM (1/min)
	802006120		20	6	20000
803008330	803008120	803008230	30	7 - 8	20000
804011330	804011120	804011230	40	10 - 12	18000
805008330			50	8 - 10	4500
805011330	805011120	805011230	50	10 - 12	15000
805017330	805017120	805017230	50	16 - 18	15000
806012330	806012120	806012230	60	10 - 12	15000
806018330	806018120	806018230	60	16 - 18	15000
807012330	807012120	807012230	70	10 - 12	15000
807018330	807018120	807018230	70	17 - 19	15000
807510330	807510120	807510230	75	8 - 10	4500
808012330	808012120	808012230	80	12 - 14	15000
808019330	808019120	808019230	80	18 - 20	15000
810010335	810010130	810010230	100	8 - 10	10000

Art. No. steel wire	Art. No. brass wire	Art. No. stainless steel wire	D (Ø) mm	RPM (1/min)
605071330	605071120	605071230	50	4500
605071335	605171125	605071235	50	4500
607071330	607071120	605071230	70	4500
607571335	607571125	605071235	75	4500

## 6 mm shank Wheel and Cup Brushes, knotted

steel wire 0.50 mm  
 stainless steel wire 0.50 mm



Art. No. steel wire	Art. No. stainless steel wire	D (Ø) mm	knots	rows	RPM (1/min)
107571350	107571250	75	16	1	20000
109071350	109071250	90	16	1	20000
107081350	107081250	70	16	2	20000
305571350	305571250	55	16	1	6000



## Brushes

### Tube Brushes with external M12 / 1/2" thread available in

steel wire 0.35 mm straight  
 steel wire 0.30 mm crimped  
 brass wire 0.30 mm crimped



Art. No. straight steel wire	Art. No. crimped steel wire	Art. No. crimped brass wire	mm (Ø)
090203	09020330	09020130	20
090223	09022330	09022130	22
090253	09025330	09025130	25
090303	09030330	09030130	30
090323	09032330	09032130	32
090383	09038330	09038130	38
090443	09044330	09044130	44
090503	09050330	09050130	50
090573	09057330	09057130	57
090633	09063330	09063130	63
090693	09069330	09069130	69
090753	09075330	09075130	75
090823	09082330	09082130	82
090943	09094330	09094130	94
091013	09101330	09101130	101

### Hand Wire Brushes

suitable for derusting, removal of paint residues and cleaning, 4-rows, in cartons of 12 pcs.

also available in 3-rows and 5-rows



straight steel wire: 001.143523

crimped brass wire: 002.243523

straight stainless steel wire (INOX): 001.1431230



### Spark Plug Brushes

for automotive workshops and fine machining, 3-rows

Art. No.: 13115  
 Art. No.: 13120  
 Art. No.: 13125

crimped brass wire 0.15 mm  
 crimped brass wire 0.20 mm  
 crimped brass wire 0.25 mm



### File Cards

for cleaning wood and metal files, file length 100 mm

Art. No.: 280225  
 Art. No.: 280240  
 Art. No.: 280250

200 x 25 mm  
 200 x 40 mm  
 200 x 50 mm



### Street Brooms

wooden body, with straight red PVC bristles



Art. No.	size (cm)	rows
10316	29	5
10916	40	6
12516	50	6
13016	60	6

### Floor Brooms

wooden body, with straight black PVC bristles



Art. No.	size (cm)
23010	30
24010	40
25010	50
26010	60

### Floor Squeegees

with metal support



Art. No.	size (cm)
36235	35
36245	45
36260	60



# Combination Spanners



**WIESEMANN** 1893  
GERMANY

## Combination Spanners - Type 300

chrome vanadium steel, chrome plated  
ring 15° offset, DIN 3113 B

Art. No.	size (mm)
300c0707	7
300c0808	8
300c0909	9
300c1010	10
300c1111	11
300c1212	12
300c1313	13
300c1414	14
300c1515	15

Art. No.	size (mm)
300c1616	16
300c1717	17
300c1919	19
300c2222	22
300c2323	23
300c4646	46
300c5050	50
300c5555	55



## Combination Spanners - Type 350 - Short Pattern

chrome vanadium steel, chrome plated  
ring 15° offset, DIN 3113 A

Art. No.	size (mm)
350c0606	6
350c0707	7
350c0808	8
350c0909	9
350c1010	10
350c1111	11
350c1212	12
350c1313	13
350c1414	14
350c1515	15
350c1616	16
350c1717	17

Art. No.	size (mm)
350c1818	18
350c1919	19
350c2020	20
350c2121	21
350c2222	22
350c2323	23
350c2424	24
350c2727	27
350c3030	30
350c3232	32
350c3434	34
350c3636	36

Art. No.	size (inch)
3500001c	1/4
3500002c	5/16
3500003c	3/8
3500004c	7/16
3500005c	1/2
3500006c	9/16

Art. No.	size (inch)
3500007c	19/32
3500008c	5/8
3500009c	11/16
3500010c	3/4
3500012c	13/16
3500013c	7/8

Art. No.	size (inch)
3500014c	15/16
3500015c	1
3500016c	1.1/16
3500017c	1.1/8
3500019c	1.1/4

## Double Ended Ring Spanners



**WIESEMANN** 1893  
GERMANY

### Double Ended Ring Spanners - Type 100

chrome vanadium steel, chrome plated  
deep offset

Art. No.	size (mm)
100c0607	6 x 7
100c0708	7 x 8
100c0809	8 x 9
100c0810	8 x 10
100c0911	9 x 11
100c1011	10 x 11
100c1012	10 x 12
100c1013	10 x 13
100c1113	11 x 13
100c1213	12 x 13
100c1214	12 x 14
100c1314	13 x 14
100c1315	13 x 15

Art. No.	size (mm)
100c1317	13 x 17
100c1415	14 x 15
100c1417	14 x 17
100c1617	16 x 17
100c1618	16 x 18
100c1719	17 x 19
100c1722	17 x 22
100c1819	18 x 19
100c1922	19 x 22
100c1924	19 x 24
100c2022	20 x 22
100c2123	21 x 23
100c2224	22 x 24

Art. No.	size (mm)
100c2426	24 x 26
100c2427	24 x 27
100c2430	24 x 30
100c2528	25 x 28
100c2730	27 x 30
100c2732	27 x 32
100c3032	30 x 32
100c3036	30 x 36
100c3236	32 x 36
100c3436	34 x 36
100c3641	36 x 41
100c4146	41 x 46
100c4650	46 x 50

Art. No.	size (inch)
1000001c	1/4 x 5/16
1000002c	5/16 x 3/8
1000003c	3/8 x 7/16
1000004c	7/16 x 1/2
1000005c	1/2 x 9/16

Art. No.	size (inch)
1000006c	9/16 x 5/8
1000007c	19/32 x 11/16
1000008c	5/8 x 11/16
1000009c	5/8 x 3/4

Art. No.	size (inch)
1000010c	3/4 x 7/8
1000011c	13/16 x 7/8
1000012c	15/16 x 1
1000014c	1.1/16x 1.1/4



### Double Ended Ring Spanners - Type 150 - Short Pattern

chrome vanadium steel, chrome plated  
deep offset

Art. No.	size (mm)
150c0607	6 x 7
150c0809	8 x 9
150c1011	10 x 11
150c1213	12 x 13

Art. No.	size (mm)
150c1415	14 x 15
150c1617	16 x 17
150c1819	18 x 19
150c2022	20 x 22

Art. No.	size (mm)
150c2123	21 x 23
150c2426	24 x 26
150c2528	25 x 28
150c2732	27 x 32



## Double Ended Open Spanners



### Double Ended Open Jaw Spanners - Type 200

chrome vanadium steel, chrome plated

**WIESEMANN** 1893  
GERMANY

Art. No.	size (mm)
200c55007	5,5 x 7
200c0607	6 x 7
200c0708	7 x 8
200c0709	7 x 9
200c0809	8 x 9
200c0810	8 x 10
200c0910	9 x 10
200c0911	9 x 11
200c1011	10 x 11
200c1012	10 x 12
200c1013	10 x 13
200c1113	11 x 13
200c1114	11 x 14
200c1213	12 x 13

Art. No.	size (mm)
200c1214	12 x 14
200c1314	13 x 14
200c1315	13 x 15
200c1317	13 x 17
200c1415	14 x 15
200c1417	14 x 17
200c1617	16 x 17
200c1618	16 x 18
200c1719	17 x 19
200c1722	17 x 22
200c1819	18 x 19
200c1922	19 x 22
200c1924	19 x 24
200c2022	20 x 22

Art. No.	size (mm)
200c2123	21 x 23
200c2224	22 x 24
200c2426	24 x 26
200c2427	24 x 27
200c2528	25 x 28
200c2730	27 x 30
200c2732	27 x 32
200c3032	30 x 32
200c3036	30 x 36
200c3236	32 x 36
200c3436	34 x 36
200c3641	36 x 41
200c4146	41 x 46
200c4650	46 x 50

Art. No.	size (inch)
2000001c	1/4 x 5/16
2000002c	5/16 x 3/8
2000003c	3/8 x 7/16
2000004c	7/16 x 1/2
2000005c	1/2 x 9/16

Art. No.	size (inch)
2000007c	9/16 x 5/8
2000008c	19/32 x 11/16
2000009c	5/8 x 11/16
2000010c	5/8 x 3/4

Art. No.	size (inch)
2000012c	3/4 x 7/8
2000013c	13/16 x 7/8
2000014c	15/16 x 1
2000016c	1.1/16x 1.1/4

### Double Ended Open Jaw Spanners - Type 250 - Short Pattern

chrome vanadium steel, chrome plated

Art. No.	size (mm)
250c0607	6 x 7
250c0809	8 x 9
250c1011	10 x 11
250c1213	12 x 13

Art. No.	size (mm)
250c1415	14 x 15
250c1617	16 x 17
250c1819	18 x 19
250c2022	20 x 22

Art. No.	size (mm)
250c2123	21 x 23
250c2426	24 x 26
250c2528	25 x 28
250c2732	27 x 32



## Spanner Sets

### Combination Spanner Sets

chrome vanadium steel, chrome plated

in carton box

**WIESEMANN** 1893  
GERMANY

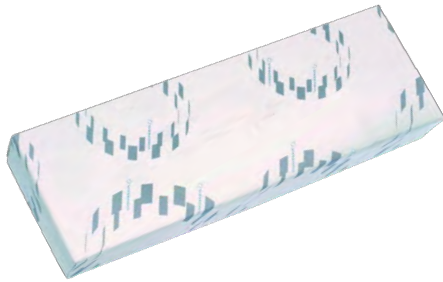

Art. No.	pcs per set	sizes
350 K6/c/S	6	8, 10, 11, 13, 17, 19
350 K8/c	8	8, 10, 11, 13, 14, 17, 19, 22
350 K12/c/6-32	12	6, 7, 8, 10, 12, 13, 14, 17, 19, 22, 27, 32
350k 6ac	6	3/8, 7/16, 1/2, 9/16, 5/8, 3/4
350k 8ac	8	1/4, 5/16, 3/8, 7/16, 1/2, 9/16, 5/8, 3/4
350k 12ac	12	1/4, 5/16, 3/8, 7/16, 1/2, 9/16, 5/8, 3/4, 7/8, 1.1/16, 1.1/4



### Combination Spanner Sets

chrome vanadium steel, chrome plated

in plastic wallet

Art. No.	pcs per set	sizes
350 T8/c	8	8, 9, 10, 11, 13, 14, 17, 19
350 T8/c/S	8	8, 10, 11, 13, 14, 17, 19, 22
350 T12/c/6-22	12	6, 7, 8, 9, 10, 11, 12, 13, 14, 17, 19, 22
350 T12/c/6-32	12	6, 8, 10, 13, 14, 17, 19, 22, 24, 27, 30, 32
350 T12/c/S6-32/S	12	6, 8, 10, 12, 13, 14, 17, 19, 22, 24, 27, 32
350 T12/cfAH	12	6, 7, 8, 10, 12, 13, 14, 17, 19, 22, 27, 32



### Double Ended Ring Spanner Sets

chrome vanadium steel, chrome plated

Type 100 - deep offset

Type 150 - short pattern offset

in carton box

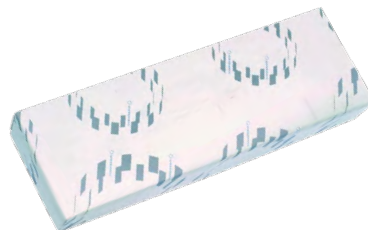

Art. No.	pcs per set	sizes
100 K8/c	8	6 x 7, 8 x 9, 10 x 11, 12 x 13, 14 x 15, 16 x 17, 18 x 19, 20 x 22
100 K12/c	12	6 x 7, 8 x 9, 10 x 11, 12 x 13, 14 x 15, 16 x 17, 18 x 19, 20 x 22, 21 x 23, 24 x 26, 25 x 28, 27 x 32
100K 6ac	6	3/8 x 7/16, 1/2 x 9/16, 19/32 x 11/16, 5/8 x 3/4, 13/16 x 7/8, 15/16 x 1
100K 8ac	8	1/4 x 5/16, 3/8 x 7/16, 1/2 x 9/16, 19/32 x 11/16, 5/8 x 3/4, 13/16 x 7/8, 15/16 x 1, 1.1/16 x 1.1/4
150 K6/c	6	6 x 7, 8 x 9, 10 x 11, 12 x 13, 14 x 15, 16 x 17
150 K8/c	8	6 x 7, 8 x 9, 10 x 11, 12 x 13, 14 x 15, 16 x 17, 18 x 19, 20 x 22
150 K12/c	12	6 x 7, 8 x 9, 10 x 11, 12 x 13, 14 x 15, 16 x 17, 18 x 19, 20 x 22, 21 x 23, 24 x 26, 25 x 28, 27 x 32



## Spanner Sets



### Double Ended Ring Spanner Sets

chrome vanadium steel, chrome plated

Type 100 - deep offset

Type 150 - short pattern offset

in plastic wallet

**WIESEMANN** 1893  
GERMANY

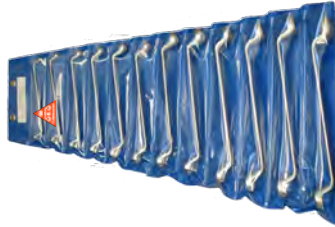

Art. No.	pcs per set	sizes
100 T 8/c	8	6 x 7, 8 x 9, 10 x 11, 12 x 13, 14 x 15, 16 x 17, 18 x 19, 20 x 22
100 T12/c	12	6 x 7, 8 x 9, 10 x 11, 12 x 13, 14 x 15, 16 x 17, 18 x 19, 20 x 22, 21 x 23, 24 x 26, 25 x 28, 27 x 32
150 T 6/c	6	6 x 7, 8 x 9, 10 x 11, 12 x 13, 14 x 15, 16 x 17
150 T 8/c	8	6 x 7, 8 x 9, 10 x 11, 12 x 13, 14 x 15, 16 x 17, 18 x 19, 20 x 22
150 T12/c	12	6 x 7, 8 x 9, 10 x 11, 12 x 13, 14 x 15, 16 x 17, 18 x 19, 20 x 22, 21 x 23, 24 x 26, 25 x 28, 27 x 32

### Double Ended Open Jaw Spanner Sets

Type 200

Type 250 - short pattern

in carton box

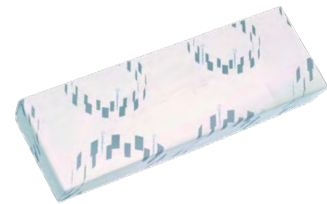
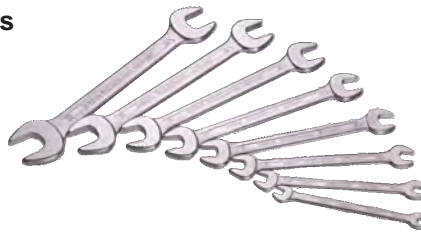

Art. No.	pcs per set	sizes
200 K 8/c	8	6 x 7, 8 x 9, 10 x 11, 12 x 13, 14 x 15, 16 x 17, 18 x 19, 20 x 22
200 K 12/c	12	6 x 7, 8 x 9, 10 x 11, 12 x 13, 14 x 15, 16 x 17, 18 x 19, 20 x 22, 21 x 23, 24 x 26, 25 x 28, 27 x 32
200K 6ac	6	3/8 x 7/16, 1/2 x 9/16, 19/32 x 11/16, 5/8 x 3/4, 13/16 x 7/8, 15/16 x 1
200K 8ac	8	1/4 x 5/16, 3/8 x 7/16, 1/2 x 9/16, 19/32 x 11/16, 5/8 x 3/4, 13/16 x 7/8, 15/16 x 1, 1.1/16 x 1.1/4
250 K 6/c	6	6 x 7, 8 x 9, 10 x 11, 12 x 13, 14 x 15, 16 x 17
250 K 8/c	8	6 x 7, 8 x 9, 10 x 11, 12 x 13, 14 x 15, 16 x 17, 18 x 19, 20 x 22
250 K 12/c	12	6 x 7, 8 x 9, 10 x 11, 12 x 13, 14 x 15, 16 x 17, 18 x 19, 20 x 22, 21 x 23, 24 x 26, 25 x 28, 27 x 32

### Double Ended Open Jaw Spanner Sets

Type 200

Type 250 - short pattern

in plastic wallet



Art. No.	pcs per set	sizes
200 T 8/c	8	6 x 7, 8 x 9, 10 x 11, 12 x 13, 14 x 15, 16 x 17, 18 x 19, 20 x 22
200 T12/c	12	6 x 7, 8 x 9, 10 x 11, 12 x 13, 14 x 15, 16 x 17, 18 x 19, 20 x 22, 21 x 23, 24 x 26, 25 x 28, 27 x 32
250 T 6/c	6	6 x 7, 8 x 9, 10 x 11, 12 x 13, 14 x 15, 16 x 17
250 T 8/c	8	6 x 7, 8 x 9, 10 x 11, 12 x 13, 14 x 15, 16 x 17, 18 x 19, 20 x 22
250 T 12/c	12	6 x 7, 8 x 9, 10 x 11, 12 x 13, 14 x 15, 16 x 17, 18 x 19, 20 x 22, 21 x 23, 24 x 26, 25 x 28, 27 x 32

## Slogging Wrenches

### Slogging Ring Wrenches

special drop forged steel

**WIESEMANN** 1893  
GERMANY



Art. No.	size (mm)	Art. No.	size (mm)	Art. No.	size (mm)
600sg24	24	600sg70	70	600sg70	130
600sg27	27	600sg75	75	600sg75	135
600sg30	30	600sg80	80	600sg80	140
600sg32	32	600sg85	85	600sg85	145
600sg36	36	600sg90	90	600sg90	150
600sg38	38	600sg95	95	600sg95	155
600sg41	41	600sg100	100	600sg100	160
600sg46	46	600sg105	105	600sg105	165
600sg50	50	600sg110	110	600sg110	170
600sg55	55	600sg115	115	600sg115	175
600sg60	60	600sg120	120	600sg120	180
600sg65	65	600sg125	125		

### Slogging open Jaw Wrenches

special drop forged steel



Art. No.	size (mm)	Art. No.	size (mm)	Art. No.	size (mm)
610sg24	24	610sg70	70	610sg125	125
610sg27	27	610sg75	75	610sg130	130
610sg30	30	610sg80	80	610sg135	135
610sg32	32	610sg85	85	610sg140	140
610sg36	36	610sg90	90	610sg145	145
610sg41	41	610sg95	95	610sg150	150
610sg46	46	610sg100	100	610sg155	155
610sg50	50	610sg105	105	610sg160	160
610sg55	55	610sg110	110	610sg165	165
610sg60	60	610sg115	115	610sg170	170
610sg65	65	610sg120	120	610sg175	175
				610sg180	180

## Socket Sets and Ratchets

### WGB brand Socket Sets 1/2" drive

sockets made of Chrome-Vanadium steel  
chromium-plated, in sheet steel box  
24 pcs per set, consisting of:

sockets: 10, 11, 12, 13, 14, 15, 16, 17, 18, 19, 20,  
21, 22, 23, 24, 27, 30, 32 mm

accessories:

- 352 (Universal Joint 73 mm)
- 356 (Extension 125 mm)
- 356 (Extension 250 mm)
- 354 (T-slide Handle 300 mm)
- 353 (Speeder)
- 3066 (Reversible Ratchet 255 mm - 72 teeth)



Further socket sets available on request e.g. 1/4", 3/8" drive

### Reversible Ratchet

lever type, 72 teeth  
made of Chrome-Vanadium steel  
two component handle



Art. No.	square	teeth	length
5012003	1/4"	72	140
2356003	3/8"	72	190
3066003	1/2"	72	250

### Reversible Ratchet

lever type, 43,41,45 teeth  
made of Chrome-Vanadium steel  
two component handle



Art. No.	square drive	teeth	length (mm)
9291683	1/4"	43	140
9291693	3/8"	41	200
9291703	1/2"	45	250

## Ratchets

### Extension Bar

Chrome-Vanadium steel,  
chrome plated



Art. No.	square drive	length (mm)
9208783	1/4"	55
9228713	1/4"	75
9208793	1/4"	105
9226143	1/4"	150
9224033	3/8"	50
9225923	3/8"	75
9224053	3/8"	125
9224043	3/8"	150
9224063	3/8"	250
9215133	3/4"	200
9215143	3/4"	400
9224693	1/2"	75
9200103	1/2"	125
9200113	1/2"	205

### Universal Joint

Chrome-Vanadium steel,  
chrome plated



Art. No.	square drive	length (mm)
2322003	3/8"	24
9201343	1/2"	36
9224923	3/4"	46

### Sliding T-Handle

Chrome-Vanadium steel,  
chrome plated



Art. No.	square drive	length (mm)
9208773	1/4"	115
9226913	3/8"	200
9200093	1/2"	300
9215153	3/4"	430

### Universal Joint

Chrome-Vanadium steel,  
chrome plated



Art. No.	square drive	length (mm)
9208803	1/4"	40
9224073	3/8"	58
9200123	1/2"	73

### Speeder Handle

Chrome-Vanadium steel,  
chrome plated



Art. No.	square drive	length (mm)
9200083	1/2"	375

# Torque Wrenches



## PADRE brand torque wrench with reversible ratchet-head

1/2", 3/8", 1/2", 3/4", chrome-vanadium steel

- double scale in N-m and lbf-ft divisions for precise adjustment
- actuation accuracy: +/- 3% tolerance of the set scale value
- large vision panel, precise adjustment using a magnifying glass
- an audible and palpable signal when desired torque value is achieved
- with exact gearing 30-teeth ratchet mechanism
- secure locking function within the handle
- square drive adaptor to DIN 3120 ISO 1174 with ball lock
- two-component handle with a soft zone, is ergonomic in design and comfortable in the hand



Art. No.	drive	Nm	graduation (Nm)	lbf.ft	length (mm)	weight (grs)
1965	1/4"	2 - 25	0,1	1,5 - 18	289	460
1966	3/8"	5 - 50	0,25	3,5 - 37	350	610
1967	1/2"	10 - 100	0,5	8 - 75	412	910
1968	1/2"	20 - 200	1	10 - 150	500	1300
1969	1/2"	60 - 300	1	45 - 220	585	1450
1971	3/4"	100 - 600	1	75 - 440	960	3800
1972	3/4"	150 - 800	10	110 - 960	1250	4800
1973	3/4"	200 - 1000	30	150 - 740	1500	5800

## PADRE brand torque wrench adaptor

Art. No.	size
909	1/4" to 3/8"
926	3/8" to 1/2"
962	1/2" to 3/4"
997	3/4" to 1"



## Ratchets & Tools assortments



### PADRE Metal Tool Boxes, green, 5-tray

consisting of: 102 pcs tools assortment,  
box with one handle and 1 brass padlock



Art. No. **1726 MM**

size: 530 x 200 x 200 mm

all sizes mm

Art. No. **1726 AF**

size: 530 x 200 x 200 mm

all sizes inch

### PADRE brand Ratchets

1/2" drive, according to DIN 3122  
chrome-vanadium steel, CV plated



Art. No.	length (mm)	weight (g)	version
947	280	490	reversible type
948	280	490	push type

### PADRE brand reversible Ratchets

1/2" drive, according to DIN 3122  
chrome-vanadium steel, CV plated



Art. No.	length (mm)	weight (g)	version
950H	250	490	lever type

### PADRE brand Socket Set Wrenches - 25 pcs/set

1/2" drive, chrome-vanadium steel  
metric, in metal case

Art. No.: **978 HS**

containing:

- 1 Sliding T-Handle No. 946 length: 300 mm
- 1 Reversible Ratchet No. 950H length: 250 mm
- 1 Universal Joint No. 955 length: 65 mm
- 1 Extension bar 125/250
- 20 Sockets 10, 11, 12, 13, 14, 15, 16, 17, 18, 19, 20, 21, 22, 23, 24, 25, 26, 27, 30, 32 mm



## Socket Sets

### PADRE brand Socket Set Wrenches - 26 pcs/set

1/2" drive, chrome-vanadium steel  
metric, in metal case

Art. No.: **979 HS**

containing:

- |                      |   |                |
|----------------------|---|----------------|
| 1 Speed braze        | No. 945   | length: 410 mm |
| 1 Sliding T-Handle   | No. 946   | length: 300 mm |
| 1 Reversible Ratchet | No. 950H  | length: 250 mm |
| 1 Universal Joint    | No. 955   | length: 65 mm  |
| 1 Extension bar      | 125/250   |                |
| 20 Sockets           | 10, 11, 12, 13, 14, 15, 16, 17,<br>18, 19, 20, 21, 22, 23, 24, 25,<br>26, 27, 30, 32 mm |                |



### Bit Socket Torx Set - 9 pcs/set

1/2" drive,  
in metal case



Art. No.	contents
986 T 9	969/-T20-T25-T27-T30-T40-T45-T50-T55-T60

### Bit Socket Hexagon Set - 9 pcs/set

1/2" drive, metric,  
in metal case



Art. No.	contents
986 S 9	967/-4-5-6-7-8-10-12-14-17

### PADRE brand Tubular box-spanners, nickel-plated



Art. No.	(mm)	length (mm)	Ø (mm)	Art. No.	(mm)	length (mm)	Ø (mm)
815	4x5	110	5,5	815	19x22	170	12,5
	6x7	110	5,5		19x24	180	12,5
	8x9	110	6,5		20x22	170	12,5
	8x10	120	6,5		21x23	170	14,5
	9x10	120	6,5		22x24	180	14,5
	9x11	120	6,5		22x27	180	14,5
	10x11	120	6,5		24x26	180	14,5
	10x13	140	6,5		24x27	180	14,5
	10x14	140	6,5		24x30	180	14,5
	11x13	140	6,5		25x28	180	16,3
	11x14	140	6,5		27x29	210	16,3
	12x13	140	8,5		27x30	210	16,3
	12x14	140	8,5		27x32	210	16,3
	13x14	140	8,5		30x32	210	16,3
	13x15	140	8,5		30x36	230	18,5
	13x17	150	10		32x36	230	18,5
	14x15	140	10		36x41	230	18,5
14x17	150	10	41x46	250	21		
16x17	150	10	46x50	250	21		
17x19	160	12,5	50x55	280	21		
17x22	170	12,5	55x60	280	21		
18x19	160	12,5					

## Rim Wrenches

### Single Ended Wheel Nut Wrenches

for trucks, special tool steel, silver lacquered



Art. No.	size	length
72 3112 019	19 mm	265 mm
72 3112 022	22 mm	360 mm
72 3112 024	24 mm	360 mm
72 3112 027	27 mm	400 mm
72 3112 030	30 mm	400 mm
72 3112 032	32 mm	400 mm
72 3112 033	33 mm	400 mm
72 3112 036	36 mm	400 mm

### Double Ended Wheel Nut Wrenches

for trucks, special tool steel, silver lacquered  
length 400 mm



#### a) 6-point on both sides

Art. No.	size
70 5000 002	24 x 27 mm
70 5700 002	27 x 30 mm
70 5500 002	27 x 33 mm
70 5800 002	30 x 32 mm
70 5900 002	30 x 33 mm
70 9590 002	32 x 33 mm



#### b) 6-point / 6-point + 4-point / square drive (13/16")

Art. No.	size
70 3210 002	38 x 32 mm
70 3300 002	1.1/16 x 1.1/4"
70 3310 002	27 x 32 mm
70 3400 002	1.1/8 x 1.1/8"
70 3100 002	1.1/8" x 1.1/2"
70 3200 002	1.1/4" x 1.1/2"



#### c) 4-point / 6-point

Art. No.	size
70 1307 002	17 x 32 mm
70 1306 002	17 x 35 mm
70 1304 002	21 x 38 mm
70 1302 002	21 x 41 mm



### Cross Wheel Wrenches

made from special tool steel, silver lacquered



#### a) for trucks

**Art. No.: 70 2000 000**

24 x 27 x 38 x 32 mm (13/16")  
15/16 x 1.1/16 x 1.1/2 x 1.1/4" (13/16")

#### b) for trucks

**Art. No.: 72 2000 000**

19 x 22 x 24 x 27 mm  
3/4 x 7/8 x 15/16 x 1.1/16"

#### c) for cars

**Art. No.: 70 0150 800**

17 x 19 x 22 mm x 1/2"

#### d) for cars

**Art. No.: 70 0100 000**

17 x 19 x 22 mm x 13/16" (outside 4-point/square)



### Tommy Bars

fully hardened, 18 x 500 mm, silver lacquered

**Art. No.: 70 3010 102**





# Tyre Levers & Pry Bars



## Tyre Levers - Mounting Bars

forged and both ends heat treated

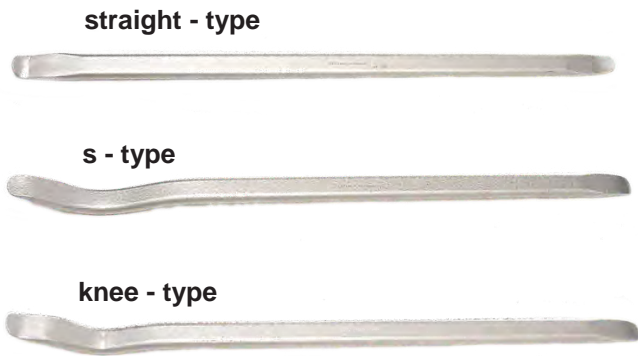

straight - type		s - type		knee - type	
Art. No.	length	Art. No.	length	Art. No.	length (mm)
2101/1	150				
2101/2	200				
2101/3	300	2104/3	300	2106/3	300
2101/4	400	2104/4	400	2106/4	400
2101/5	500	2104/5	500	2106/5	500
2101/6	600	2104/6	600	2106/6	600
2101/7	700	2104/7	700	2106/7	700

## Tyre Levers - HEYCO brand

forged and both ends heat treated

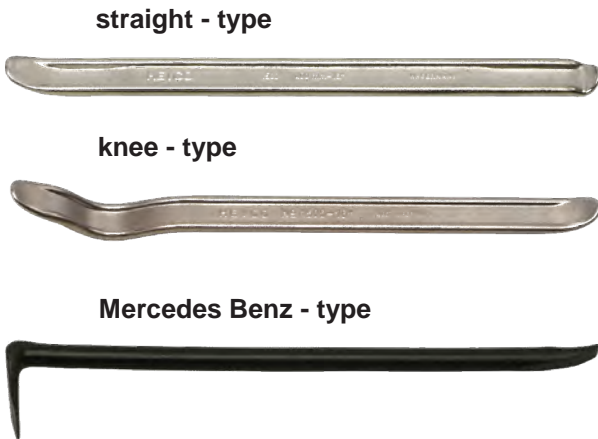

straight - type		knee - type		Mercedes Benz - type		
Art. No.	length	Art. No.	length	Art. No.	length	ref.-No.
1500030080	300					
1500040080	400	1505040080	400			
				1509045020	450	0005811758
1500050080	500	1505050080	500			
1500060080	600	1505060080	600	1509060020	600	0005812158

### rim assembling lever



### rim dismantling lever



## KISTENMACHER Tyre Levers - (TRILEX - type)

length 500 mm

Art. No.	description
01 3400 700	rim assembling lever
01 3400 200	rim assembling lever

## Tyre Lever Sets - (TRILEX - type)

consisting of assembling & dismantling lever

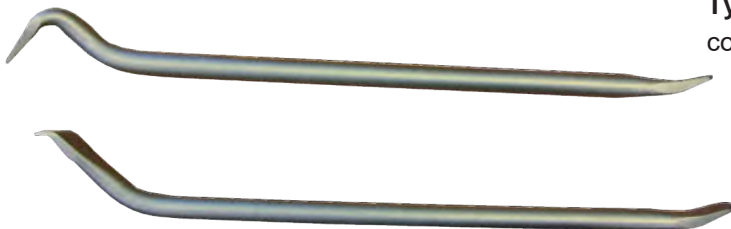

Art. No.	size (mm)
140846020	600 x 20

## Pry Bar Standard Ø 14 mm

chrome vanadium steel, silver painted



Art. No.	length (mm)	
6815	400	round shaft
6810	400	square shaft

# Pullers



## Standard Pullers - No. 10 2-arm mechanical Type



pulling legs, drop forged, in one piece. therefore guaranteed non bending even by extremely hard work. for swift and safe removal of wheels of any description, gears, races, ball bearings, pulleys etc.

Art. No.	size (mm)	size (mm)
10/1	15-85	100
10/1A	15-125	100
10/2	20-160	150
10/2A	20-200	150
10/3	40-250	200
10/3A	40-350	200
10/4	40-530	200



## Standard Pullers - No. 13 3-arm mechanical Type

strong triple grip puller with parallel movable legs. can be used for external and also for internal work by simply turning pulling legs. triple grip puller cannot tip over even by extreme use.

important notice: pulling legs, extensions and all other equipment of standard twin grip pullers can be used in conjunction with our

No. 13 triple grip pullers.

Art. No.	size (mm)	size (mm)
13/1A	15-120	100
13/2	20-160	150
13/2A	20-220	150

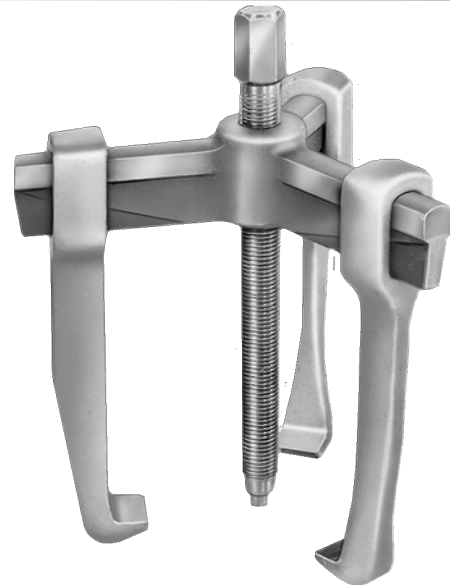

## Universal Pullers - No. 16/17

strong universal triple grip puller with parallel movable legs and large spread. can be used for inside or outside operations. the triple grip puller cannot tip over even by extreme use.

### 2-arm mechanical type

Art. No.	size (mm)	size (mm)
16/1	25-80	100
16/1A	25-130	100
12/2	50-160	150
16/2A	60-200	150
16/3	80-250	200
16/3A	80-350	200
16/4	110-250	200
16/5	170-640	225

### 3-arm mechanical type

Art. No.	size (mm)	size (mm)
17/1	25-80	100
17/1A	25-120	100
17/2	50-160	150
17/2A	60-200	150
17/3A	100-380	200
17/4	120-250	200
17/5	120-640	200



# Pullers



## Universal Pullers - No. 20/21



strong universal triple grip puller with parallel movable legs and large spread. can be used for inside or outside operations. the triple grip puller cannot tip over even by extreme use.

### 2-arm mechanical type

### 3-arm mechanical type

Art. No.	size (mm)	size (mm)	Art. No.	size (mm)	size (mm)
20/1	20-150	80	21/1	20-150	80
20/2	40-200	130	21/2	40-200	130



## Universal Pullers - No. 22/23

of sturdy yet well balanced construction for all types of application, simply to operate, very wide range. self-locking system prevents slipping of jaws. more pressure by forcing screw automatically increases grip of jaws. mechanical centre screws are interchangeable with hydraulic rams.

### 2-arm mechanical type

### 3-arm mechanical type

Art. No.	size (mm)	size (mm)	Art. No.	size (mm)	size (mm)
22/01	15-85	85	23/01	15-85	85
22/0	20-120	120	23/0	20-120	120
22/1	20-165	145	23/1	20-165	145
22/2	35-230	220	23/2	35-230	220
22/3	50-300	270	23/3	50-300	270
22/4	50-400	400	23/4	50-400	400
22/5	50-500	500	23/5	50-500	500
22/6	55-650	500	23/6	55-650	500



## Universal Puller Sets - No. K22/60

this illustration shows separator with universal puller separating two closely placed gear wheels. they can then easily be pulled off from the shaft.

set consisting of each 1 pc in metal case:

- Universal puller No. 22/1, 22/2
- Separators No. 60/1, 60/2
- Cross-beam No. 23/1K, 23/2K
- 1 Pulling Leg, compl. No. 22/1H, 22/2H

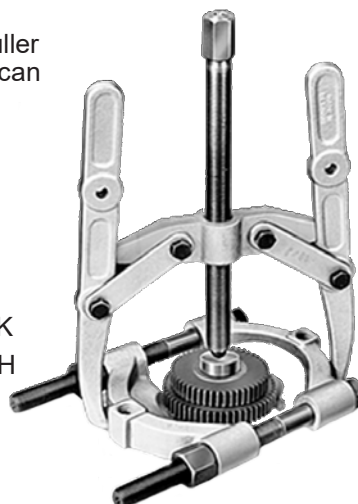

## Pullers



### Heavy Pullers - No. 24/25/26/27 mechanical type



exceptionally strong design combined with large capacity. universal use as pulling legs are interchangeable. a puller with 5 legs can easily be made into a 4-, 3- or 2-leg puller. in case of spoke wheels it is advisable to insert legs between spokes on the hub. our powerful hydraulic pullers are specially recommended for all industrial maintenance and repair work.



2-arm mechanical type			3-arm mechanical type			4-arm mechanical type			5-arm mechanical type		
Art. No.	size (mm)	size (mm)	Art. No.	size (mm)	size (mm)	Art. No.	size (mm)	size (mm)	Art. No.	size (mm)	size (mm)
24/1	50-350	325	25/1	60-350	325	26/1	70-350	325	27/1	80-350	325
24/2	60-500	500	25/2	60-500	500	26/2	70-500	500	27/2	80-500	500

### Pullers - No. 36/37

a small very handy inexpensive puller designed for any light work. the unique self-locking device enables arms to be pressed tightly against parts to be pulled.

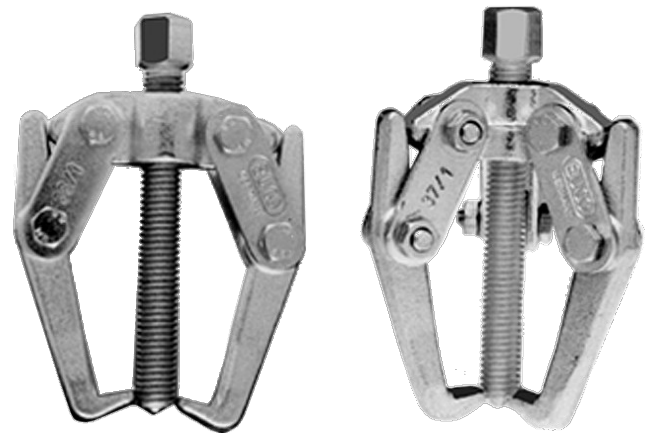

2-arm mechanical type			3-arm mechanical type		
Art. No.	size (mm)	size (mm)	Art. No.	size (mm)	size (mm)
36/1	10-55	40	37/1	10-55	40
36/2	10-75	65	37/2	10-75	65

### Battery Terminal Pullers - No. 40

a small very handy puller for battery service, electrical appliances, small motors, ball bearings, gears, etc. the ideal -one hand- application allows swift safe and easy use. automatic clamping of pulling legs by spring pressure. once in position no slipping-off possible.



2-arm mechanical type		
Art. No.	size (mm)	size (mm)
40/1	10-55	45
40/2	10-70	65

## Pullers

### Pullers - No. 92/93

handy little pullers with self-centering function and automatically adjusting pulling legs. The higher the increasing pressure of the spindle, the firmer the clamping pressure of the pulling legs.



#### 2-arm type

#### 3-arm type

Art. No.	size (mm)	size (mm)	Art. No.	size (mm)	size (mm)
92/1	10-60	45	93/1	10-60	45
92/2	10-70	65	93/2	10-70	65
92/3	10-100	80	93/3	10-100	80



2-arm type

3-arm type

### Pullers - No. 94/95

handy little pullers with self-centering function and automatically adjusting pulling legs. the higher the increasing pressure of the spindle, the firmer the clamping pressure of the pulling legs.

#### 2-arm type

#### 3-arm type

Art. No.	size (mm)	size (mm)	Art. No.	size (mm)	size (mm)
94/1	10-100	80	95/1	10-100	80
94/2	10-120	120	95/2	10-120	120
94/3	20-160	160	95/3	20-160	160
94/4	20-220	200	95/4	20-220	200



2-arm type

3-arm type

### Ball Joint Pullers - No. 180

for easy and swift removal of ball pins from the tapered housing on steering arms.



Art. No.	opening (mm)	width (mm)	height (mm)
180/2	18	37	37
180/3	23	45	45
180/4	29	55	60
180/5	39	70	80
180/6	46	90	100

### Ball Joint Puller - No. 183

very handy, many sided and specially suited for where lack of space forbids entry of direct models



Art. No.	opening (mm)	height (mm)
183/1	22	20-50

# Pullers & Separators



## Separators - No. 60

indispensable for the removal of races, bearings, gear wheels etc. from hubs, shafts, where space is limited. the flat sides of separator halves give ample all round support.

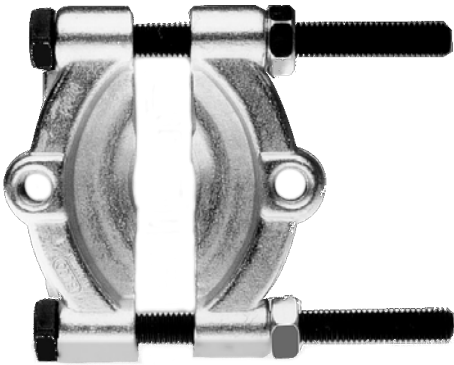

Art. No.	opening (mm)	for use with pulling units
60/0	5 - 60	B10/1 + B10/1A. 62/0
60/1	12 - 75	B10/1A. 62/1
60/2	22 - 150	B10/2 + B10/2A. 62/2
60/3	30 - 155	B10/3 + B10/3A. 62/3
60/4	30 - 200	B10/3A. 62/4
60/5	40 - 280	62/5

## Pulling Units - No. B10

for separators and thread adaptors



Art. No.	width (mm)	length / mm)	for use with separators
B10/1	100	110	60/0
B10/1A	130	110	60/1
B10/2	165	185	60/2
B10/2A	205	185	60/2
B10/3	260	260	60/3
B10/3A	355	260	60/3 60/4
B10/4	530	260	60/3 60/4

## Pulling Units - No. 62

for separators and thread adaptors



Art. No.	width (mm)	length / mm)	for use with Separators
62/0	45 - 110	110	60/0
62/1	55 - 140	155	60/1
62/2	60 - 215	200	60/2
62/3	85 - 295	315	60/2
62/4	120 - 350	305	60/3 60/4
62/5	140 - 435	320	60/5

## Sets: Separators No. 60 + Pulling Unit No. B10 mechanical type



Art. No.	opening (mm)	width (mm)
60/0 + B10/1	5 - 60	100
60/1 + B10/1A	12 - 75	130
60/2 + B10/2	22 - 150	165
60/3 + B10/3	30 - 155	260
60/4 + B10/3A	30 - 200	530

## Puller & Coil Spring Sets



### Puller Sets

in metal case, consisting of:  
pulling unit - extension (pair) - separator



Art. No.	contents
K60/0	B10/1 - 60/0 - ZBV/1
K60/1	B10/1A - 60/1 - ZBV/1
K60/2	B10/2 - 60/2 - ZBV/2
K60/3	B10/3 - 60/3 - ZBV/3
K60/4	B10/3A - 60/4 - ZBV/3

Art. No.	contents
K62/0	62/0 - 60/0 - ZBV/1
K62/1	62/1 - 60/1 - ZBV/1
K62/2	62/2 - 60/2 - ZBV/2
K62/3	62/3 - 60/3 - ZBV/3
K62/4	62/4 - 60/4 - ZBV/3



### Coil Spring Compressor Sets

for quick and safe mounting or removal of all usual coils. the simple yet safe clamping device avoids the breaking away of the spring while working.

it is advisable to use 3 spring compressors simultaneously evenly placed. this will avoid sagging of spring.

long and short spindles are interchangeable.

Art. No.: 909/1	- 2 pcs.	<b>size: 200 mm</b>
Art. No.: 909/2	- 2 pcs.	<b>size: 300 mm</b>
Art. No.: 909/3	- 2 pcs.	<b>size: 400 mm</b>



## Hammers

**Plastic Hammers with yellow or red transparent heads**  
made of shock proof cellulose-acetate,  
ash wood handle



Art. No. red	Art. No. yellow	length (mm)	dia. (mm)	pcs/ carton
100/22	101/22	250	22	6
100/27	101/27	270	27	6
100/32	101/32	280	32	6
100/35	101/35	290	35	6
100/40	101/40	320	40	6
100/50	101/50	340	50	6
100/60	101/60	370	60	2

**Nylon Hammers with white/milky heads**  
made of shock proof nylon,  
ash wood handle



Art. No. white	length (mm)	dia. (mm)	pcs/ carton
102/22	250	22	6
102/27	270	27	6
102/32	280	32	6
102/35	290	35	6
102/40	320	40	6
102/50	340	50	6
102/60	370	60	2

**Spare Heads for Plastic Hammers, yellow**  
made from shock proof cellulose-acetate, (1 pair)



Art. No. yellow	dia. (mm)
1925/22	22
1925/27	27
1925/32	32
1925/35	35
1925/40	40
1925/50	50
1925/60	60

**Spare Heads for Nylon Hammers, white/milky**  
made from nylon, (1 pair)



Art. No. yellow	length (mm)	dia. (mm)
1926/22	250	22
1926/27	270	27
1926/32	280	32
1926/35	290	35
1926/40	320	40
1926/50	340	50
1926/60	370	60

### Rubber Mallets

with flat faces, ash wood handle



Art. No.	weight (g)	head size (mm)
571.1	160	80 x 40
571.2	340	90 x 54
571.3	550	110 x 65
571.4	750	127 x 75
571.5	1250	140 x 90

### PICARD brand Cross Pein and Finishing Hammer

with extra wide and thin face

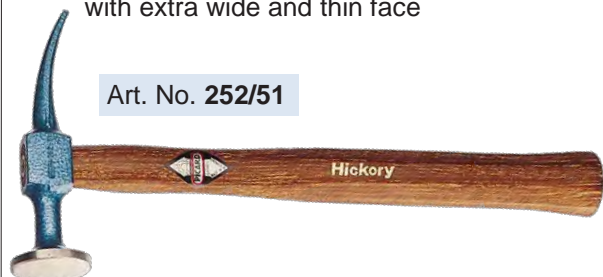

### PICARD brand Cross Pein and Finishing Hammer

with extra wide and thin face, with straight pein

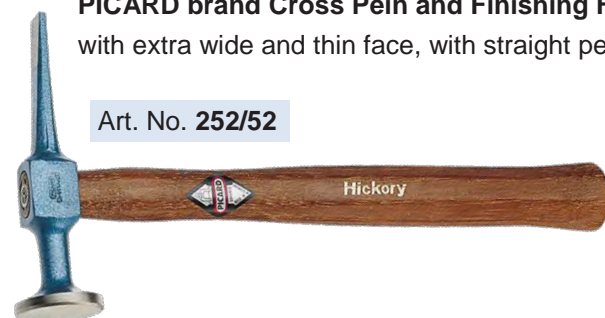



# Bumping Tools



**PICARD brand Bumping Tool Sets**

9 pcs per set, in sheet iron boxes

Art. No. **0025200**



**PICARD brand Bumping Tool Sets**

Art. No. **0025900**



**PICARD brand Bumping Tool Sets**

25 pcs per set, in sheet iron boxes, 3 compartments

Art. No. **0026000**



**PICARD brand Bumping Tool Sets**

30 pcs per set, in sheet iron boxes, 3 compartments

Art. No. **0025400**



**PICARD brand Inside Pry and Surfacing Spoon**

small pattern

Art. No. **2521800**



Art. No. **2521890**



**PICARD brand Pry and Bumping Spoon**

Art. No. **2521990**



**PICARD brand Anvil Blocks**

Art. No. **252/15** rooffe wedge



Art. No. **252/40** toe pattern



# Grips



## Grips with Wire Cutters

with drop-forged chrome vanadium steel jaws, used for round and flat materials



Art. No.	length (mm)	weight (g)	capacity (mm)
0100-0105	140	170	30
0100-0106	180	355	35
0100-0110	250	545	50
0100-0112	300	900	65

also available with extra wide red PVC coated quick-release lever



Art. No.	length (mm)	weight (g)	capacity (mm)
0100-1111	250	550	50

## Grips with Straight Drop-forged Jaws

of chrome vanadium steel, used for flat materials



Art. No.	length (mm)	weight (g)	capacity (mm)
0200-0207	180	305	35
0200-0210	250	510	40

## Ideal Grips

with drop-forged chrome vanadium steel jaws, used for flat, round, shaped and square materials



Art. No.	length (mm)	weight (g)	capacity (mm)
0250-0251	180	370	35
0250-0252	250	575	50

## Prisma Grips

with drop-forged chrome vanadium steel jaws, used for round and flat materials



Art. No.	length (mm)	weight (g)	capacity (mm)
0110-0118	180	350	30
0110-0125	250	555	35
0110-0130	300	900	50

## Grips

### Parallel Plus Grips

with drop-forged chrome vanadium steel jaws, used for round and flat materials



Art. No.	length (mm)	weight (g)	capacity (mm)
0150-0150	250	580	45

### Parallel Grips

with drop-forged chrome vanadium steel jaws, used for flat and shaped materials



Art. No.	length (mm)	weight (g)	capacity (mm)
0160-0160	250	700	50

### Welding Grips with Jaws

of chrome vanadium steel



Art. No.	length (mm)	weight (g)	capacity (mm)
0300-0300	280	790	60
0300-0301	280	935	70

### Grips for Tubes with Jaws

of chrome vanadium steel



Art. No.	length (mm)	weight (g)	capacity (mm)
0320-0320	280	790	10-90
0320-0321	280	935	10-90

### Long-Nose-Grips for sheet metal

of chrome vanadium steel, ideal for clamping, bending and crimping of thin and soft sheet metals



Art. No.	length (mm)	weight (g)	capacity (mm)
0370-0370	180	470	45

## Grips



### C-Clamp Grips

with drop-forged chrome vanadium steel jaws



Art. No.	length (mm)	weight (g)	capacity (mm)
0340-0340	175	235	50
0340-0341	280	710	90
0340-0342	460	1090	220
0340-0343	610	1345	410
0340-0344	510	1520	500

### Parallel C-Clamp Grips

with movable jaws



Art. No.	length (mm)	weight (g)	capacity (mm)
0350-0351	280	780	90
0350-0352	460	1170	225
0350-0353	600	1415	295

### Long Nose Grips

with drop-forged chrome vanadium steel jaws, used for gripping in tapering spaces



Art. No.	length (mm)	weight (g)	capacity (mm)
0360-0360	165	180	40
0360-0361	240	380	55

### Chain Grip Cutters - for steel, copper or PVC

with drop-forged chrome vanadium steel jaws, used for large and asymmetric workpieces



Art. No.	length (mm)	weight (g)	capacity (mm)
0280-0280	250	930	150

# Strap & Filter Wrenches, Piston Ring Compressors



## Strap Wrenches

bright nickel plated,  
with plastic coated handle,  
with non-slip textile strap

Art. No.	length (mm)	capacity (mm)
0740-0741	230	160
0740-0742	230	240

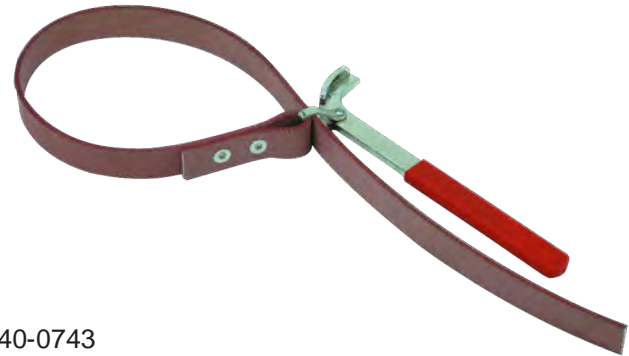

Replacement straps for 160 mm cap.  
Replacement straps for 240 mm cap.

Art. No. 0740-0743  
Art. No. 0740-0744

## Strap Wrenches

chromium-plated with forged handle,  
made of chrome-vanadium-steel,  
with non-slip textile strap

Art. No.	length (mm)	capacity (mm)
0740-0745	280	280



Replacement straps for 280 mm cap.

Art. No. 0740-0746

## Piston Ring Compressors

with infinitely variable regulation,  
special spring steel, tightening  
strap blue

Art. No.	length (mm)	capacity (mm)
0700-0701	80	57-125
0700-0711	100	57-125
0700-0702	80	90-175
0700-0721	100	90-175
0700-0703	165	90-175





## Filter Wrenches & Valve Spring Compressors



### Filter Wrenches

bright nickel plated  
with plastic coated handle



Art. No.	length (mm)	capacity (mm)
0760-0763	220	60-80
0760-0764	240	75-110

### Filter Wrenches

bright nickel plated  
with 1/2" square drive



Art. No.	length (mm)	capacity (mm)
0760-0761	130	60-80
0760-0762	150	75-110

### Filter Wrenches

bright nickel plated  
with plastic coated handle



Art. No.	length (mm)	capacity (mm)
0760-0773	210	60-80
0760-0774	230	75-110

### Filter Wrenches

bright nickel plated  
with 1/2" square drive



Art. No.	length (mm)	capacity (mm)
0760-0771	140	65-80
0760-0772	160	75-110

### Piston Ring Pliers

bright nickel plated, for  
removal and fitting of piston  
rings

Art. No.	length (mm)	capacity (mm)
0600-0601	200	50-100
0600-0602	240	90-150



### Valve Spring Compressors

bright nickel plated, for light vehicle engines

Art. No.	length (mm)	capacity (mm)	version
0500-0500	290	70-225	straight jaws

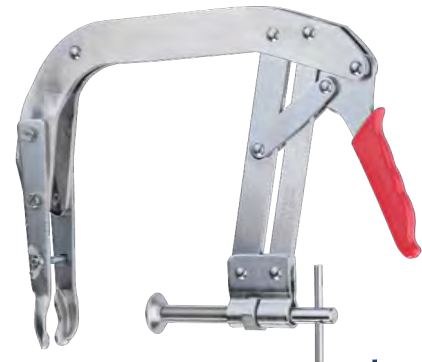

Replacement jaws, straight, pair

Art. No. 0500-0511

## Allen Keys

### Hexagon Key Wrenches ISO 2936

chrome vanadium steel - Type 200  
available in black colour and nickel plated



metric size

inch size

Art. No. black	Art. No. nickel plated	Ø mm	Art. No. black	Art. No. nickel plated	Ø inch
200-015-01	200-015-02	1.5	200-364-51	200-364-52	3/64
200-020-01	200-020-02	2	200-005-51	200-005-52	0,05
200-025-01	200-025-02	2.5	200-116-51	200-116-52	1/16
200-030-01	200-030-02	3	200-564-51	200-564-52	5/64
200-035-01	200-035-02	3.5	200-332-51	200-332-52	3/32
200-040-01	200-040-02	4	200-764-51	200-764-52	7/64
200-045-01	200-045-02	4.5	200-180-51	200-180-52	1/8
200-050-01	200-050-02	5	200-964-51	200-964-52	9/64
200-055-01	200-055-02	5.5	200-532-51	200-532-52	5/32
200-060-01	200-060-02	6	200-316-51	200-316-52	3/16
200-070-01	200-070-02	7	200-732-51	200-732-52	7/32
200-080-01	200-080-02	8	200-140-51	200-140-52	1/4
200-090-01	200-090-02	9	200-932-51	200-932-52	9/32
200-100-01	200-100-02	10	200-516-51	200-516-52	5/16
200-110-01	200-110-02	11	200-113-51	200-113-52	11/32
200-120-01	200-120-02	12	200-380-51	200-380-52	3/8
200-130-01	200-130-02	13	200-716-51	200-716-52	7/16
200-140-01	200-140-02	14	200-120-51	200-120-52	1/2
200-150-01	200-150-02	15	200-916-51	200-916-52	9/16
200-160-01	200-160-02	16	200-580-51	200-580-52	5/8
200-170-01	200-170-02	17	200-340-51	200-340-52	3/4
200-180-01	200-180-02	18	200-780-51	200-780-52	7/8
200-190-01	200-190-02	19	200-100-51	200-100-52	1
200-200-01	200-200-02	20			
200-210-01	200-210-02	21			
200-220-01	200-220-02	22			
200-240-01	200-240-02	24			
200-270-01	200-270-02	27			
200-300-01	200-300-02	30			
200-320-01	200-320-02	32			
200-360-01	200-360-02	36			
200-400-01		40			
200-460-01		46			
200-500-01		50			
200-550-01		55			

### Hexagon Key Wrenches ISO 2936L

**EXTRA LONG** chrome vanadium steel - Type 210  
available in black colour and nickel plated



metric size

inch size

Art. No. black	Art. No. nickel plated	Ø mm	Art. No. black	Art. No. nickel plated	Ø inch
210-015-01	210-015-02	1.5	210-364-51	210-364-52	3/64
210-020-01	210-020-02	2	210-005-51	210-005-52	0,05
210-025-01	210-025-02	2.5	210-116-51	210-116-52	1/16
210-030-01	210-030-02	3	210-564-51	210-564-52	5/64
210-035-01	210-035-02	3.5	210-332-51	210-332-52	3/32
210-040-01	210-040-02	4	210-764-51	210-764-52	7/64
210-045-01	210-045-02	4.5	210-180-51	210-180-52	1/8
210-050-01	210-050-02	5	210-964-51	210-964-52	9/64
210-055-01	210-055-02	5.5	210-532-51	210-532-52	5/32
210-060-01	210-060-02	6	210-316-51	210-316-52	3/16
210-070-01	210-070-02	7	210-732-51	210-732-52	7/32
210-080-01	210-080-02	8	210-140-51	210-140-52	1/4
210-090-01	210-090-02	9	210-932-51	210-932-52	9/32
210-100-01	210-100-02	10	210-516-51	210-516-52	5/16
210-110-01	210-110-02	11	210-113-51	210-113-52	11/32
210-120-01	210-120-02	12	210-380-51	210-380-52	3/8
210-130-01	210-130-02	13	210-716-51	210-716-52	7/16
210-140-01	210-140-02	14	210-120-51	210-120-52	1/2
210-150-01	210-150-02	15	210-916-51	210-916-52	9/16
210-160-01	210-160-02	16	210-580-51	210-580-52	5/8
210-170-01	210-170-02	17	210-340-51	210-340-52	3/4
210-180-01	210-180-02	18	210-780-51	210-780-52	7/8
210-190-01	210-190-02	19	210-100-51	210-100-52	1
210-200-01	210-200-02	20			
210-220-01	210-220-02	22			
210-240-01	210-240-02	24			
210-270-01	210-270-02	27			



## Allen Key Sets

### Hexagon Key Wrench Sets ISO 2936

chrome vanadium steel - Type 230  
each set packed in plastic wallet



#### metric sizes

Art. No. black	Art. No. nickel plated	pcs per set	sizes (mm)
230-186-01	230-186-02	8	1.5, 2, 2.5, 3, 4, 5, 5.5, 6
230-190-01S	230-190-02S	9	1.5, 2, 2.5, 3, 4, 5, 6, 8, 10
230-192-01	230-192-02	9	2, 2.5, 3, 4, 5, 6, 8, 10, 12
230-102-01S	230-102-02S	10	1.5, 2, 2.5, 3, 4, 5, 6, 8, 10, 12
230-102-01	230-102-02	10	2, 2.5, 3, 4, 5, 5.5, 6, 8, 10, 12
230-114-01	230-114-02	11	2, 2.5, 3, 4, 5, 5.5, 6, 8, 10, 12, 14

### Hexagon Key Wrench Sets ISO 2936

chrome vanadium steel - Type 230  
each set packed in plastic wallet



#### inch sizes

Art. No. black	Art. No. nickel plated	pcs per set	sizes (inch)
230-284-51	230-284-52	8	1/16, 5/64, 3/32, 1/8, 5/32, 3/16, 7/32, 1/4
230-298-51S	230-298-52S	9	1/16, 5/64, 3/32, 1/8, 5/32, 3/16, 1/4, 5/16, 3/8
230-298-51	230-298-52	9	5/64, 3/32, 1/8, 5/32, 3/16, 7/32, 1/4, 5/16, 3/8
230-202-51S	230-202-52S	10	1/16, 5/64, 3/32, 1/8, 5/32, 3/16, 1/4, 5/16, 3/8, 1/2
230-202-51	230-202-52	10	5/64, 3/32, 1/8, 5/32, 3/16, 7/32, 1/4, 5/16, 3/8, 1/2
230-216-51	230-216-52	11	5/64, 3/32, 1/8, 5/32, 3/16, 7/32, 1/4, 5/16, 3/8, 1/2, 9/16

### Hexagon Key Wrench Sets ISO 2936

chrome vanadium steel - Type 238  
each set packed on plastic clip



#### metric sizes

#### inch sizes

Art. No. black	Art. No. nickel plated	pcs per set	sizes (mm/inch)
238-376-01	238-376-02	7	1.5, 2, 2.5, 3, 4, 5, 6
238-390-01	238-390-02	9	1.5, 2, 2.5, 3, 4, 5, 6, 8, 10
238-302-01	238-302-02	10	1.5, 2, 2.5, 3, 4, 5, 6, 8, 10, 12
238-474-51	238-474-52	7	1/16, 5/64, 3/32, 1/8, 5/32, 3/16, 1/4
238-498-51	238-498-52	9	1/16, 5/64, 3/32, 1/8, 5/32, 3/16, 1/4, 5/16, 3/8
238-402-51	238-402-52	10	1/16, 5/64, 3/32, 1/8, 5/32, 3/16, 1/4, 5/16, 3/8, 1/2



# Allen Key Sets - Extra Long



## Hexagon Key Wrench Sets ISO 2936L

**EXTRA LONG** - chrome vanadium steel - Type 213  
each set packed in plastic wallet



metric sizes

Art. No. black	Art. No. nickel plated	pcs per set	sizes (mm)
213-188-01	213-188-02	8	1.5, 2, 2.5, 3, 4, 5, 6, 8
213-180-01	213-180-02	8	2, 2.5, 3, 4, 5, 6, 8, 10
213-190-01	213-190-02	9	1.5, 2, 2.5, 3, 4, 5, 6, 8, 10
213-192-01	213-192-02	9	2, 2.5, 3, 4, 5, 6, 8, 10, 12
213-102-01	213-102-02	10	1.5, 2, 2.5, 3, 4, 5, 6, 8, 10, 12



## Hexagon Key Wrench Sets ISO 2936L

**EXTRA LONG** - chrome vanadium steel - Type 213  
each set packed in plastic wallet



inch sizes

Art. No. black	Art. No. nickel plated	pcs per set	sizes (inch)
213-286-51	213-286-52	8	1/16, 5/64, 3/32, 1/8, 5/32, 3/16, 1/4, 5/16
213-288-51	213-288-52	8	5/64, 3/32, 1/8, 5/32, 3/16, 1/4, 5/16, 3/8
213-298-51	213-298-52	9	1/16, 5/64, 3/32, 1/8, 5/32, 3/16, 1/4, 5/16, 3/8
213-292-51	213-292-52	9	5/64, 3/32, 1/8, 5/32, 3/16, 1/4, 5/16, 3/8, 1/2
213-202-51	213-202-52	10	1/16, 5/64, 3/32, 1/8, 5/32, 3/16, 1/4, 5/16, 3/8, 1/2



## Hexagon Key Wrench Sets ISO 2936L

**EXTRA LONG** - chrome vanadium steel - Type 211  
each set packed on plastic clip



metric sizes

Art. No. black	Art. No. nickel plated	pcs per set	sizes (mm)
211-390-01	211-390-02	9	1.5, 2, 2.5, 3, 4, 5, 6, 8, 10
211-302-01	211-302-02	10	1.5, 2, 2.5, 3, 4, 5, 6, 8, 10, 12



inch sizes

Art. No. black	Art. No. nickel plated	pcs per set	sizes (inch)
211-498-51	211-498-52	9	1/16, 5/64, 3/32, 1/8, 5/32, 3/16, 1/4, 5/16, 3/8
211-402-51	211-402-52	10	1/16, 5/64, 3/32, 1/8, 5/32, 3/16, 1/4, 5/16, 3/8, 1/2



# Allen Key Sets



## Hexagon Key Wrenches with ballpoint

**EXTRA LONG** - chrome vanadium steel - Type 413  
each set packed in plastic wallet

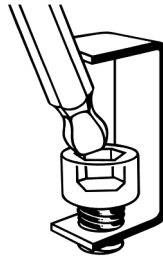

metric sizes

Art. No. nickel plated	Art. No. steel grey	pcs per set	sizes (mm)
413-166-02	413-166-08	6	2, 2.5, 3, 4, 5, 6
413-176-02	413-176-08	7	1.5, 2, 2.5, 3, 4, 5, 6
413-180-02	413-180-08	8	2, 2.5, 3, 4, 5, 6, 8, 10
413-190-02	413-190-08	9	1.5, 2, 2.5, 3, 4, 5, 6, 8, 10
413-102-02	413-102-08	10	1.5, 2, 2.5, 3, 4, 5, 6, 8, 10, 12



inch sizes

Art. No. nickel plated	Art. No. steel grey	pcs per set	sizes (inch)
413-274-52	413-274-58	7	5/64, 3/32, 1/8, 5/32, 3/16, 7/32, 1/4
413-298-52	413-298-58	9	5/64, 3/32, 1/8, 5/32, 3/16, 7/32, 1/4, 5/16, 3/8
413-202-52	413-202-58	10	1/16, 5/64, 3/32, 1/8, 5/32, 3/16, 1/4, 5/16, 3/8, 1/2



## Hexagon Key Wrenches with ballpoint

**LONG** - chrome vanadium steel - Type 451  
each set packed on plastic clip

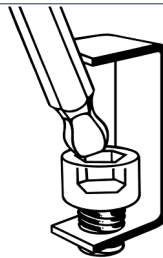

metric sizes

Art. No. nickel plated	Art. No. steel grey	pcs per set	sizes (mm)
451-365-02	451-365-08	6	1.5, 2, 2.5, 3, 4, 5
451-376-02	451-376-08	7	1.5, 2, 2.5, 3, 4, 5, 6
451-390-02	451-390-08	9	1.5, 2, 2.5, 3, 4, 5, 6, 8, 10
451-302-02	451-302-08	10	1.5, 2, 2.5, 3, 4, 5, 6, 8, 10, 12



inch sizes

Art. No. nickel plated	Art. No. steel grey	pcs per set	sizes (inch)
451-498-52	451-498-58	9	1/16, 5/64, 3/32, 1/8, 5/32, 3/16, 1/4, 5/16, 3/8
451-402-52	451-402-58	10	1/16, 5/64, 3/32, 1/8, 5/32, 3/16, 1/4, 5/16, 3/8, 1/2



## Allen Key Sets



### TORX Key Wrenches

chrome vanadium steel - Type 525  
each set packed in plastic wallet



Art. No. nickel plated	Art. No. steel grey	pcs per set	sizes (TX)
525-180-02	525-180-08	8	TX 9, 10, 15, 20, 25, 27, 30, 40



### TORX Key Wrenches

**EXTRA LONG** - chrome vanadium steel - Type 551  
each set packed in plastic clip



Art. No.	pcs per set	sizes (TX)
551-180-08	8	TX 9, 10, 15, 20, 25, 27, 30, 40
551-190-08	9	TX 10, 15, 20, 25, 27, 30, 40, 45, 50



### KISTENMACHER brand - Hand Clip Allen Key Set

chrome vanadium steel, black finish - nickel plated  
metal hand clip

Art. No.	pcs per set	sizes (TX)
2937-45/7210	7	2.5, 3, 4, 5, 6, 8, 10 mm
2937-45/7211	7	1/16, 5/64, 3/32, 1/8, 5/32, 3/16, 7/32"
2937-45/7220	8	TX 09, 10, 15, 20, 25, 27, 30, 40
2937-45/7221	8	TX 09, 10, 15, 20, 25, 27, 30, 40 - Tamper proof





## Allen Key Sets & Offset Screwdrivers



### KISTENMACHER brand Allen Key Set

chrome vanadium steel, nickel plated, each set packed in PVC box packing (red/black Flexbox)

Art. No.	pcs per set	version	sizes
43KL/5KM	9	short type	1.5, 2, 2.5, 3, 4, 5, 6, 8, 10 mm
43KL/7KM	9	long type	1.5, 2, 2.5, 3, 4, 5, 6, 8, 10 mm
43KL/8KM	9	long type, ballpoint	1.5, 2, 2.5, 3, 4, 5, 6, 8, 10 mm
43KL/10KM	9	short type	TX 8, 9, 10, 15, 20, 25, 27, 30, 40
43/KL/11KM	9	short type	TX 9, 10, 15, 20, 25, 27, 30, 40, 45
43/KL/16KM	9	short type, ballpoint	TX 8, 9, 10, 15, 20, 25, 27, 30, 40



### Offset Screwdrivers, DIN 5200

for slotted head screws, chrome vanadium steel, nickel plated

Art. No.	length (mm)	width of blade (mm)	Ø shaft (mm)
	100	4,0	4,0
KMR03208	100	5,0	5,0
KMR03103	125	5,5	5,0
KMR03209	125	6,0	6,0
KMR03104	150	8,0	7,0



### Offset Screwdrivers, DIN 5208

for cross recess screws, chrome vanadium steel, nickel plated

Art. No.	length (mm)	Ø shaft (mm)	version
KMR03401	100	6,0	PH1 + PH2
KMR03501	100	6,0	6,0 + PH2
KMR03402	150	8,0	PH3 + PH4



### Offset Screwdrivers, DIN 5208

for Pozidriv/Supadriv screws, chrome vanadium steel, nickel plated

Art. No.	length (mm)	Ø shaft (mm)	version
KMR04021	100	6,0	PZ1 + PZ2
KMR04022	150	8,0	PZ3 + PZ4



# Hexagon Key Wrenches - ergonomic T-Handle



## Hexagon Key Wrenches - ergonomic T-handle

blade chrome vanadium steel - nickel plated

Art. No.	Ø mm	length of blade (mm)	total length (mm)
220-220-02	2	200	225
220-252-02	2,5	200	225
220-315-02	3	150	175
220-320-02	3	200	225
220-415-02	4	150	175
220-420-02	4	200	225
220-515-02	5	150	182
220-520-02	5	200	232
220-615-02	6	150	182
220-620-02	6	200	232
220-720-02	7	200	232
220-815-02	8	150	182
220-820-02	8	200	232
220-102-02	10	200	239
220-122-02	12	200	239
220-143-02	14	300	339

Art. No.	Ø inch	length of blade (mm)	total length (mm)
220-564-52	5/64	100	125
220-332-52	3/32	100	125
220-180-52	1/8	150	175
220-532-52	5/32	150	175
220-316-52	3/16	150	182
220-140-52	1/4	150	182
220-516-52	5/16	150	182
220-380-52	3/8	200	239



## Hexagon Key Wrench Set - ergonomic T-handle with use of either end (2C)

blade chrome vanadium steel

Art. No.	Ø mm	length of blade (mm)	total length (mm)
226-020-07	2	125	151
226-025-07	2,5	125	151
226-030-07	3	125	151
226-040-07	4	125	151
226-050-07	5	150	184
226-060-07	6	150	184
226-080-07	8	175	218
226-100-07	10	175	218



# T-Line Wrenches

**T-Line**, hexagon wrench, ball point, chrome vanadium steel with multicomponent handle, with

Art. No.	size	PU
54720	SW 2.0 x 100	12
54721	SW 2.5 x 100	12
54722	SW 3.0 x 100	12
54723	SW 4.0 x 150	12
54724	SW 5.0 x 150	12
54725	SW 6.0 x 200	12
54726	SW 8.0 x 200	12
54727	SW 10.0 x 200	12

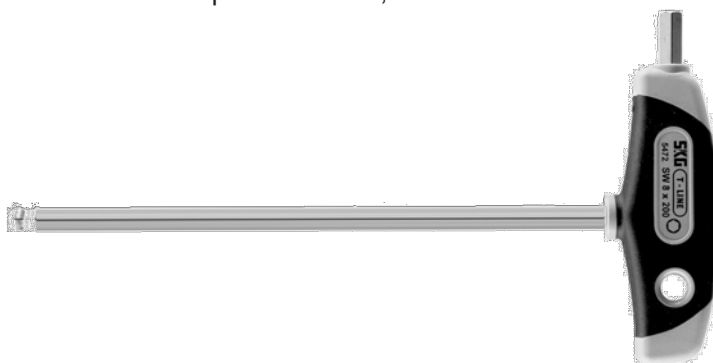

**T-Line**, hexagonal wrench, chrome vanadium steel with multicomponent handle, with side drive

Art. No.	size	PU
54730	SW 2.0 x 100	12
54731	SW 2.5 x 100	12
54732	SW 3.0 x 100	12
54733	SW 4.0 x 150	12
54734	SW 5.0 x 150	12
54735	SW 6.0 x 200	12
54736	SW 8.0 x 200	12
54737	SW 10.0 x 200	12

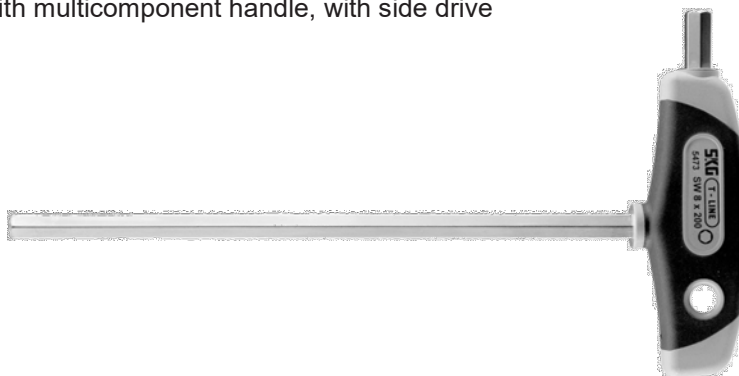

**T-Line**, torx wrench, chrome vanadium steel with multicomponent handle, with side drive

Art. No.	size	PU	Art. No.	size	PU
54960	T 9 x 100	12	54973	T 10 x 200	12
54961	T 10 x 100	12	54974	T 15 x 200	12
54962	T 15 x 100	12	54975	T 20 x 200	12
54963	T 20 x 100	12	54976	T 25 x 200	12
54964	T 25 x 100	12	54977	T 27 x 200	12
54965	T 27 x 150	12	54978	T 30 x 200	12
54966	T 30 x 150	12	54970	T 40 x 200	12
54967	T 40 x 150	12	54971	T 45 x 250	12
54968	T 45 x 150	12	54972	T 50 x 250	12
54969	T 50 x 150	12			



**T-Line**, socket wrench, chrome vanadium steel with multicomponent handle

Art. No.	size	PU	Art. No.	size	PU
54900	SW 5.5 x 125	12			
54901	SW 6.0 x 125	12			
54902	SW 7.0 x 125	12	54920	SW 7.0 x 350	12
54903	SW 8.0 x 125	12	54921	SW 8.0 x 350	12
54904	SW 9.0 x 125	12	54922	SW 9.0 x 350	12
54905	SW 10.0 x 125	12	54923	SW 10.0 x 350	12
54906	SW 11.0 x 125	12	54924	SW 11.0 x 350	12
54907	SW 12.0 x 125	12	54925	SW 12.0 x 350	12
54908	SW 13.0 x 125	12	54926	SW 13.0 x 350	12
54909	SW 14.0 x 125	12	54927	SW 14.0 x 350	12
54917	SW 17.0 x 125	12	54928	SW 17.0 x 350	12

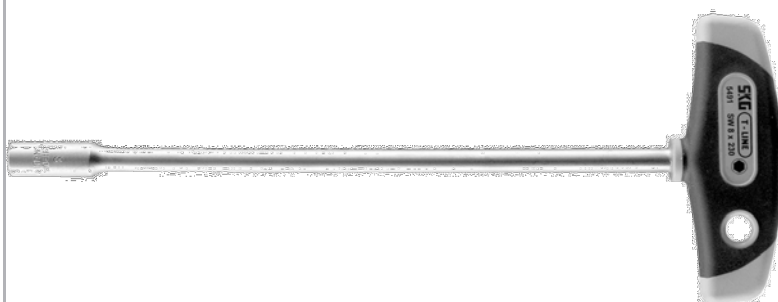

# Screwdrivers

## Screwdrivers Profi Comfort Line,

blade chrome plated, with black tip, multicomponent handle, blue/black, 12 pcs per carton

Art. No.	Art. No.	mm
	66450	2.5 x 75
66010	66451	3.0 x 75
	66060	3.0 x 250
66011	66452	4.0 x 100
	66063	4.5 x 250
66012		5.0 x 100
	66453	5.0 x 150
	66454	5.0 x 200
66013		5.5 x 125
	66064	5.5 x 300
66014		6.0 x 125
	66065	6.0 x 450
66015	66066	6.5 x 150
66016		7.0 x 150
66017		8.0 x 175
66018		10.0 x 200
66029		12.0 x 250
66030		14.0 x 250

**6601X**

**6645X/6606X**

## Screwdrivers Profi Comfort Line,

blade chrome plated, with black tip, multicomponent handle, blue/black, 12 pcs per carton

Art. No.	PH	mm
66350	0	60
66351	1	80
66352	2	100
66353	3	150
66047	4	200
33035	1	200
66036	1	300
66038	2	200
66039	2	300
66040	2	400
66046	3	300

**6635X**

Art. No.	PZ	mm
66370	0	60
66371	1	80
66372	2	100
66373	3	150
66057	4	200
66050	1	200
66051	1	300
66053	2	200
66054	2	300
66055	2	400
66056	3	300

**6637X**

# Screwdrivers

## Nutdrivers Profi Comfort Line,

blade chrome plated, multicomponent handle, blue/black, 12 pcs per carton

Art. No.	size	Art. No.	size
66930	3.0 x 125	66941	11.0 x 125
66931	3.5 x 125	66942	12.0 x 125
66932	4.0 x 125	66943	13.0 x 125
66933	4.5 x 125	66944	14.0 x 125
66934	5.0 x 125	66945	15.0 x 125
66935	5.5 x 125	66946	16.0 x 125
66936	6.0 x 125	66947	17.0 x 125
66937	7.0 x 125	66921	1/4" x 125
66938	8.0 x 125	66922	5/16" x 125
66939	9.0 x 125	66923	3/8" x 125
66940	10.0 x 125	66924	1/2" x 125



## Torx-Screwdrivers Profi Comfort Line,

blade chrome plated, with black tip, multicomponent handle, blue/black, 12 pcs per carton

Art. No.	size	Art. No.	size
66973	T 5 x 50	66956	T 20 x 100
66950	T 6 x 50	66957	T 25 x 100
66951	T 7 x 50	66958	T 27 x 100
66952	T 8 x 60	66959	T 30 x 115
66953	T 9 x 60	66960	T 40 x 130
66954	T 10 x 80	66961	T 45 x 130
66955	T 15 x 80	66962	T 50 x 150



## Ball Point Screwdrivers Profi Comfort Line,

blade chrome plated, with black tip, multicomponent handle, blue/black, 12 pcs per carton

Art. No.	size
66700	2.0 x 100
66701	2.5 x 100
66702	3.0 x 100
66703	4.0 x 100
66704	5.0 x 100
66705	6.0 x 125
66706	8.0 x 150
66707	10.0 x 150
66708	12.0 x 150





# Screwdrivers

## Screwdrivers Profi Basic-Line VDE

red insulated blade, with black tip, basic plastic handle, up to 1000V AC, GS approved, 12 pcs per carton

Art. No.	size
63600	PH 0 x 60
63601	PH 1 x 80
63602	PH 2 x 100
63603	PH 3 x 150
63604	PH 4 x 200



Art. No.	size
63800	PZ 0 x 60
63801	PZ 1 x 80
63802	PZ 2 x 100
63803	PZ 3 x 150
63804	PZ 4 x 200



Art. No.	size / mm
64700	2,5 x 75
64701	3,0 x 75
64702	3,0 x 100
64703	3,5 x 100
64704	4,0 x 100
64705	5,5 x 100
64706	6,5 x 100
64707	8,0 x 175
64708	10,0 x 200



## Screwdrivers Profi Comfort-Line VDE

red insulated blade, with black tip, multicomponent handle, red/yellow, up to 1000V AC, GS approved, 12 pcs per carton

Art. No.	size
66360	PH 0 x 60
66361	PH 1 x 80
66362	PH 2 x 100
66363	PH 3 x 150
66364	PH 4 x 200



Art. No.	size
66380	PZ 0 x 60
66381	PZ 1 x 80
66382	PZ 2 x 100
66383	PZ 3 x 150
66384	PZ 4 x 200



Art. No.	size
66470	2.5 x 75
66471	3.0 x 75
66472	3.0 x 100
66473	3.5 x 100
66474	4.0 x 100
66475	5.5 x 125
66476	6.5 x 150
66477	8.0 x 175
66478	10.0 x 200



# Screwdrivers

## Screwdrivers Profi Comfort-Line VDE

red insulated blade, with black tip, multicomponent handle, up to 1000V AC, GS approved, 12 pcs per carton

Art. No.	size	Art. No.	size
66982	T5 x 60	66989	T20 x 80
66983	T6 x 60	66990	T25 x 80
66984	T7 x 60	66991	T27 x 100
66985	T8 x 60	66992	T30 x 100
66986	T9 x 80	66993	T40 x 100
66987	T10 x 80	66994	T45 x 150
66988	T15 x 80		



## Socket Wrench Profi Comfort-Line VDE

red insulated blade, multicomponent handle, up to 1000V AC, GS approved, 12 pcs per carton

Art. No.	size	Art. No.	size
66900	4.0 x 125	66908	10.0 x 125
66901	4.5 x 125	66909	11.0 x 125
66902	5.0 x 125	66910	12.0 x 125
66903	5.5 x 125	66911	13.0 x 125
66904	6.0 x 125	66912	14.0 x 125
66905	7.0 x 125	66913	15.0 x 125
66906	8.0 x 125	66914	16.0 x 125
66907	9.0 x 125	66915	17.0 x 125



## SET Profi Comfort-Line VDE All in One - Display Set

use one screwdriver for six sizes, red insulated blade, with black tip, multicomponent handle, red/yellow insulated up to 1000V AC, GS approved, 36 pcs/box

**ALL-IN-ONE 1 SCREWDRIVER for 6 SIZES**



Art. No.	size
SET 01500	PH/PZ 1-2-3 (6 sizes)





# Screwdrivers

## Profi Comfort-Line VDE All in One

red insulated blade, with black tip, multicomponent handle, red/yellow insulated up to 1000V AC, GS approved, 12 pcs per carton

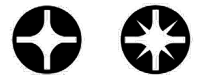

Art. No.	size
01500	PH/PZ 1-2-3



## Profi Silver-Line- All in One

chrome vanadium steel, multicomponent handle, with hex nut shank support, 12 pcs per carton

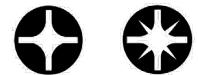

Art. No.	size
67150	PH/PZ 1-2-3



## Profi Comfort-Line VDE All in One in blisterpacking

red insulated blade, with black tip, multicomponent handle, red/yellow insulated up to 1000V AC, GS approved, 12 pcs per carton



Art. No.	size
01501	PH/PZ 1-2-3

## Profi Silver-Line- All in One in blisterpacking

chrome vanadium steel, multicomponent handle, with hex nut shank support, 12 pcs per carton



Art. No.	size
01502	PH/PZ 1-2-3

## Screwdriver Sets

### Profi Basic-Line Set - 6 pcs set

chrome plated blade, with black tip, basic plastic handle, black, 12 sets per carton

**Art. No. 56060**

- 4.0 x 75 mm
- 5.0 x 100 mm
- 6.0 x 125 mm
- 7.0 x 150 mm
- PH1 x 80 mm
- PH2 x 100 mm



**Art. No. 56070**

with hex nut shank support

- 4.0 x 75 mm
- 4.5 x 95 mm
- 5.5 x 100 mm
- 7.0 x 125 mm
- PH1 x 80 mm
- PH2 x 100 mm

### Profi Comfort-Line Set - 6 pcs set

chrome plated blade, with black tip,

**Art. No. 65602**

- 4.0 x 75 mm
- 5.0 x 100 mm
- 6.0 x 125 mm
- 7.0 x 150 mm
- PH1 x 80 mm
- PH2 x 100 mm



**Art. No. 56612**

with hex nut shank support

- 4.0 x 75 mm
- 4.5 x 95 mm
- 5.5 x 100 mm
- 7.0 x 125 mm
- PH1 x 80 mm
- PH2 x 100 mm

### Profi Basic-Line Set VDE - 7 pcs set

red insulated blade, with black tip, basic plastic handle, red, up to 1000V AC, 12 sets per carton

GS approved

**Art. No. 56080**

- 2.5 x 75 mm
- 4.0 x 100 mm
- 5.5 x 125 mm
- 6.5 x 150 mm
- PH1 x 80 mm
- PH2 x 100 mm
- voltage tester - 140 mm



### Profi Comfort-Line Set VDE - 7 pcs set

red insulated blade, with black tip, multicomponent red/yellow handle, up to 1000V AC, 12 sets per carton

GS approved

**Art. No. 65604**

- 2.5 x 75 mm
- 4.0 x 100 mm
- 5.5 x 125 mm
- 6.5 x 150 mm
- PH1 x 80 mm
- PH2 x 100 mm
- voltage tester - 140 mm



# Screwdriver Sets



## Profi Comfort-Line Set TORX-TR - 6 pcs.

blade chrome plated, with black tip, multicomponent handle, blue/black - tamper proof

Art. No. 65616



T10, T15, T20, T25, T27, T30



## Profi Comfort-Line Set TORX -TR - 7 pcs.

Art. No. 65615



T9, T10, T15, T20, T25, T27, T30



## Profi Comfort-Line Set TORX - 7 pcs.

blade chrome plated, with black tip, multicomponent handle, blue/black

Art. No. 65617



T10, T15, T20, T25, T27, T30, T40



## Profi Comfort-Line Set TORX - 8 pcs.

blade chrome plated, with black tip, multicomponent handle, blue/black

Art. No. 65613



T9, T10, T15, T20, T25, T27, T30, T40



# Screwdriver Sets

**KISTENMACHER brand Screwdriver VDE/GS set,**  
with one component handle, with red insulated blade  
- red PPC execution

**Art. No. 926/VDE**

**7 pcs set**

- 2.5 x 75 mm
- 4.0 x 100 mm
- 5.5 x 125 mm
- 6.5 x 150 mm
- PH1 x 80 mm
- PH2 x 100 mm
- voltage tester - 140 mm



**Art. No. 927/VDE**

**7 pcs set**

- 2.5 x 75 mm
- 3.5 x 100 mm
- 4.0 x 100 mm
- 5.5 x 125 mm
- PH1 x 80 mm
- PH2 x 100 mm
- voltage tester - 140 mm

**KISTENMACHER brand Screwdriver VDE/GS set,**  
with one component handle, with red insulated blade  
- red PPC execution

**Art. No. 926/VDE6**

**6 pcs set**

- 2.5 x 75 mm
- 4.0 x 100 mm
- 5.5 x 125 mm
- PH1 x 80 mm
- PH2 x 100 mm
- voltage tester - 140 mm



**Art. No. 926/VDE5**

**5 pcs set**

- 3.0 x 100 mm
- 3.5 x 100 mm
- 4.0 x 100 mm
- PH1 x 80 mm
- PH2 x 100 mm

**KISTENMACHER brand Screwdriver set,**

with one component handle, nickle plated blade,  
polished - red PPC execution

**Art. No. 925/WS**

**7 pcs set**

- 3.0 x 75 mm
- 4.0 x 100 mm
- 5.5 x 125 mm
- 7.0 x 150 mm
- PH0 x 60 mm
- PH1 x 80 mm
- PH2 x 100 mm





## Nutdriver & Bits



### KISTENMACHER brand Socket Wrench / Nut Driver

with nickel plated chrome vanadium blade and red transparent handle  
Type: „Optiform“



Art. No.	size (mm)
3790/3	3.0
3790/4	4.0
3790/4,5	4.5
3790/5	5
3790/5,5	5.5
3790/6	6
3790/7	7
3790/8	8

Art. No.	size (mm)
3790/9	9.0
3790/10	10.0
3790/11	11.0
3790/12	12.0
3790/13	13.0
3790/14	14.0
3790/17	17.0

Art. No.	size (inch)
3790/1/2	1/2
3790/3/8	3/8
3790/3/16	3/16
3790/7/32	7/32
3790/1/4	1/4
3790/5/32	5/32
3790/5/16	5/16
3790/1/8	1/8

### Philips (PH) Bit

C 6,3 - 1/4" Hexagon,  
high quality chrome vanadium steel



Art. No.	size (mm)	length (mm)
142201025	1	25
142201050	1	50
142201070	1	70
142201090	1	90
142202025	2	25
142202050	2	50
142202070	2	70
142202090	2	90
142203025	3	25
142203050	3	50
142203070	3	70
142203090	3	90
142204032	4	32

### Pozidriv (PZ) Bit

C 6,3 - 1/4" Hexagon,  
high quality chrome vanadium steel



Art. No.	size (mm)	length (mm)
142301025	1	25
142301050	1	50
142301070	1	70
142301090	1	90
142302025	2	25
142302050	2	50
142302070	2	70
142302090	2	90
142303025	3	25
142303050	3	50
142303070	3	70
142303090	3	90
142304032	4	32

### TORX (TX) Bit

C 6,3 - 1/4" Hexagon,  
high quality chrome vanadium steel



Art. No.	size (mm)	length (mm)
1445/WU/5/10	5	25
1445/WU/6/10	6	25
1445/WU/7/10	7	25
1445/WU/8/10	8	25
1445/WU/9/10	9	25
1445/WU/10/10	10	25
1445/WU/15/10	15	25
1445/WU/20/10	20	25
1445/WU/25/10	25	25
1445/WU/27/10	27	25
1445/WU/30/10	30	25
1445/WU/40/10	40	25
1445/WU/45/10	50	25
1445/WU/55/10	55	25

### Slotted Bit

C 6,3 - 1/4" Hexagon  
high quality chrome vanadium steel



Art. No.	size (mm)	length (mm)
142103025	3.0	25
142103525	3.5	25
142104025	4.0	25
142105525	5.5	25
142106525	6.5	25
142108025	8.0	25



## Screwdriver Bits

### Profi Double-sided Screwdriver Bit

high quality chrome vanadium steel - 1/4"

Philips (PH) on both sides - 65 mm



packing options	qty
in plastic box	10/12
in plastic box	50/60
in sales carton	100/120
bulk packing	500/2500/5000

### Profi Double-sided Screwdriver Bit

high quality chrome vanadium steel - 1/4"

Philips (PH) and Slotted Screws - 60 mm



packing options	qty
in plastic box	10/12
in plastic box	50/60
in sales carton	100/120
bulk packing	500/2500/5000

### Profi Double-sided Screwdriver Bit

high quality chrome vanadium steel - 1/4"

Pozidriv (PZ) on both sides - 65 mm

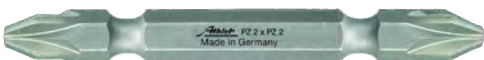

packing options	qty
in plastic box	10/12
in plastic box	50/60
in sales carton	100/120
bulk packing	500/2500/5000

### Profi Double-sided Screwdriver Bit

high quality chrome vanadium steel - 1/4"

Pozidriv (PZ) and Slotted Screws - 60 mm

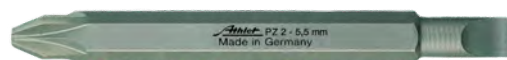

packing options	qty
in plastic box	10/12
in plastic box	50/60
in sales carton	100/120
bulk packing	500/2500/5000

Many other versions available upon request. Please contact our sales staff for further information!

### Profi Long Screwdriver Bit

high quality chrome vanadium steel - 1/4"

Phillips (PH) DIN 3126 - E 6,3



Art. No.	size (mm)	length (mm)	packing options	qty
14320150	1	50	in plastic box	10/12
14320170	1	70	in plastic box	50/60
14320189	1	89	in sales carton	100/120
14320250	2	50	bulk packing	500/2500/5000
14320270	2	70		
14320289	2	89		
14320350	3	50		
14320370	3	70		
14320389	3	89		

### Profi Long Screwdriver Bit

high quality chrome vanadium steel - 1/4"

Slotted DIN 3126 - E 6,3



Art. No.	size (mm)	size (mm)	length (mm)	packing options	qty
1431053050	0,5	3,0	50	in plastic box	10/12
1431053070	0,5	3,0	70	in plastic box	50/60
1431063550	0,6	3,5	50	in sales carton	100/120
1431084550	0,8	4,5	50	bulk packing	500/2500/5000
1431105550	1,0	5,5	50		0
1431126550	1,2	6,5	50		
1431168050	1,6	8,0	50		

Many other versions available upon request. Please contact our sales staff for further information!



## Screwdriver Bits

### Profi long Screwdriver Bit

high quality chrome vanadium steel  
TORX (TX) - 1/4" Drive DIN 3126 - E 6,3 - 50 m

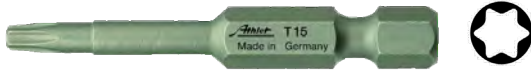

packing options	qty
in plastic box	10/12
in plastic box	50/60
in sales carton	100/120
bulk packing	500/2500/5000

### Profi long Screwdriver Bit

high quality chrome vanadium steel  
Hexagonal - 1/4" Drive DIN 3126 - E 6,3 - 50 mm



packing options	qty
in plastic box	10/12
in plastic box	50/60
in sales carton	100/120
bulk packing	500/2500/5000

### Double Sided Screwdriver Bit

high quality chrome vanadium steel - 1/4"  
red metallic laquered, packing in transparent plastic box  
available in various colours



Art. No.	size	colour	packing
141202065-R/12	PH2 + PH2 65 mm	red metallic	12/box
141202065-R/20	PH2 + PH2 65 mm	red metallic	20/box



### Magnetic Bit holder DIN 3126

with strong permanent magnet, with stainless steel sleeve  
packed in plastic box



Art. No.	size	st. steel sleeve	circlip
14300054100/50	50 mm E 6.3	10,0 x 25 mm	w/o
14300104100/50	100 mm E 6.3	10,0 x 35 mm	w/o
14300104200/50	100 mm E 6.3	11,1 x 35 mm	with
14300154100/50	150 mm E 6.3	10,0 x 35 mm	w/o
14300154200/50	150 mm E 6.3	11,1 x 35 mm	with

Many other versions available upon request. Please contact our sales staff for further information!

## Chisels & Punches



### Flat Chisels DIN 6453

chrome-vanadium steel, oval shank

Art. No.	size (mm)	slitting width (mm)
312-100	100 x 14 x 9	15
312-125	125 x 14 x 9	15
312-150	150 x 17 x 11	18
312-175	175 x 20 x 12	21
312-200	200 x 23 x 13	24
312-250	250 x 23 x 13	25
312-300	300 x 23 x 13	26
312-400	400 x 26 x 13	32



### Stone Chisels DIN 7254 B

chrome-vanadium steel, oval shank

Art. No.	size (mm)	slitting width (mm)
310-20-200	200 x 20 x 12	25
310-20-250	250 x 20 x 12	25
310-23-300	300 x 23 x 13	28
310-23-350	350 x 23 x 13	28
310-23-400	400 x 23 x 13	28
310-26-500	500 x 26 x 13	31
310-26-600	600 x 26 x 13	31
310-26-800	800 x 26 x 13	33



### Mason's Chisels DIN 7254 A

chrome-vanadium steel, octagonal shank

Art. No.	size (mm)	slitting width (mm)
311-100	100 x 10 x 12	12
311-125	125 x 10 x 12	12
311-150	150 x 12 x 16	16
311-200	200 x 16 x 19	19
311-250	250 x 16 x 23	23
311-300	300 x 18 x 26	26
311-350	350 x 18 x 26	26
311-400	400 x 18 x 26	26
311-500	500 x 20 x 30	30



### Pointed Chisels DIN 7256

chrome-vanadium steel, octagonal shank

Art. No.	size (mm)
308-200	200 x 16
308-250	250 x 16
308-300	300 x 18
308-350	350 x 18
308-400	400 x 18
308-500	500 x 20





## Arch Punches & Sets



### Arch/Wad Punches

according to DIN 7200 A, drop forged, blue lacquered oven finish, channel polished



Art. No.	size (mm)	Art. No.	size (mm)	Art. No.	size (mm)	Art. No.	size (mm)	Art. No.	size (mm)	Art. No.	size (mm)
0100010	1	0100060	6	0100150	15	0100250	25	0100350	35	0100450	45
0100015	1,5	0100065	6,5	0100160	16	0100260	26	0100360	36	0100460	46
0100020	2	0100070	7	0100170	17	0100270	27	0100370	37	0100470	47
0100025	2,5	0100080	8	0100180	18	0100280	28	0100380	38	0100480	48
0100030	3	0100090	9	0100190	19	0100290	29	0100390	39	0100490	49
0100035	3,5	0100100	10	0100200	20	0100300	30	0100400	40	0100500	50
0100040	4	0100110	11	0100210	21	0100310	31	0100410	41		
0100045	4,5	0100120	12	0100220	22	0100320	32	0100420	42		
0100050	5	0100130	13	0100230	23	0100330	33	0100430	43		
0100055	5,5	0100140	14	0100240	24	0100340	34	0100440	44		

other sizes available on request

### Arch Punch Sets

plain, blue lacquered oven finish, with polished channel, according to DIN 7200 A, in roll-up pouch

#### Available Sets:

Art. No.	pcs per set	sizes (mm)
0122930	6	2-4-6-8-10-12
0120810	8	3-6-8-10-12-16-20-25
0120310	8	3-5-7-8-10-13-16-19
0120410	9	3-5-7-8-10-13-16-19-22
0120510	10	3-5-7-8-10-13-16-19-22-25
0120660	12	3-5-6-8-10-12-13-14-16-20-22-25



other sets with different sizes are available on request

### Belt Punches

according to DIN 7200 B  
plain, blue lacquered oven finish, with fine polished nose

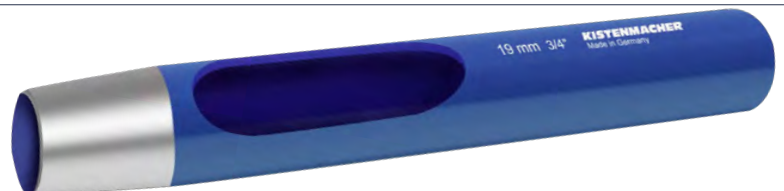

Art. No.	mm	inch	Art. No.	mm	inch	Art. No.	mm	inch	Art. No.	mm	inch
0200010	1	1/32	0200050	5	3/16	0200110	11	7/16	0200190	19	3/4
0200015	1,5		0200055	5,5		0200120	12	15/32	0200200	20	25/32
0200020	2	1/16	0200060	6	7/32	0200130	13	1/2	0200210	21	13/16
0200025	2,5		0200065	6,5		0200140	14	9/16	0200220	22	7/8
0200030	3	1/8	0200070	7	1/4	0200150	15	19/32	0200230	23	29/32
0200035	3,5		0200080	8	5/16	0200160	16	5/8	0200240	24	15/16
0200040	4	5/32	0200090	9	11/32	0200170	17	21/32	0200250	25	1
0200045	4,5		0200100	10	3/8	0200180	18	11/16			

## Chisels & Punches

### Belt Punch Sets

plain, blue lacquered oven finish, with fine polished nose, according to DIN 7200B,

in roll-up pouch

Art. No.	pcs per set	sizes (mm)
0220022/B	7	3-5-7-8-10-11-13
0220032/B	8	3-5-7-8-10-13-16-19
0220012/B	9	2-3-4-5-6-7-8-9-10
0220042/B	9	3-5-7-8-10-13-16-19-22
0220052/B	10	3-5-7-8-10-13-16-19-22-25



### Center Punches

chrome vanadium steel, octagon shank, polished point, lacquered oven finish, available with blue (B) or golden brown lacquered shank

Art. No.	Art. No.	size (mm)
105-100x8/B	105-8	100 x 8
105-10/B	105-10	100 x 10
105-12/B	105-120	120 x 10
105-150x16/B	105-12	120 x 12
105-180x16/B	105-150	150 x 12

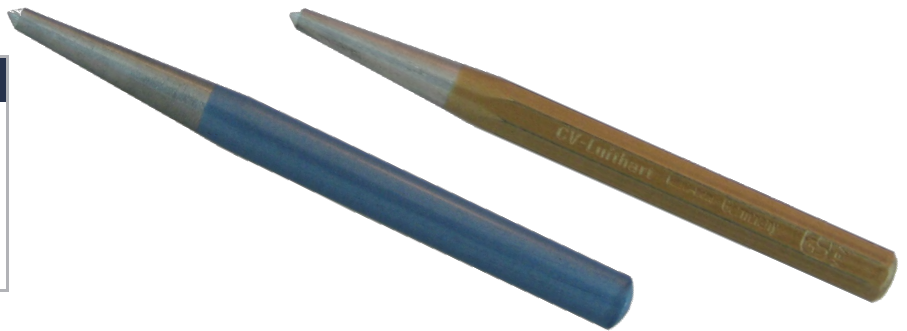

### Brad Punches

chrome vanadium steel, octagon shank, lacquered oven finish

Art. No.	size (mm)	point (mm)	Art. No.	size (mm)	point (mm)
100-1	120 x 10	1	100-7	120 x 12	7
100-2	120 x 10	2	100-8	120 x 12	8
100-3	120 x 10	3	100-9	150 x 12	9
100-4	120 x 10	4	100-10	150 x 12	10
100-5	120 x 10	5	100-12	150 x 14	12
100-6	120 x 12	6	100-16	175 x 18	16



### Parallel Pin Punches

chrome vanadium steel, octagon shank, lacquered oven finish

Art. No.	size (mm)	point (mm)	Art. No.	size (mm)	point (mm)
110-2	150 x 10	2	110-9	150 x 12	9
110-2,5	150 x 10	2,5	110-10	150 x 12	10
110-3	150 x 10	3	110-12	150 x 14	12
110-4	150 x 10	4	110-14	175 x 16	14
110-5	150 x 10	5	110-16	200 x 18	16
110-6	150 x 10	6	110-18	200 x 20	18
110-7	150 x 12	7	110-20	250 x 22	20
110-8	150 x 12	8			

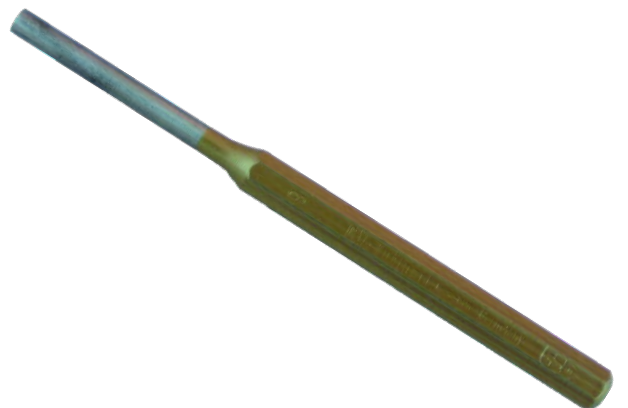

other sizes/set combinations are available on request

## Chisels & Punches

### Tool Sets

6 pieces set, made of chrome vanadium self-hardening steel

consisting of:

flat chisels:

- 125 x 10 x 12 mm
- 150 x 12 x 16 mm

centre punch:

- 150 x 12 mm

brad punches:

- 120 x 10 x 2 mm
- 120 x 10 x 3 mm
- 120 x 10 x 4 mm



Art. No. **225** - in PVC wallet

### Pin Punch Sets

6 pieces set, octagonal chrome vanadium self-hardening steel, with non spread head, acc. to DIN 6450 C, lacquered oven finish

consisting of:

pin punches:

- 3 mm
- 4 mm
- 5 mm
- 6 mm
- 7 mm
- 8 mm



Art. No. **290** - in PVC wallet

### Tool Sets

6 pieces set, made of chrome vanadium self-hardening steel

consisting of:

flat chisels:

- 125 x 10 x 12 mm
- 150 x 12 x 16 mm

centre punch:

- 150 x 12 mm

brad punches:

- 120 x 10 x 2 mm
- 120 x 10 x 3 mm
- 120 x 10 x 4 mm



Art. No.: **210** - in PVC case

### Pin Punch Sets

6 pieces set, octagonal chrome vanadium self-hardening steel, with non spread head, acc. to DIN 6450 C, lacquered oven finish

consisting of:

pin punches:

- 3 mm
- 4 mm
- 5 mm
- 6 mm
- 7 mm
- 8 mm



Art. No.: **265** - in PVC case

### Brad and Centre Punch Sets

6 pieces set, made of chrome vanadium steel, plain, polished point, lacquered oven finish

consisting of:

brad punches:

- 120 x 10 x 2, 3, 4, 5, 6 mm

centre punch:

- 120 x 12 mm



Art. No.: **235** - in PVC case

### Pin Punch Sets

6 pieces set, octagonal chrome vanadium steel, acc. to DIN 6450 C, consisting of 3, 4, 5, 6, 7, 8 mm



Art. No.: **270**  
in metal box



Art. No.: **280**  
in PVC box

## Number & Letter Punches

### Sets of Figure Punches A-Z

27 pcs sets in blue plastic box, pointed (with sight edge), according to DIN 1451

Art. No.	size (mm)	Art. No.	size (mm)
10101000	1	10108000	8
10102000	2	10109000	9
10103000	3	10110000	10
10104000	4	10111000	11
10105000	5	10112000	12
10106000	6	10114000	14
10107000	7	10115000	15



### Sets of Number Punches 0-9

9 pcs sets in blue plastic box, pointed (with sight edge), according to DIN 1451

Art. No.	size (mm)	Art. No.	size (mm)
10001000	1	10008000	8
10002000	2	10009000	9
10003000	3	10010000	10
10004000	4	10011000	11
10005000	5	10012000	12
10006000	6	10014000	14
10007000	7	10015000	15



Art. No.	size (mm)	execution	Art. No.	size (mm)	execution
2010	10	A-Z - 27 pcs	2080	80	A-Z - 27 pcs
2015	15	A-Z - 27 pcs	2090	90	A-Z - 27 pcs
2020	20	A-Z - 27 pcs	2100	100	A-Z - 27 pcs
2025	25	A-Z - 27 pcs	2120	120	A-Z - 27 pcs
2030	30	A-Z - 27 pcs	2150	150	A-Z - 27 pcs
2035	35	A-Z - 27 pcs	2180	180	A-Z - 27 pcs
2040	40	A-Z - 27 pcs	2200	200	A-Z - 27 pcs
2050	50	A-Z - 27 pcs	2250	250	A-Z - 27 pcs
2060	60	A-Z - 27 pcs	2300	300	A-Z - 27 pcs
2070	70	A-Z - 27 pcs			

Art. No.	size (mm)	execution	Art. No.	size (mm)	execution
3010	10	0-9 - 9 pcs	3080	80	0-9 - 9 pcs
3015	15	0-9 - 9 pcs	3090	90	0-9 - 9 pcs
3020	20	0-9 - 9 pcs	3100	100	0-9 - 9 pcs
3025	25	0-9 - 9 pcs	3120	120	0-9 - 9 pcs
3030	30	0-9 - 9 pcs	3150	150	0-9 - 9 pcs
3035	35	0-9 - 9 pcs	3180	180	0-9 - 9 pcs
3040	40	0-9 - 9 pcs	3200	200	0-9 - 9 pcs
3050	50	0-9 - 9 pcs	3250	250	0-9 - 9 pcs
3060	60	0-9 - 9 pcs	3300	300	0-9 - 9 pcs
3070	70	0-9 - 9 pcs			

### Sets of Figure and Number Stencils A-Z

- made of zinc plate  
- according to DIN 1451



### Signograph 25 Sets

a powerful engraver with interchangeable hardened stylus and hard metal stylus

- especially suitable for hard metals and for all soft metals, plastic etc.

Art. No. **1500743** with 1,8 mtr. cable and BS plug (13A)  
Art. No. **1500740** with 1,8 mtr. cable and Schuko plug (16A)



## Sealing Compound

### CORTECO brand Universal Sealing Compound EVO300

colour: anthracite grey  
 paste type: 100% silicone,  
 temperature resistance up to +300° C,  
 in display cartons of 25 pieces

For automotive and industrial applications. Wherever resistance required to oil leaks and temperatures in engines with steel or cast iron case (sumps, cylinder heads, oil pumps, differentials etc.)

Easily adapts to uneven or irregular surfaces. Good resistance to coolants and chemical agents.



Art. No.	content	carton unit	pallet unit
49372187	70 ml	25 pcs	2.250 pcs

### CROLDINO HAND-CLEANING PASTE

cleans thoroughly and protects skin from oil, grease and lubricants. Bio-degradable and clinically tested. Contains special hand care components. Ideal for workshop, home use and industrial.

Art. No.	content
01 000310	500 ml



### DURSOL® SHINE

cleaning and care products for all objects made of aluminium, chrome, steel, brass, copper, tin, etc. In one operation the surface is cleaned, preserved and a tarnishing is delayed. Achieves brilliant high gloss.

Art. No.	content
01 001188	75 ml



### AUTOSOL® METAL POLISH

world-famous and internationally awarded cleaning and care product for all metallic surfaces. Contamination and rust can be easily removed in a single operation. Due to the balanced formulation of the active ingredients, surface protection is applied to the metals in addition to excellent cleaning. Achieves brilliant high gloss.

Art. No.	content
01 001000	75 ml



### AUTOSOL® STAINLESS STEEL POLISH

specially developed for cleaning and polishing stainless steel. Leaves a radiant high gloss without scratching the surface.

Art. No.	content
01 001734	75 ml



### AUTOSOL® GOLD & SILVER POLISH

ideal care product for surfaces made of gold, silver and other precious metals. The surfaces are cleaned and conserved in one operation. Effectively delays the tarnishing of silver. Achieves a radiant high gloss.

Art. No.	content
01 001050	75 ml



## Funnels

### Funnel Sets

polyethylene, oil, acid and fuel-resistant,  
colour: orange

Art. No.	pcs per	Ø (mm)
02 360	4	50, 75, 100, 120
02 360 954	5	50, 75, 100, 120, 150
02 372 043 with brass strainer	6	50, 75, 100, 120, 150, 160



### Funnels

polyethylene, with black flexible removable  
discharge spout (330 mm), oil, acid and  
fuel-resistant  
colour: orange

Art. No.	Ø (mm)	height (mm)
02 665	150	490



### Funnels

tin plated, oil and diesel resistant, available with straight  
spout or flexible metal spout (with removable brass  
strainer)



Art. No.	Ø (mm)	height (mm)	version
02 342	160	220	straight
02 344	200	280	straight
02 645	160	220	flex. spout 300 mm
02 344 950	200	280	flex. spout 300 mm

### Funnels

polyethylene, with flexible discharge  
spout (330 mm), oil, acid and  
fuel-resistant, with safe handle  
colour: orange



Art. No.	Ø (mm)	height (mm)	version
02 662	160	470	
02 674	160	470	with brass strainer

### Funnels

polyethylene, straight spout, with ventilation tube  
oil, acid and fuel-resistant  
colour: orange



Art. No.	Ø (mm)	brass strainer	height (mm)
02 361	50		80
02 362	75		110
02 363	100		130
02 364	120		160
02 365	150		180
02 366	200		220
02 366 017	200	X	220
02 367	250		255
02 367 020	250	X	255

### Combi Funnels

polyethylene, with angled safety  
spout (200 mm) and removable  
brass strainer  
colour: orange

Art. No.	Ø (mm)	height (mm)
02 562	160	260



### Funnels

polyethylene, with flexible removable metal discharge  
spout (300 mm) with tread connection and  
removable brass strainer  
colour: orange



Art. No.	Ø (mm)	height (mm)
02 675	160	330



## Funnels & Oilers

### PRESSOL

#### Funnels

polyethylene, straight spout,  
oil, petrol and acid resistant  
with removable brass strainer  
colour: orange



Art. No.	Ø (mm)	height (mm)
02 372	160	205

#### Flexible Discharge Spouts

metal  
suitable for funnels:  
02 342, 02 344, 02344 950  
02645



Art. No.	length (mm)
02 640	300

#### Flexible Discharge Spout

polyethylene  
suitable for funnels:  
02 372, 02 662, 02 674  
colour: orange



Art. No.	length (mm)
00 238	320

#### Oil Bottle Funnels

polyethylene  
oil, acid and fuel-resistant  
colour: orange



Art. No.	Ø (mm)	height (mm)
02 671	120	160

#### Oilers

polyethylene container with sealing clip  
colour: white-transparent

Art. No.	cap (ml)	height (mm)
06 068	60	120
06 064	125	175
06 065	250	200
06 066	500	245



#### Funnels

polypropylene, straight spout  
oil, acid and fuel-resistant  
foodstuff-compatible  
colour: white-transparent



Art. No.	Ø (mm)	height (mm)
02 369	350	435

#### Oilers

polyethylene container  
and brass spout  
colour: white-transparent

Art. No.	cap (ml)	height (mm)
06 863	50	130
06 864	125	160
06 865	250	185
06 866	500	230



#### Industrial Oilers Metal Container

single-acting brass pump  
with rigid aluminium (135 mm) and  
superflex spout (210 mm)  
colour: blue

Art. No.	cap (ml)	height (mm)
05 223	250	110
05 224	350	120
05 225	500	150
05 226	750	200



## Oilers

### Standard Oilers - Metal Container

single-acting plastic pump,  
with rigid aluminium or superflex spout  
colour: red



Art. No.	cap (ml)	height (mm)	spout	spout length (mm)
05 111	125	110	rigid	105
05 121	125	110	superflex	150
05 112	175	130	rigid	105
05 122	175	130	superflex	150
05 113	250	110	rigid	135
05 133	250	110	superflex	210
05 114	350	120	rigid	135
05 134	350	120	superflex	210
05 115	500	150	rigid	135
05 135	500	150	superflex	210



### Standard Oilers - Polyethylene Container

single-acting plastic pump,  
with rigid spout or with superflex spout  
colour: white-transparent

Art. No.	cap (ml)	height (mm)	spout	spout length (mm)
05 118	350	135	rigid	135
05 138	350	135	superflex	210
05 119	500	150	rigid	135
05 135	500	150	superflex	210



### DIY Oilers - Polyethylene Container

single-acting plastic pump and aluminium spout  
colour: white-transparent

Art. No.	cap (ml)	height (mm)	spout length (mm)
04 111	150	215	105



### Industrial Oilers

single-acting brass pump with gravity controlled  
suction tube and aluminium spout

Art. No.	cap (ml)	height (mm)	colour	spout length (mm)
03 802	200	270	metallic grey	135
04 802	200	270	white	135
03 803	300	320	metallic grey	165
04 803	300	320	white	165
03 805	500	350	metallic grey	165
04 085	500	350	white	165



**03 80...**  
zinc die cast container



**04 80...**  
polyethylene container

## Measures & Cans

### PRESSOL

#### Measuring Jugs

polypropylene  
with scale  
oil and acid resistant  
foodstuff-compatible  
stackable  
colour: transparent



Art. No.	cap (liter)	height (mm)
07 060	0.25	120
07 061	0.5	135
07 062	1.0	170
07 063	2.0	215
07 064	3.0	240
07 065	5.0	270

#### Measuring Cylinders

polypropylene  
with scale, break-proof  
safe dispensing  
colour: transparent



Art. No.	cap (liter)	height (mm)
07 160	0.025	170
07 161	0.05	200
07 162	0.10	255
07 163	0.25	310
07 164	0.5	345
07 165	1.0	415

#### Measuring Jugs

polyethylene  
with scale  
oil, acid and fuel-resistant  
foodstuff-compatible  
colour: white-transparent



Art. No.	cap (liter)	height (mm)
07 500	0.5	190
07 501	1.0	230
07 502	2.0	290
07 503	3.0	335
07 505	5.0	380

#### Flexible Discharge Spouts

polyethylene  
length: 160 mm **with sealing ring**  
colour: white-transparent  
suitable for:  
07 500, 07 501, 07 502



Art. No. **00 328 950**

polyethylene  
length: 330 mm  
colour: white-transparent  
suitable for:  
07 503, 07 505



Art. No. **00 238 820**

#### Measuring Jugs

tin plated  
with polyethylene safety spout  
ergonomic handle



Art. No.	cap (liter)	height (mm)
07 341	0.5	230
07 342	1.0	270
07 343	2.0	320

#### Measuring Jugs

tin plate  
with flexible metal spout  
ergonomic handle



Art. No.	cap (liter)	height (mm)
07 642	1.0	370
07 643	2.0	410

## Grease Guns



### One Hand Grease Guns

one hand operated

- Ø piston 8 mm
- connection: M 10 x 1
- wall thickness of tube: 1.0 mm
- loading grease cartridge 400 g
- L-design handle
- lacquering: silver
- capacity 500 ccm
- single carton box packing

Art. No. **12 250**

with straight spout (150 mm)



### One Hand Grease Guns

one hand operated

- Ø piston 8 mm
- connection: G 1/8"
- wall thickness of tube: 1.0 mm
- loading grease cartridge 400g
- L-design handle
- lacquering: silver
- capacity 500 ccm
- single carton box packing

Art. No. **12 270**

with straight spout (150 mm)



### Compressed Air Grease Guns

with hydraulic coupler with 4 jaws

- Ø piston 6 mm
- connection: M 10 x 1
- wall thickness of tube 1.0 mm
- pressure ratio: 50:1
- loading grease cartridge 400 g
- L-design handle
- lacquering: silver
- capacity 500 ccm
- single carton box packing

Art. No. **18 071**

with angled spout (150 mm)



### Compressed Air Grease Gun

with precision machined coupler with 4 jaws

- Ø piston 6 mm
- connection: M 10 x 1
- wall thickness of tube 1.0 mm
- pressure ratio: 50:1
- loading grease cartridge 400 g
- L-design handle
- lacquering: silver
- capacity 500 ccm
- single carton box packing

Art. No. **18 072**

with high pressure hose  
(11 x 300 mm)



## Grease Guns



### Grease Gun, Standard

manually lever operated  
with hydraulic coupler, with 4 jaws

- Ø piston 8 mm
- connection M 10 x 1
- wall thickness of tube 1 mm
- loading grease cartridge 400 g
- L-design handle
- lacquering: silver
- capacity 500 ccm



Art. No. **12 632 (12 632 980)**

with angled spout (150 mm)  
packed in polybag

Art. No. **12 634**

with angled spout (150 mm)  
packed in carton packing

Art. No. **12 630 (12 630 980)**

with high pressure hose (8 x 300 mm)  
packed in polybag

Art. No. **12 633**

with high pressure hose (8 x 300 mm)  
packed in carton packing



### Industrial Grease Gun

manually lever operated  
with precision machined coupler with 4 jaws

- Ø piston 9 mm
- connection M 10 x 1
- wall thickness of tube 1.5 mm
- variable stroke system
- loading grease cartridge 400g
- T-design handle
- lacquering: graphite-grey
- capacity 500 ccm
- filling valve

Art. No. **12 675**

with angled spout (150 mm)



### Industrial Grease Gun "Elite"

body made of galvanized steel

- Ø piston 9 mm
- M 10 x 1 filling nipple
- wall thickness of tube 1.0 mm
- variable stroke system
- loading grease cartridge 500 g
- T-design handle
- lacquering: galvanized
- capacity 750 ccm
- display carton packing

Art. No. **12 678**

with retention adapter



### Grease Nipple Assortments

various sizes, packed in transparent  
sales box

Art. No.	pcs per set
16 092	70
16 090	140
16 099	387



**16 092**



**16 090**



**16 099**

## Grease Gun Accessoires



### Button Head Couplers

flat design, M 10 x 1 - female  
for button head grease nipples,  
slide on type, M- and T-nipples



Art. No.	connection
12 061	16 mm

### Button Head Couplers

flat design, M 10 x 1 - female  
for button head grease nipples,  
M- and T-nipples



Art. No.	connection
12 060	10 mm
12 062	16 mm

### Button Head Couplers

flat design, M 10 x 1 - female  
for button head grease nipples,  
M- and T-nipples



Art. No.	connection
12 063	22 mm

### Angled Connectors

for button head grease nipples,  
steel galvanized - 90° angle

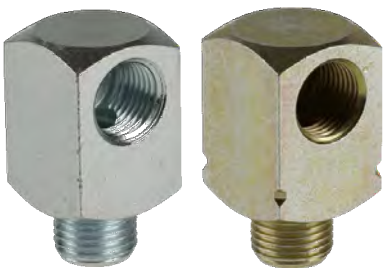

Art. No.	connection
12 035	M 10x1 - male
12 035 805	G 1/8" - male

### Bayonet Couplers

for all bayonet type grease nipples,  
galvanized, 14 mm  
size: 20 x 41 mm



Art. No.	connection
12 013	M 10x1 - female
12 023	G 1/8" - female

### Quick Release Adapters

for hydraulic coupler,  
steel galvanized, 12 mm  
size: 18 x 31 mm



Art. No.	connection
12 006	M 10x1 - female
12 006 125	G 1/8" - female

### Hydraulic Couplers

with 4 jaws, Ø 15 mm for H-nipples,  
made of galvanized steel



Art. No.	connection
12 631 980	M 10x1 -female
12 731 980	G 1/8" - female

### Precision Machined Couplers

with 4 jaws, turned, Ø 15 mm for H-nipples,  
made of galvanized steel



Art. No.	connection
12 643 980	M 10x1 - female
12 743 980	G 1/8" - female



## Push Type Guns



### Oil Suction Guns

steel body - single action,  
with flexible transparent hose 350 mm,  
with PVC cover, colour: blue



Art. No	ml
12 902	500

### Oil Suction Guns

polished brass body, single action,  
with angled brass spout 135 mm  
with zinc end caps, colour: gold



Art. No	ml
12 935	500

### Oil Suction Guns

galvanized steel body, single action,  
with flexible transparent hose 350 mm,  
with zinc end caps



Art. No	ml
12 907	500
12 908	1000

### High Pressure Grease Hoses DIN 1283

reinforcement: polyester, high-strength  
burst pressure: 900 bar

Art. No	Art. No	size (mm)
M 10 x 1 male	G 1/8" male	
12 656	12 756	8 x 300
12 666	12 766	8 x 500
12 655	12 755	11 x 300
12 665	12 765	11 x 500



### High Pressure Grease Hoses DIN 1283 with Coupler

reinforcement: polyester, high-strength  
burst pressure: 900 bar

Art. No	Art. No.	size (mm)
M 10 x 1 male	G 1/8" male	
12 656 810	12 756 810	8 x 300
12 666 810	12 766 810	8 x 500
12 655 809	12 755 809	11 x 300
12 665 809	12 765 809	11 x 500

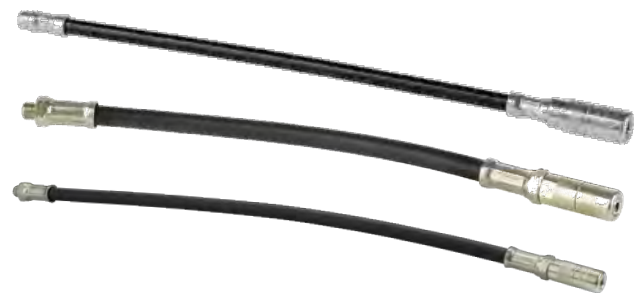

### Push Type Guns for Grease

galvanized steel casing,  
for hydraulic and ball type grease nipples  
pressure 60 to 80 bar

Art. No	ml
12 362	80
12 363	150
12 365	300



### Push Type Guns for Grease

plastic casing, pressure 20 bar  
with pointed coupler, funnel type or  
with universal coupler, ball type

Art. No	Art. No	ml
pointed coupler	universal coupler	
12 321	12 331	65
12 322	12 332	150



# Grease Nipples

## Type H1 - DIN 71 412

straight, 180°, hexagon version  
- galvanized or stainless steel

Art. No. galvanized	size	SW (mm)	A (mm)	B (mm)	C (mm)
15 000	1/4" BSF	7	15	5.5	
15 007	M 6 x 1	7	15	5.5	
15 009	M 8 x 1	9	15	5.5	
15 010	M 8 x 1,25	9	15	5.5	
15 013	M 10 x 1	11	15	5.5	
15 014	M 10 x 1,25	11	15	5.5	
15 015	M 10 x 1,5	11	15	5.5	
15 026	1/8" NPT	11	15	5.5	
15 037	G 1/8"	11	15	5.5	
15 071	F 6 x 1 SFG	7	15	5.5	
15 027	G 1/4" NPT	14	19	8	
15 038	G 1/4"	14	16	6.5	

Art. No. stainless st.	size	SW (mm)	A (mm)	B (mm)	C (mm)
15 907	M 6 x 1	7	15	5.5	
15 909	M 8 x 1	9	15	5.5	
15 913	M 10 x 1	11	15	5.5	
15 926	1/8" NPT	11	15	5.5	
15 937	G 1/8"	11	15	5.5	
15 938	R 1/4"	14	17.5	6.5	

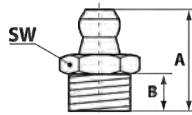

## Type H2 SK - DIN 71 412

hexagon version - 45°  
angled, galvanized

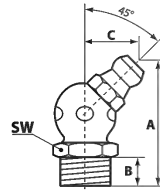

Art. No.	size	SW (mm)	A (mm)	B (mm)	C (mm)
15 100 140	1/4" BSF	9	23.5	5.5	10.5
15 107 140	M 6 x 1	9	23.5	5.5	10.5
15 108	M 7 x 1	10	23.5	5.5	10.5
15 109 140	M 8 x 1	9	23.5	5.5	10.5
15 110 140	M 8 x 1,25	9	23.5	5.5	10.5
15 113 140	M 10 x 1	11	25	5.5	11.5
15 115 140	M 10 x 1,5	11	25	5.5	11.5

## Type H2 VK - DIN 71 412

square version - 45°  
angled, galvanized

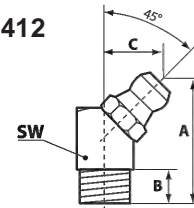

Art. No.	size	SW (mm)	A (mm)	B (mm)	C (mm)
15 172	F 8 x 1 SFG	9	20.5	5.5	10.5
15 173	F 10 x 1 SFG	11	20.5	5.5	11
15 100	1/4" BSF	9	23.5	5.5	10.5
15 107	M 6 x 1	9	23.5	5.5	10.5
15 109	M 8 x 1	9	20.2	5.5	10.5
15 110	M 8 x 1,25	9	20.2	5.5	10.5
15 113	M 10 x 1	11	20.5	5.5	11.5
15 115	M 10 x 1,5	11	20.5	5.5	11.5
15 137	G 1/8"	11	20.5	5.5	11.5

## M1 Button Head Grease Nipples - DIN 3404

hexagon version, galvanized

Art. No.	size	SW (mm)	A (mm)	B (mm)	C (mm)
57 807	M 6 x 1	17	17	6	16
57 809	M 8 x 1	17	17	6	16
57 810	M 8 x 1,25	17	17	6	16
57 813	M 10 x 1	17	17	6	16
57 815	M 10 x 1,5	17	17	6	16
57 817	M 12 x 1,5	17	17	6	16
57 837	G 1/8"	17	17	6	16
57 838	G 1/4"	17	17	6	16

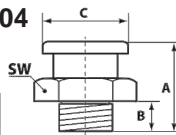

round head



Art. No.	size	SW (mm)	A (mm)	B (mm)	C (mm)
55 807	M 6 x 1	15	16	6	16.5
55 809	M 8 x 1	15	16	6	16.5
55 810	M 8 x 1,25	15	16	6	16.5
55 813	M 10 x 1	15	16	6	16.5
55 815	M 10 x 1,5	15	16	6	16.5
55 837	G 1/8"	15	16	6	16.5
55 838	G 1/4"	15	16	6	16.5

hex. head



## Type H3 VK - DIN 71 412

square version - 90°  
angled, galvanized

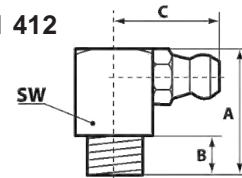

Art. No.	size	SW (mm)	A (mm)	B (mm)	C (mm)
15 200	1/4" BSF	9	18	5.5	14
15 207	M 6 x 1	9	18	5.5	14
15 209	M 8 x 1	9	18	5.5	14
15 210	M 8 x 1,25	9	18	5.5	14
15 213	M 10 x 1	11	18	5.5	15
15 215	M 10 x 1,5	11	18	5.5	15
15 237	G 1/8"	11	18	5.5	15



## Manual Pumps & Jerry Cans

### Steel Barrel Pumps, Manual Operation

suitable for 60 l, 200 l and 220 l containers,  
suction tube length: 480 - 900 mm,  
steel discharge spout,  
galvanized steel components



Art. No. 13 012



Art. No. 13 012 954



Art. No. 13 016

Art. No. **13 012** - without accessories  
delivery rate/stroke 16 l/min.  
steel discharge spout

Art. No. **13 012 954** - with accessories/ gear  
oil installation kit (1,5 m hose)  
delivery rate/stroke 16 l/min.  
with anti-drip nozzle

Art. No. **13 016** - without accessories  
delivery rate/stroke 10 l/min.  
plastic discharge spout

### Rotary Pumps

suitable for 60 l, 200 l containers,  
suction tube length: 980 mm, steel discharge spout,  
delivery rate/stroke 25 l/min.

Art. No. **13 055** - without accessories

Art. No. **13 056** - with accessories  
complete with discharge hose 2 m length,  
hose clips, anti-kink spring



Art. No. 13 055



Art. No. 13 056

### Jerrycans - Steel

suitable for liquid fuels  
made of pickled sheet steel 0.8 mm  
small neck dia. 30 mm, colour olive-green  
other colours available upon request  
packing. 70 pcs/pallet  
manufactured and tested to comply with  
German DIN/TÜV/GS and American AS 2906 standard

- without inside coating
- optionally available with inside coating



Art. No	capacity (liter)	height (mm)
CAN 5 L	5	275
CAN 10 L	10	390
CAN 20 L	20	470

### Fuel Cans

high density polyethylene  
with flexible spout - cover cap  
suitable for liquid fuels  
UN-approval  
colour: red



Art. No	capacity (liter)	height (mm)
21 131	5	237
21 133	10	319
21 137	20	410

## Manual Pumps / Waste Oil Disposals



### Manually Operated GREASE Lubrication Systems

manually lever operated  
 discharge pressure: up to 550 bar  
 burst pressure: 850 bar  
 suitable for 20 kg container, Ø 270-310 mm  
 dust cover (17 176)  
 stabilising-fixing bracket (17 300)  
 one hand operated grease gun  
 connection M 10 x 1 (17 600)  
 spout, straight, M 10 x 1, 150 mm (12 435)  
 coupler, 4 jaws, M 10 1 (12 631)  
 discharge hose, 1,5 m (17 003)  
 suction tube length 510 mm



Art. No. **17 620**

### Oil Dispenser Units

14 kg container  
 container size 220 x 380 mm  
 manually operated  
 delivery rate/stroke 85 cm<sup>3</sup>  
 complete set with all accessories  
 and foot rest  
 colour: grey satin RAL 7040



Art. No. **17 790 mobile**  
 with 2 fixed wheels

### Grease Dispenser Units

16 kg container  
 container size 220 x 380 mm  
 manually operated  
 deliveryrate/stroke: 10 cm<sup>3</sup>  
 discharge pressure 25 bar  
 complete set with all accessories and foot rest  
 standard colour: grey satin RAL 7040

Art. No. **17 791**

**portable**  
 with foot rest

Art. No. **17 792**

**mobile**  
 with 2 fixed wheels



### Waste Oil Drainers

mobile, air pressured oil evacuation,  
 Ø drain bowl 420 mm - volume: 18 l  
 telescopic height level: 1180 - 1750 mm,  
 male quick release adapter G1/4", NW 7.2  
 for rectus coupling  
 transparent discharge hose - 2 m  
 2 fixed rear wheels, 2 front castor wheels  
 standard body lacquering: grey satin RAL 7040  
 bowl: blue RAL 5010

Art. No. **27 070**

75 l



## Waste Oil Disposals and Oil, Grease & Water supplies

### Waste Oil Suction Units

#### VENTURI System

mobile, 2 airline connections  
 recommended air pressure: 6 bar  
 male quick release adapter G1/4, NW 7.2,  
 for rectus coupling  
 with suction hose 2 m with spiral spring  
 lever ball valve with suction probe adapters  
 for: VW/Audi, Mercedes, BMW, Smart

2 fixed rear wheels, 2 front castor wheels,  
 standard body lacquering: grey satin RAL 7040

Art. No. **27 622** 75 l

Art. No. **27 632** 75 l

with visual inspection reservoir 7 l



### Waste Oil Drainers-/Suction Units

#### VENTURI System

mobile, 2 airline connections, Ø drain bowl 420 mm,  
 telescopic height level: 1180 - 1750 mm  
 male quick release adapter G 1/4, NW 7.2,  
 for rectus coupling  
 with transparent discharge hose  
 lever ball valve with suction probe adapters  
 for: VW/Audi, Mercedes, BMW, Smart

2 fixed rear wheels, 2 front castor wheels,  
 standard body lacquering: grey satin RAL 7040

Art. No. **27 622 680** 75 l

Art. No. **27 632 680** 75 l

with visual inspection reservoir 7 l



### Hose Reels for Oil - Grease and Water/Air supply

Wall/Floor mounting versions  
 open or encased hose reels

Art. No. open	Art. No. encased	hose reel	bar	DN	connection threads	hose length
29 142	29 172	oil	120	12	G 1/2" male and female	10 m
29 143	29 173	oil	120	12	G 1/2" male and female	15 m
29 242	29 272	grease	400	6	G 1/4 " male and female	10 m
29 243	29 273	grease	400	6	G 1/4 " male and female	15 m
29 442	29 472	water/air	20	10	G 3/8" male and female	10 m
29 443	29 473	water/air	20	10	G 3/8" male and female	15 m
29 542	29 572	cooling agent	120	12	G 1/2" male and female	10 m
29 543	29 573	cooling agent	120	12	G 1/2" male and female	15 m



## Grease / Fresh Oil Supplies



### Pneumatic Grease Supply Systems 50:1

high performance, dust cover, follower plate and adjustable stabilising fixing-bracket, high-pressure grease control gun, 360 degree Z-swivel connector, high-pressure grease hose 2 m, pressure reduction valve (8 bar pre-set) male quick release airline connector

#### mobile - to suit 20 kg container

with trolley  
 Ø 270-310 mm, with 2 m grease hose

Art. No. **18 417 051**

#### mobile - to suit 50 kg container

with trolley  
 Ø 335-385 mm, with 4 m grease hose

Art. No. **18 766 391**

#### stationary - to suit 20 kg container

Ø 270-310 mm with 2 m grease hose

Art. No. **18 419 051**

#### stationary - to suit 200 kg container

Ø 540-590 mm

Art. No. **18 785 051** with 4 m grease hose  
 Art. No. **18 785 056** with 6 m grease hose



#### mobile - to suit 200 kg container

with trolley  
 Ø 540-590 mm

Art. No. **18 786 051** with 4 m grease hose  
 Art. No. **18 786 056** with 6 m grease hose



### Pneumatic Grease Supply Systems 50:1

high performance - suction tube  
 dust cover, follower plate and adjustable stabilising-fixing bracket  
 pressure reduction valve (8 bar pre-set)  
 airline connection: G 1/4"

#### to suit 20 kg container

Ø 270-310 mm suction pipe 600 mm  
 Art. No. **18 740 051**

#### to suit 25 - 60 kg container

Ø 335-385 mm suction pipe 700 mm  
 Art. No. **18 760 051**

#### to suit 200 kg container

Ø 540-590 mm suction pipe 1000 mm  
 Art. No. **18 780 051**



## Grease / Fresh Oil Supplies

### Pneumatic Grease Pumps 50:1



recommended air pressure: 8 bar (min. 2 bar/ max. 10 bar)  
 cylinder capacity engine 220 cm<sup>3</sup>, cylinder capacity pump 8 cm<sup>3</sup>  
 quantity of strokes at 8 bar at a free-flow: 220 min.  
 pump capacity at 8 bar at a free-flow: 1100 g/min.  
 pump pressure at 8 bar air pressure: 400 bar  
 air consumption at 8 bar air pressure: 400 l/min.  
 airline connection: G 1/4"



suction tube length:

- Art. No. **18 711 051** 600 mm, to suit 20-30 kg container
- Art. No. **18 713 051** 700 mm, to suit 25-60 kg container
- Art. No. **18 716 051** 1000 mm, to suit 200 kg container

### Pneumatic Oil and Diesel Pumps 1:1

fresh oil supply  
 60 l / min  
 pressure side: G 3/4" male  
 metal container connection: G 2" male  
 airline connection: G 1/4" female  
 suction tube length 860 mm G 1" male  
 to suit 200 l/220 l metal container  
 max. length of discharge hose 10 m



Art. No. **19 135**

### Pneumatic Oil and Diesel Pumps 3:1

fresh oil supply  
 20 l / min  
 pressure side: G 1/2" male  
 metal container connection: G 2" male  
 airline connection: G 1/4" female  
 suction tube length 860 mm G 3/4" male  
 to suit 200 l/220 l metal container  
 max. length of discharge hose 10 m



Art. No. **19 235**

### High Pressure Grease Control Guns

with hydraulic 4-claw coupler  
 angled spout

- Art. No. **18 104** G 1/8" female
- Art. No. **18 114** G 1/4" female



### Rotary Swivel Connectors

connection G 1/8" male, G 1/4" female  
 finish: yellow galvanized steel

- Art. No. **18 082** Z-swivel connector 3 x 360°
- Art. No. **18 083** swivel connector 2 x 360°



### Oil Control Valves

swivel connection G 1/2" female, galvanized steel spout  
 operating pressure: 70 bar, automatic anti-drip nozzle  
 manual switch-off

Art. No. **19 718**



## Fuel Oil / Diesel Supplies

### PREMAxx Dieselpumpsets



not selfpriming with 4 m discharge hose and 1.6 m suction hose  
with on-off switch and motor-thermal-protection  
hose connection: G 1" female, for 200 l containers and tanks  
suction height: 2,5 m - discharge height: 15 m  
drum connection: G 2" male

Art. No.	l/min.	v/hz	control gun	with...
23 731	52	230/50	standard	2 pin plug
23 737	52	230/50	automatic shut-off	2 pin plug
23 731 932	52	230/50	standard	13A BS plug
23 737 932	52	230/50	automatic shut-off	13A BS plug
23 721	43	24	standard	tapping clamps
23 727	43	24	automatic shut-off	tapping clamps
23 711	38	12	standard	tapping clamps
23 717	38	12	automatic shut-off	tapping clamps



### MOBIFlxx Dieselpumpsets

selfpriming with 4 m discharge hose and 1.6 m suction hose  
with on-off switch and 3 m electric connection cable  
vane pump with integral bypass  
max. suction height: 3m  
hose connection: G 1" female

Art. No.	l/min.	v	control gun	with...
23 015	35	12	standard nozzle	battery clips
23 006	35	12	automatic shut-off nozzle	battery clips
23 015 824	35	24	standard nozzle	battery clips
23 006 824	35	24	automatic shut-off nozzle	battery clips



### Air Maintenance Units

complete with pressure regulator, manometer,  
moisture separator and in-line lubricator, recommended  
for use with pneumatic oil and grease pumps  
connection: G 1/4" male, max. operating pressure 10 bar  
with male quick release coupler  
and wall mounting bracket

Art. No. **20 218 950**



## Regulators & Filters

### Regulators

with wall screw clamp, pressure adjusting range 0 -12 bar, blue colour, with pressure gauge thread



Art. No.	thread (inch)
AT-R18	1/8"
AT-R14	1/4"
AT-R12	3/8"-1/2"
AT-R34	3/4"
AT-R1	1"

### Lubricators

suitable for filtered air, with wall screw clamp, blue colour

**A)** 12 bar with transparent cup    **B)** 18 bar with metal cup



Art. No.	thread (inch)
AT-L18	1/8"
AT-L14	1/4"
AT-L12	3/8"-1/2"

Art. No.	thread (inch)
AT-LM18	1/8"
AT-LM14	1/4"
AT-LM12	3/8"-1/2"
AT-LM34	3/4"
AT-LM1	1"

### Filter Regulators

with wall screw clamp, blue colour, with pressure gauge thread

**A)** pressure adjusting range 0-12 bar with transparent cup

**B)** pressure adjusting range 0-18 bar with metal cup



### Filters

with wall screw clamp, blue colour

**A)** pressure adjusting range 0-12 bar with transparent cup

**B)** pressure adjusting range 0-18 bar with metal cup



Art. No.	thread (inch)
AT-F18	1/8"
AT-F14	1/4"
AT-F12	3/8"-1/2"

Art. No.	thread (inch)
AT-FM18	1/8"
AT-FM14	1/4"
AT-FM12	3/8"-1/2"
AT-FM34	3/4"
AT-FM1	1"

Art. No.	thread (inch)
AT-FR18	1/8"
AT-FR14	1/4"
AT-FR12	3/8"-1/2"

Art. No.	thread (inch)
AT-FRM18	1/8"
AT-FRM14	1/4"
AT-FRM12	3/8"-1/2"
AT-FRM34	3/4"
AT-FRM1	1"

## Regulators & Filters & Car Washing Guns



### Filter Regulators + Lubricators

with wall screw clamp, blue colour

**A)** pressure adjusting range 0-12 bar  
with transparent cup

**B)** pressure adjusting range 0-18 bar  
with metal cup



### Filters + Regulators + Lubricators

with wall screw clamp, blue colour

**A)** pressure adjusting range 0-12 bar  
with transparent cup

**B)** pressure adjusting range 0-18 bar  
with metal cup



Art. No.	thread
AT-FR+L18	1/8"
AT-FR+L14	1/4"
AT-FR+L12	3/8"-1/2"

Art. No.	thread (inch)
AT-FR+LM18	1/8"
AT-FR+LM14	1/4"
AT-FR+LM12	3/8"-1/2"
AT-FR+LM34	3/4"
AT-FR+LM1	1"

Art. No.	thread (inch)
AT-F+R+L18	1/8"
AT-F+R+L14	1/4"
AT-F+R+L12	3/8"-1/2"

Art. No.	thread (inch)
AT-F+R+LM18	1/8"
AT-F+R+LM14	1/4"
AT-F+R+LM12	3/8"-1/2"
AT-F+R+LM34	3/4"
AT-F+R+LM1	1"

### Pressure Filter Regulators

with lower connection (inf.) or rear connection (post.)  
two adjustable air outlets with gauge Ø 50 mm  
aluminium body



Art. No. bayonet coupler	Art. No. universal coupler	connection (inch)
R10-INF.3/8"	R10UNI-INF.3/8"	lower conn. 3/8"
R14-INF.1/2"	R14UNI-INF.1/2"	lower conn. 1/2"
R10-POST.1/4"	R10UNI-POST.1/4"	rear conn. 1/4"
R14-POST.3/8"	R14UNI-POST.3/8"	rear conn. 3/8"

### Car Washing Guns

made of brass - connection to 1/2" hose, max. 40 bar - +90°C  
possible version:

1 mounted nozzle  
and 1 spare nozzle



Art. No.	fitted nozzle	spare nozzle
160.04/2+4	2 mm	4 mm
160.04/2	2 mm	2 mm
160.04/3	3 mm	3 mm
160.04/4	4 mm	4 mm
160.007	2 mm	w.o. nozzle
160.009	4 mm	w.o. nozzle
160.00	w.o. nozzle	w.o. socket



# Paint Spray & Washing Guns



## Paint Spray Guns

packing in coloured single display box

with gravity cup  
 tank capacity 500 ccm  
 nylon cover, needle 1.5 mm  
 operating pressure 4-8 bar

Art. No. **162A**



with suction cup  
 tank capacity 1000 ccm  
 aluminium cover, needle 1.5 mm  
 operating pressure 4-8 bar

Art. No. **162C**



with suction cup  
 tank capacity 1000 ccm  
 PVC cover, needle 1.5 mm  
 operating pressure 4-8 bar

Art. No. **701420**



## Paint Spray Guns

packing in coloured single display box  
 with suction cup - tank capacity 1000 ccm  
 with bayonet closing, aluminium cover,  
 needle 1.5 mm  
 operating pressure 4-8 bar

Art. No. **162DS**



## Washing Guns

packing: 2 pcs/carton

GR 1000-tank and cover  
 made from aluminium

Art. No. **61A**



GR 1000-M30  
 red steel tank

Art. No. **61B**



connection possible with DIN 7,2  
 connector or bayonet coupling 1/4"

# Blow Guns & Tyre Inflating Guns



## Blow Off Guns - Aluminium

in bulk packing  
air flow 6 bar

Art. No.: **60A**



## Blow Off Guns - Aluminium

in bulk packing  
air flow 6 bar  
with long tube

Art. No.: **60B**

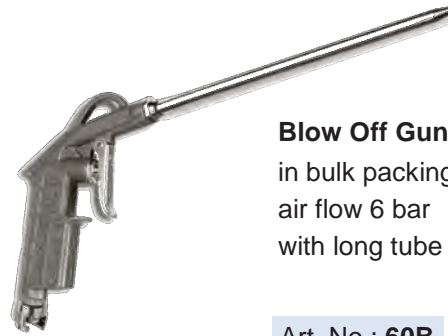

## Tyre Inflating Guns

manometer with pressure gauge Ø 63 mm  
(marked with „Made in Italy“),  
max. pressure 12 bar

Art. No. **60D** 40 cm pipe



## Digital Tyre Pressure Gauges

manometer Ø 63 mm  
(marked with „Made in Italy“),  
max. pressure 12 bar

Art. No. **60DD** 50 cm pipe



## Universal Head - Brass

clip-on connectors

Art. No.	Ø (mm)	for hose in. Ø
60E/06	6	5 mm
60E/08	8	7 mm

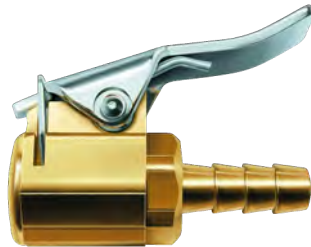

## Tyre Control Pressure Gauge

with pressure gauge Ø 63 mm  
(marked with „Made in Italy“),  
0-12 bar, with 40 cm tube with  
chuck for direct attachment to  
the valve

Art. No. **60F**



## Clip-on ball Foot Air Chucks

self-closing after detaching  
from tyre valve (closed end)

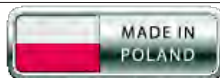

Art. No.	Ø (mm)	hose Ø (mm)
14.4151	8	7
14.4171	9	8



## Clip-on ball Foot Air Chucks

with female thread  
self-closing after detaching  
from tyre valve (closed end)

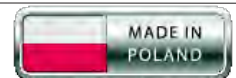

Art. No.	Ø (inch)
14.5451	1/4" - 18NPT
14.5851	1/8" - 27NPT



## Service Station Tyre Inflating Chucks

Art. No.	Ø	for hose
14.6602	8	7 mm
14.6805	9	8 mm



## Truck head with handgrip

Art. No.	Ø	for hose
60E2/06	6	5 mm
60E2/08	8	7 mm



## Blow Guns and Quick Couplings

### Blow Gun - Plastic

robust polyamide, low weight, perfect for electronic devices, nozzle 1,5 mm



### Blow Gun - Aluminium die cast

the classic blowgun, housing made of die-casting, nozzle 1,5 mm



### Blow Gun - forged Aluminium

forged (very robust) aluminium, clear anodized, nozzle 1,5 mm



Art. No.	connection	nozzle	Art. No.	connection	nozzle	Art. No.	connection	nozzle
EGKBGP-S	DN 7,2	short	EGKBGD-S	DN 7,2	short	EGKBGF-S	DN 7,2	short
EGKBGP-L	DN 7,2	long	EGKBGD-L	DN 7,2	long	EGKBGF-L	DN 7,2	long

### Standard Quick-Disconnect Couplings DN 7,2

universal quick-disconnect couplings made of brass blank, new stem profile for safe fit of the hose and assembly

#### Couplings with male thread

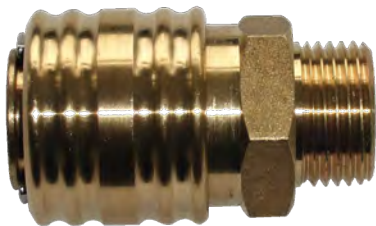

#### Couplings with female thread

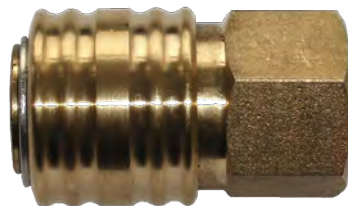

#### Couplings with hose stem

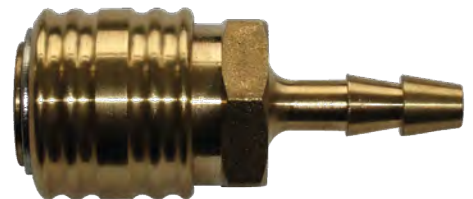

Art. No.	thread
EGKS 18 A	G 1/8"
EGKS 14 A	G 1/4"
EGKS 38 A	G 3/8"
EGKS 12 A	G 1/2"
EGKS 1415 A	M 14 x 1,5
EGKS 1615 A	M 16 x 1,5
EGKS 1815 A	M 18 x 1,5

Art. No.	thread
EGKS 18 I	G 1/8"
EGKS 14 I	G 1/4"
EGKS 38 I	G 3/8"
EGKS 12 I	G 1/2"
EGKS 1415 I	M 14 x 1,5
EGKS 1615 I	M 16 x 1,5
EGKS 1815 I	M 18 x 1,5

Art. No.	hose $\varnothing$ (mm)
EGKS 6 T	6 mm
EGKS 8 T	8 mm
EGKS 9 T	9 mm
EGKS 10 T	10 mm
EGKS 13 T	13 mm

## Quick Couplings

### Standard Quick-Disconnect Couplings DN 7,2

universal quick-disconnect couplings made of brass blank, new stem profile for safe fit of the hose and assembly

#### Plugs with male thread



Art. No.	thread
EGKS 18 NA	G 1/8"
EGKS 14 NA	G 1/4"
EGKS 38 NA	G 3/8"
EGKS 12 NA	G 1/2"

#### Plugs with female thread



Art. No.	thread
EGKS 18 NI	G 1/8"
EGKS 14 NI	G 1/4"
EGKS 38 NI	G 3/8"
EGKS 12 NI	G 1/2"

#### Plugs with hose stem



Art. No.	thread
EGKS 6 S	6 mm
EGKS 8 S	8 mm
EGKS 9 S	9 mm
EGKS 10 S	10 mm
EGKS 13 S	13 mm

### Distributors for Quick-Disconnect Couplings DN 7,2

assembled of brass MS 58, for compressed air distribution on central places

#### 3-Way-Distributors



Art. No.	inlet G female (inch)
EGKTW 38 ES	G 3/8"
EGKTW 12 ES	G 1/2"

#### 4-Way-Distributors



Art. No.	inlet G female (inch)
EGKFW 38 ES	G 3/8"
EGKFW 12 ES	G 1/2"

Art. No.	thread G (inch)
185.029	1/8"-1/8"
185.030	1/8"-1/4"
185.033	1/4"-1/4"
185.053	1/4"-3/8"
185.054	1/4"-1/2"
185.055	3/8"-3/8"
185.075	3/8"-1/2"
185.077	1/2"-1/2"
185.078	1/2"-3/4"
185.013	3/4"-3/4"
185.015	3/4"-1"
185.014	1"-1"
280-228	1 1/2"-1 1/2"
454-9	2"-2"

#### Pneumatic Double Nipples

with male thread



Art. No.	female - male thread G (inch)
1117	1/4"-1/8"
322-18	3/8"-1/8"
1068	3/8"-1/4"
1191	1/2"-1/4"
1018	1/2"-3/8"
1292	3/4"-1/2"
1193	1"-3/4"
409-81	1 1/2"-3/4"
417-50	2"- 1 1/4"
417-45	2"-1 1/2"

#### Pneumatic Reducing Nipples

with female thread, male thread and hexagon



## Quick Couplings

### Pneumatic-Connectors DIN 3852-2

made of brass, with male thread parallel and inner cone 45°



Art. No.	thread G (inch)	length (mm)	hose $\varnothing$ (mm)
113-51	1/8"	37	6
113-52	1/8"	37	9
113-31a	1/4"	40	6
113-40a	1/4"	40	9
113-71	1/4"	45	13
113-32a	3/8"	43	6
113-34a	3/8"	43	9
113-43	3/8"	48	13
113-67	1/2"	44	6
113-66	1/2"	44	9
113-44	1/2"	49	13
113-25	3/4"	49	9
113-26	3/4"	54	13
113-27	3/4"	58	19
113-28	1"	60	19
113-29	1"	66	25

### Pneumatic Hose Connectors DIN 8542

made of brass



Art. No.	hose $\varnothing$ (mm) 1	hose $\varnothing$ (mm) 2	length (mm)
113.00	4	4	64
113.01	6	6	72
113.02	6	8	72
113.03	9	9	72
113.04	13	13	72

### Hose Stem for Hexagon Nuts with ball seal

made of brass



Art. No.	thread G (inch)	length (mm)	hose $\varnothing$ (mm)
295-5	1/8"	25	4
295-6	1/8"	25	6
113-49	1/4"	34,5	4
106-16	1/4"	37	6
113-50	1/4"	37	9
120-10a	3/8"	47,5	4
113-38	3/8"	39	6
113-39	3/8"	39	9
113-47	1/2"	41	6
113-48	1/2"	41	9
113-45	1/2"	54	13

### Pneumatic-Connectors

made of brass

#### Hexagon Nuts



Art. No.	thread G (inch)	SW
295-7	1/8"	12
124-19	1/4"	17
120-9	3/8"	19
124-18	3/8" LH	19
147-12	1/2"	24

## Quick Couplings

### Hose Clamps DIN 20039 A

robust clamps of malleable iron, zinc plated and yellow passivated with two parts with loose saddles



Art. No.	for hose $\varnothing$ (inch = mm)	hose outer range
SL 29	1/2" = 13 mm	22-29
SL 30	3/4" = 19 mm	28-34
SL 31	1" = 25 mm	32-40
SL 32	1.1/4" = 32 mm	39-49
SL 33	1.1/2" = 38 mm	48-60
SL 34	2" = 50 mm	56-72
SL 35	2.1/2" = 63 mm	77-94
SL 36	3" = 75 mm	89-101
SL 37	3" = 75 mm	94-115
SL 38	3.1/2" = 89 mm	113-127
SL 39	3.1/2" = 89 mm	115-145
SL 40	4" = 100 mm	127-140
SL 41	4" = 100 mm	135-155
SL 42	5" = 125 mm	155-175
SL 43	6" = 150 mm	175-195
SL 44	7" = 175 mm	210-225
SL 45	8" = 200 mm	227-250

### Claw Couplings

robust couplings of malleable iron, zinc plated and yellow passivated

#### Hose (formerly DIN 3483)

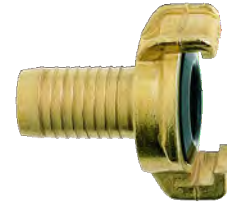

Art. No.	for hose $\varnothing$ (inch = mm)
SKG 6	1/4" = 6 mm
SKG 10	3/8" = 10 mm
SKG 13	1/2" = 13 mm
SKG 15	5/8" = 15 mm
SKG 19	3/4" = 19 mm
SKG 25	1" = 25 mm
SKG 32	1.1/4" = 32 mm

#### Female (formerly DIN 3482)

Art. No.	thread G (inch)
KIG 14	1/4"
KIG 38	3/8"
KIG 12	1/2"
KIG 34	3/4"
KIG 10	1"
KIG 54	1.1/4"



### Original Rubber Ring

made of perbunan, oil resistant



Art. No 516-6

#### Male (formerly DIN 3481)

Art. No.	thread G (inch)
KAG 14	1/4"
KAG 38	3/8"
KAG 12	1/2"
KAG 34	3/4"
KAG 10	1"
KAG 54	1.1/4"



## Water & Air Hose Reels

### Water Hose Reels WS 32

light, practical and mobile water hose extension, special hose with textile inlay and spiral wound cross-weave, with a spraying nozzle with waterstop and a top connector, drum made of special highly breakproof plastic, strong carrying frame made of galvanized tubular steel  
hose length 20m, Ø 1/2"

Art. No. **1237120**



### Compressor Hose Reels

with high-quality fabric hose, oil-resistant, up to 15 bar of pressure, complete with quick release couplings, drum made of special highly breakproof plastic

#### A) standard

Art. No. **1127020**

frame made of steel tubing with bright galvanized zinc coating, hose length 20m, Ø 6 x 12 mm



#### B) anti twist

Art. No. **1127030**

with axial connection permitting rolling up or out during operation, throughflow system, with connection hose, suitable for wall mounting, frame made of steel tubing with bright galvanized zinc coating, hose length 20m, Ø 9 x 15 mm

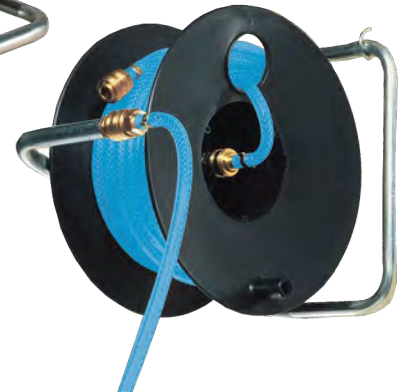

### Automatik-Box Air ABA 10 D

- 10 m + 2 m highly flexible hose made of polyurethan, suitable for air or cold water
- hose Ø 8/12 mm for max. working pressure 12 bar
- with comfortable automatic reeling with ratchet hose release
- 1/4" connections

Art. No. **1240320300**



## Pressure Gauges



### Pressure Gauges

plastic frame, with snap in window made of macrolon, steel casing enamelled black with 2 readings bar / psi, bottom connection

Type 50.11

Type 63.11

Type 80.18

Type 100.18



### Pressure Gauges

with chrome plated ring, steel casing enamelled black with 2 readings bar / psi, bottom connection

Type 63.14

Type 80.11

Type 100.11

Type 160.11



Nominal size Ø mm connection		50 1/4 NPT	63 1/4 NPT	80 1/2 NPT	100 1/2 NPT
pressure range Bar / PSI		No. 50.11-...	No. 63.11-...	No. 80.18-...	No. 100.18-...
0-1	0-15	1B	1B	1B	1B
0-1.6	0-25	1.6B	1.6B	1.6B	1.6B
0-2.5	0-30	2.5B	2.5B	2.5B	2.5B
0-4	0-60	4B	4B	4B	4B
0-6.8	0-100	6.8B	6.8B	6.8B	6.8B
0-10.5	0-150	10.5B	10.5B	10.5B	10.5B
0-13.5	0-200	13.5B	13.5B	13.5B	13.5B
0-17	0-250	17B	17B	17B	17B
0-21	0-300	21B	21B	21B	21B
0-24	0-350	24B	24B	24B	24B
0-27.5	0-400	27.5B	27.5B	27.5B	27.5B
0-41	0-600	41B	41B	41B	41B
0-54	0-800	54B	54B	54B	54B
0-68	0-1000	68B	68B	68B	68B
0-100	0-1500	100B	100B	100B	100B
0-140	0-2000	140B	140B	140B	140B
0-170	0-2500	170B	170B	170B	170B
0-200	0-3000	200B	200B	200B	200B
0-250	0-3500	250B	250B	250B	250B
0-315	0-4000	315B	315B	315B	315B
0-400	0-6000	400B	400B	400B	400B

Nominal size Ø mm connection		63 1/4 NPT	80 1/2 NPT	100 1/2 NPT	160 1/2 NPT
pressure range Bar / PSI		No. 63.14-...	No. 80.11-...	No. 100.11-...	No. 160.11-...
0-1	0-15	1B	1B	1B	1B
0-1.6	0-25	1.6B	1.6B	1.6B	1.6B
0-2.5	0-30	2.5B	2.5B	2.5B	2.5B
0-4	0-60	4B	4B	4B	4B
0-6.8	0-100	6.8B	6.8B	6.8B	6.8B
0-10.5	0-150	10.5B	10.5B	10.5B	10.5B
0-13.5	0-200	13.5B	13.5B	13.5B	13.5B
0-17	0-250	17B	17B	17B	17B
0-21	0-300	21B	21B	21B	21B
0-24	0-350	24B	24B	24B	24B
0-27.5	0-400	27.5B	27.5B	27.5B	27.5B
0-41	0-600	41B	41B	41B	41B
0-54	0-800	54B	54B	54B	54B
0-68	0-1000	68B	68B	68B	68B
0-100	0-1500	100B	100B	100B	100B
0-140	0-2000	140B	140B	140B	140B
0-170	0-2500	170B	170B	170B	170B
0-200	0-3000	200B	200B	200B	200B
0-250	0-3500	250B	250B	250B	250B
0-315	0-4000	315B	315B	315B	315B
0-400	0-6000	400B	400B	400B	400B





## Pressure Gauges & Testing Pumps



### Pressure Gauges

stainless steel casing, filled with glyzerine,  
stainless steel rim-sealed ring, macralon-lens,  
with 2 readings bar / psi



Type GL 63.13

Type GL 100.13



Nominal size Ø mm connection		63 1/4 NPT	100 1/2 NPT
pressure range Bar / PSI		No. GL63.13-...	No. GL100.13-...
0-1	0-15	1B	1B
0-1.6	0-25	1.6B	1.6B
0-2.5	0-30	2.5B	2.5B
0-4	0-60	4B	4B
0-6.8	0-100	6.8B	6.8B
0-10.5	0-150	10.5B	10.5B
0-13.5	0-200	13.5B	13.5B
0-17	0-250	17B	17B
0-21	0-300	21B	21B
0-24	0-350	24B	24B
0-27.5	0-400	27.5B	27.5B
0-41	0-600	41B	41B
0-54	0-800	54B	54B
0-68	0-1000	68B	68B
0-100	0-1500	100B	100B
0-140	0-2000	140B	140B
0-170	0-2500	170B	170B
0-200	0-3000	200B	200B
0-250	0-3500	250B	250B
0-315	0-4000	315B	315B
0-400	0-6000	400B	400B

### Hand-Operated Test Pumps with pressure gauge connection 1/2"



Art. No.	HP 220	HP 300	HP 500F
specifications	Single-stage design	Single-stage design	Double-stage test pump (two plungers) for a higher volume
plunger Ø	22 mm	30 mm	50/16 mm
capacity/volume	13 cm <sup>3</sup>	24 cm <sup>3</sup>	75 cm <sup>3</sup>
test pressure	100 bar	60 bar	200 bar
stationary type	HP 220	HP 300	HP 500
mobile type			HP 500M

## Testing Pumps

### High Pressure Hand-Operated Test Pumps

with pressure gauge connection 1/2" and safety valve

Art. No.	HP 8	HP 12
Plunger Ø	32/8 mm	32/12 mm
Capacity/Volume	28 cm <sup>3</sup>	28 cm <sup>3</sup>
Test pressure	1000 bar	630 bar
Stationary type	HP/8	HP/12
Mobile type	HP/8M	HP/12M



### Hand-Operated Testing Pumps with twin-valve technology

#### RP50

precision testing pump in monoblock design 0 - 60 bar

testing and pressure range:

0 - 60 bar, with 1 bar steps

0 - 860 psi, with 20 psi steps

0 - 6 MPa, with 0,1 MPa steps

hub suction capacity: approx. 45 ml / stroke

tank capacity: 12 l

connection: R 1/2"

Art. No. **6.0200**

#### TP25

small testing pump

for compression testing 0 - 25 bar

testing and pressure range: 0 - 25 bar

hub suction capacity: approx. 16 ml / stroke

tank capacity: 7 l

connection: R 1/2"

Art. No. **6.0250**



### KISTENMACHER Testing Pump TP5

testing pump in monoblock design 0 - 60 bar,  
tank: painted in epoxy powder red colour semi-texturized  
working lever: zinc plated

manometers: 0-60 bar - 0-860 psi

pressure gauge connection: 1/4" bsp

outgoing pipe connection: 1/2" bsp

hose with two connections of 1/2" bsp

capacity: 10 l

Art. No. **TP-5**

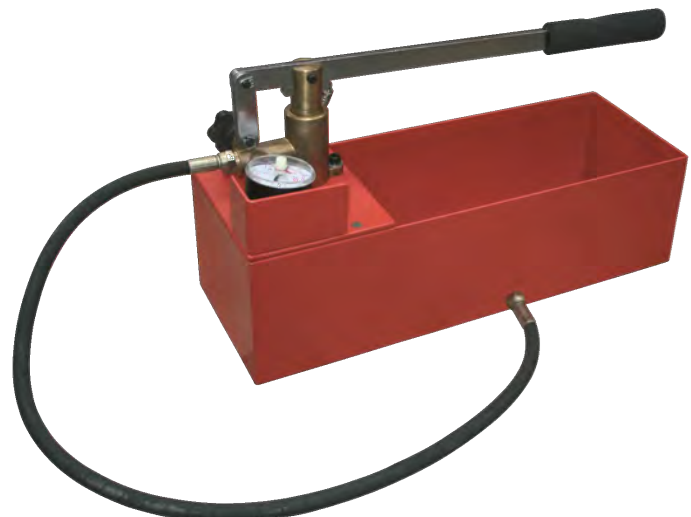

## Industrial Sprayers

### Industrial Sprayers

PE-black double acting

atomizer head with double stroke and freely positionable flexible hose allows almost complete emptying at a working angle of 0° - 180°  
pressure spring and ball made of INOX

recommended for use with thin liquid media, such as lubricants, break cleaners and cleaners from the industrial and automotive industry areas, as long as the material of the sprayer is resistant to these media

colour of container: black

colour of sprayhead: black-silver

Art. No.	ml
06 232	500
06 233	750
06 235	1000

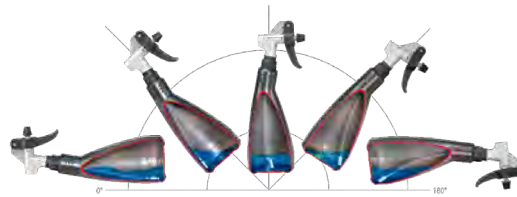

### Household Sprayers

sprayer head with adjustable and closeable plastic nozzle (00 258)  
for water-based, non aggressive liquids

colour of container: orange

colour of sprayhead: blue-white

Art. No.	ml
06 266	500



### Industrial Sprayers - 750 ml-PE

suitable for various chemicals, e.g. detergents, solvents and cleaning agents  
stable conical bottle design

colour of container: orange

colour of sprayhead: blue-white

Art. No.	ml	specification
06 267	750	sprayer head with adjustable and closeable plastic nozzle
06 267 956	750	sprayer head with adjustable and manual shut-off brass spray nozzle



## Pressure Sprayers

### GLORIA®

#### Hobby 05 Flex / 10 Flex

fine sprayer - double acting precision pump,  
1 x pump = 2 x spray  
adjustable nozzle with brass insert,  
transparent level indicator,  
container made of high quality plastic  
360° spray function

Art. No.	capacity l
Hobby 05 Flex	0.5
Hobby 10 Flex	1.00



#### Hobby 100 / 125 Flex

pressure sprayer for homes and gardens,  
operating pressure max. 3 bar,  
adjustable nozzle incl. brass insert,  
transparent level indicator strip,  
container made of high quality plastic  
powerful pressure pump

Art. No.	capacity l
Hobby 100	1.0
Hobby 125 Flex	1.25



#### Prima 3 / 5 / 8

high quality plastic,  
powerful pressure pump,  
integral safety valve,  
brass spray lance and hose,  
carrying straps

**Prima 3** capacity **3.0 l**  
Art. No. **Prima 3**

**Prima 5** capacity **5.0 l**  
Art. No. **Prima 5**

**Prima 8** capacity **8.0 l**  
Art. No. **Prima 8**

with bottom ring for  
safe stand

#### Pro 5

Art. No. **81**

filling capacity 5 l  
max. pressure 3 bar  
material of container oil-resistant plastic  
pump high performance pump  
other equipment brass spray lance, adjustable nozzle,  
safty valve, portable on shoulder



#### Pro 8

Art. No. **92**

filling capacity 8 l  
max. pressure 3 bar  
material of container oil-resistant plastic  
pump high performance pump  
other equipment brass spray lance, adjustable  
nozzle, safty valve,  
portable on shoulder



## Pressure Sprayers

# GLORIA®

Art. No.	405 T	410 T
filling capacity	5 l	10 l
max. pressure	6 bar	
material of container	steel with high-quality plastic interior coating	
pressure gauge	-	✓
other equipment	safety relief and ventilating valve brass spray lance, carrying strap	

**405 T**

**410 T**

Art. No.	505 T	510 T
filling capacity	5 l	10 l
max. pressure	6 bar	
material of container	stainless steel (non-corroding)	
pressure gauge	-	✓
other equipment	safety relief and ventilating valve brass spray lance, carrying strap	

**505 T**

**510 T**

### Piston Knapsack Sprayer Typ 2016

Art. No.	2016
filling capacity	16 l
material of container:	stainless steel (non-corroding)
pump	plastic pump
max. pump pressure:	6 bar

other equipment: brass spray lance with hollow cone nozzle and extension lance 0.5 m, stable swivelling pump lever, powerful plastic pump, infinitely variable pressure regulator from 1,0 - 3,0 bar



### Piston Knapsack Sprayer Typ 1800

Art. No.	1800
filling capacity	18 l
material of container:	heavy duty plastic
pump	plastic pump
max. pump pressure:	6 bar

other equipment: with indicator pressure gauge, brass spray lance and extension lance 0.5 m, stable swivelling pump lever, padded shoulder carrying straps with quick tensioning system, infinitely variable pressure regulator from 1,0 - 3,0 bar



### Piston Knapsack Sprayer Typ 1200

Art. No.	1200
filling capacity	12 l
material of container:	heavy duty plastic
pump	plastic pump
max pump pressure:	4 bar

other equipment: brass spray lance with hollow cone nozzle high-performance pressure pump transparent level indicator strip adjustable carrying straps for comfortable use, portable on back





## Metal Tool Boxes



### KISTENMACHER brand Empty Tool Boxes

made of sheet metal, hammer slag blue,  
with hole for locking

#### 3-tray with 1 handle

Art. No. **430/3-1** 430 x 200 x 160 mm  
Art. No. **530/3-1** 530 x 200 x 160 mm

#### 5-tray with 1 handle

Art. No. **430/5-1** 430 x 200 x 200 mm  
Art. No. **530/5-1** 530 x 200 x 200 mm

#### 3-tray with 2 handle

Art. No. **430/3-2** 430 x 200 x 160 mm  
Art. No. **530/3-2** 530 x 200 x 160 mm

#### 5-tray with 2 handle

Art. No. **430/5-2** 430 x 200 x 200 mm  
Art. No. **530/5-2** 530 x 200 x 200 mm

#### 7-tray with 2 handle

Art. No. **430/7-2** 430 x 200 x 250 mm  
Art. No. **530/7-2** 530 x 200 x 250 mm



### Workshop Trolleys load capacity: 150 kg

colour: blue - other colours on request, drawers made of strong metal sheet with partitions, lockable drawers with central locking system, rubber coated top, metal body powder coated, mobile unit with 4 strong wheels (2 x swivel - 2 x fixed)

#### 1 + 4 drawers big

trolley with 4 drawers + 1 storage compartment extractable on both sides and one extra big compartment - (easy storage for big tools)

Art. No. **WST-5** 750 x 400 x 870 mm

#### 6 drawers

trolley with 6 drawers,  
drawers fully extractable on one side only

Art. No. **WST-6** 750 x 400 x 910 mm





## HSS Drill Bits DIN 338 N

### HSS DIN 338 N Standard Finish

Straight shank twist drill, short series, right hand, roll forged, steam tempered, 118° universal point shape, packing in plastic bags of 10 pcs (up to 8.0 mm) or 5 pcs (from 8.5 mm).



Art. No.	Ø mm
338ST00100	1.0
338ST00150	1.5
338ST00200	2.0
338ST00250	2.5
338ST00300	3.0
338ST00350	3.5
338ST00400	4.0
338ST00450	4.5
338ST00500	5.0
338ST00550	5.5
338ST00600	6.0
338ST00650	6.5
338ST00700	7.0
338ST00750	7.5
338ST00800	8.0
338ST00850	8.5
338ST00900	9.0
338ST00950	9.5
338ST01000	10.0
338ST01100	11.0
338ST01200	12.0
338ST01300	13.0
338ST01400	14.0
338ST01500	15.0
338ST01600	16.0
338ST01700	17.0
338ST01800	18.0
338ST01900	19.0
338ST02000	20.0



### HSS CO DIN 338 N Cobalt Finish

Straight shank twist drill, short series, right hand, 5% Co, ground from solid, gold finish packing in plastic bags of 10 pcs (up to 8.0 mm) or 5 pcs (from 8.5 mm).



Art. No.	Ø mm
338CO00300	3.0
338CO00350	3.5
338CO00400	4.0
338CO00450	4.5
338CO00500	5.0
338CO00550	5.5
338CO00600	6.0
338CO00650	6.5
338CO00700	7.0
338CO00750	7.5
338CO00800	8.0
338CO00850	8.5
338CO00900	9.0
338CO00950	9.5
338CO01000	10.0
338CO01100	11.0
338CO01200	12.0
338CO01300	13.0
338CO01400	14.0
338CO01500	15.0
338CO01600	16.0
338CO01700	17.0
338CO01800	18.0
338CO01900	19.0
338CO02000	20.0



Inch sizes are available upon request!

## HSS Drill Bits DIN 345 N + DIN 340 N long



### HSS DIN 345 N

Morse taper shank twist drill, right hand, steam tempered, 118° split point, individually packed in plastic tubes



Art. No.	Ø mm	Art. No.	Ø mm	Art. No.	Ø mm
345ST01000	10.0	345ST02500	25.0	345ST04000	40.0
345ST01500	10.5	345ST02550	25.5	345ST04500	40.5
345ST01100	11.0	345ST02600	26.0	345ST04100	41.0
345ST01150	11.5	345ST02650	26.5	345ST04150	41.5
345ST01200	12.0	345ST02700	27.0	345ST04200	42.0
345ST01250	12.5	345ST02750	27.5	345ST04250	42.5
345ST01300	13.0	345ST02800	28.0	345ST04300	43.0
345ST01350	13.5	345ST02850	28.5	345ST04350	43.5
345ST01400	14.0	345ST02900	29.0	345ST04400	44.0
345ST01450	14.5	345ST02950	29.5	345ST04450	44.5
345ST01500	15.0	345ST03000	30.0	345ST04500	45.0
345ST01550	15.5	345ST03050	30.5	345ST04550	45.5
345ST01600	16.0	345ST03100	31.0	345ST04600	46.0
345ST01650	16.5	345ST03150	31.5	345ST04650	46.5
345ST01700	17.0	345ST03200	32.0	345ST04700	47.0
345ST01750	17.5	345ST03250	32.5	345ST04750	47.5
345ST01800	18.0	345ST03300	33.0	345ST04800	48.0
345ST01850	18.5	345ST03350	33.5	345ST04850	48.5
345ST01900	19.0	345ST03400	34.0	345ST04900	49.0
345ST01950	19.5	345ST03450	34.5	345ST04950	49.5
345ST02000	20.0	345ST03500	35.0	345ST05000	50.0
345ST02050	20.5	345ST03350	35.5	345ST05100	51.0
345ST02100	21.0	345ST03600	36.0	345ST05200	52.0
345ST02150	21.5	345ST03650	36.5	345ST05300	53.0
345ST02200	22.0	345ST03700	37.0	345ST05400	54.0
345ST02250	22.5	345ST03750	37.5	345ST05500	55.0
345ST02300	23.0	345ST03800	38.0	345ST05600	56.0
345ST02350	23.5	345ST03850	38.5	345ST05700	57.0
345ST02400	24.0	345ST03900	39.0	345ST05800	58.0
345ST02450	24.5	345ST03950	39.5	345ST05900	59.0
				345ST06000	60.0

### HSS DIN 340 N Long Series

Straight shank twist drill, right hand, roll forged, steam tempered, 118° universal point shape, packing in plastic bags of 10 pcs.



Art. No.	Ø mm
340ST00300	3.0
340ST00350	3.5
340ST00400	4.0
340ST00450	4.5
340ST00500	5.0
340ST00550	5.5
340ST00600	6.0
340ST00650	6.5
340ST00700	7.0
340ST00750	7.5
340ST00800	8.0
340ST00850	8.5
340ST00900	9.0
340ST00950	9.5
340ST01000	10.0
340ST01100	11.0
340ST01200	12.0
340ST01300	13.0
340ST01400	14.0
340ST01500	15.0
340ST01600	16.0
340ST01700	17.0
340ST01800	18.0
340ST01900	19.0
340ST02000	20.0





## HSS Tin Drills, Drills with reduced shank, Drill Bits for Glass



### KISTENMACHER brand HSS TIN Twist Drill Bit DIN 338

straight shank, short series, for stainless steel, right hand, ground from solid, coated, gold finish, from size 4.0 mm with laser printing „Made in Germany“, each piece in a black/red plastic wallet

Art. No.	Ø mm
338TIN00100T	1.0
338TIN00200T	2.0
338TIN00300T	3.0
338TIN00400T	4.0
338TIN00500T	5.0
338TIN00600T	6.0
338TIN00800T	8.0
338TIN01000T	10.0
338TIN01200T	12.0



### KISTENMACHER brand HSS Twist Drill Bit DIN 338

short series, right hand, reduced shank to diam. 13 mm, with laser printing „Made in Germany“, 5 pcs each in a plastic bag with orange sticker



Art. No.	Ø mm
338RE01400	14.0
338RE01450	14.5
338RE01500	15.0
338RE01550	15.5
338RE01560	16.0
338RE01700	17.0
338RE01800	18.0
338RE01900	19.0
338RE02000	20.0
338RE02100	21.0

Art. No.	Ø mm
338RE02150	21.5
338RE02200	22.0
338RE02400	24.0
338RE02450	24.5
338RE02500	25.0
338RE02600	26.0
338RE02700	27.0
338RE02800	28.0
338RE03000	30.0

### Glass Drill Bit, hex. shank

galvanized surface, precision diamond ground TC tip, suitable for drilling in plate glass, glass panes, bottle glass, tiles and ceramics  
individually packed in PVC wallet



Art. No.	Ø mm
9500T 032	3.2
9500T 042	4.2
9500T 052	5,2
9500T 062	6,2
9500T 072	7,2
9500T 082	8,2
9500T 092	9,2
9500T 102	10,2
9500T 122	12,2
9500T 132	13,2



## HSS Drill Bit Sets DIN 338



### KISTENMACHER brand HSS DIN 338 drill bit set in plastic box

straight shank twist drill, short series, right hand, roll forged, steam tempered, 118° universal point shape, packed in plastic box



Art. No.	pcs/set	mm/inch	sizes
338SET6106	6	mm	2, 3, 4, 5, 6, 8
338SET2100	10	mm	1, 2, 3, 4, 5, 6, 7, 8, 9, 10
338SET2113	13	mm	1.5, 2, 2.5, 3, 3.2, 4, 4.8, 5, 5.5, 6, 6.5
338SET2119	19	mm	1, 1.5, 2, 2.5, 3, 3.5, 4, 4.5, 5, 5.5, 6, 6.5, 7, 7.5, 8, 8.5, 9, 9.5, 10
338SET2191	7	inch	1/16, 3/32, 1/8, 5/32, 3/16, 7/32, 1/4
338SET2193	13	inch	1/16, 5/64, 3/32, 7/64, 1/8, 9/64, 5/32, 11/64, 3/16, 13/64, 7/32, 15/64, 1/4
338SET2192	10	inch	1/16 - 1/4 1/64 missing, without 11/64, 13/64, 15/64

### KISTENMACHER brand HSS DIN 338 drill bit set in metal box

straight shank twist drill, short series, right hand, roll forged, steam tempered, 118°



Art. No.	pcs/set	mm/inch	sizes
338SET2519	19	mm	1, 1.5, 2, 2.5, 3, 3.5, 4, 4.5, 5, 5.5, 6, 6.5, 7, 7.5, 8, 8.5, 9, 9.5, 10
338SET2525	25	mm	1, 1.5, 2, 2.5, 3, 3.5, 4, 4.5, 5, 5.5, 6, 6.5, 7, 7.5, 8, 8.5, 9, 9.5, 10, 10.5, 11, 11.5, 12.0, 12.5, 13
338SET0273	21	inch	1/16, 5/64, 3/32, 7/64, 1/8, 9/64, 5/32, 11/64, 3/16, 13/64, 7/32, 15/64, 1/4, 17/64, 9/32, 19/64, 5/16, 21/64, 11/32, 23/64, 3/8
338SET0274	29	inch	1/16, 5/64, 3/32, 7/64, 1/8, 9/64, 5/32, 11/64, 3/16, 13/64, 7/32, 15/64, 1/4, 17/64, 9/32, 19/64, 5/16, 21/64, 11/32, 23/64, 3/8, 25/64, 13/32, 27/64, 7/16, 29/64, 15/32, 31/64, 1/2

## Mortise Bits, Screw Extractors & Planer Blades

### Mortise Bits (No. 395)

with double cutter and chip breaking grooves - cylindrical shank for use in bushing for right and left hand

- A) right cutting** - shaft 16 x 50 mm
- B) left cutting** - shaft 16 x 50 mm
- C) right cutting** - shaft 13 x 50 mm
- D) left cutting** - shaft 13 x 50 mm



Art. No. A	Art. No. B	Art. No. C	Art. No. D	size/length (mm)
395/16/6r	395/16/6l	395/13/6r	395/13/6l	6 x 120
395/16/7r	395/16/7l	395/13/7r	395/13/7l	7 x 125
395/16/8r	395/16/8l	395/13/8r	395/13/8l	8 x 130
395/16/9r	395/16/9l	395/13/9r	395/13/9l	9 x 135
395/16/10r	395/16/10l	395/13/10r	395/13/10l	10 x 140
395/16/11r	395/16/11l	395/13/11r	395/13/11l	11 x 145
395/16/12r	395/16/12l	395/13/12r	395/13/12l	12 x 150
395/16/13r	395/16/13l	395/13/13r	395/13/13l	13 x 155
395/16/14r	395/16/14l	395/13/14r	395/13/14l	14 x 160
395/16/15r	395/16/15l	395/13/15r	395/13/15l	15 x 165
395/16/16r	395/16/16l	395/13/16r	395/13/16l	16 x 170
395/16/18r	395/16/18l	395/13/18r	395/13/18l	18 x 180
395/16/20r	395/16/20l	395/13/20r	395/13/20l	20 x 185
395/16/22r	395/16/22l	395/13/22r	395/13/22l	22 x 195
395/16/24r	395/16/24l	395/13/24r	395/13/24l	24 x 200
395/16/26r	395/16/26l	395/13/26r	395/13/26l	26 x 210
395/16/30r	395/16/30l	395/13/30r	395/13/30l	30 x 220

### KISTENMACHER brand Screw Extractors packing in plastic box



Art. No.	size	pcs / set
5015 (AB-A)	1 to 5	5 pcs set
5016 (AB-B)	1 to 6	6 pcs set
5018 (AB-C)	1 to 8	8 pcs set

### KISTENMACHER brand Planer Blades Chrome-vanadium steel (C75 48-50 HRC)



Art. No.	size/length (mm)
250353	10" / 250 x 35 x 3
300353	12" / 300 x 35 x 3
350353	14" / 350 x 35 x 3
400303	16" / 400 x 30 x 3
400353	16" / 400 x 35 x 3
450353	18" / 450 x 35 x 3
450303	20" / 500 x 30 x 3
500353	20" / 500 x 35 x 3
550353	22" / 550 x 35 x 3
550303	24" / 600 x 30 x 3
600353	24" / 600 x 35 x 3
800353	36" / 800 x 35 x 3

## Countersink - Step Drills

### Precision - Countersink, HSS

solid carbide similar DIN 335 C 90 degrees

3-cutting edges-geometry

we recommend HM-countersinks when machining tough materials, high-strength steels, titanium or



Art. No.	Ø head (mm)	shank (mm)	mm	smallest Ø (mm)	Art. No.	Ø head (mm)	shank (mm)	mm	smallest Ø (mm)	Art. No.	Ø head (mm)	shank (mm)	mm	smallest Ø (mm)
1030043	4,3	4	40	1,3	1030094	9,4	6	50	2,2	1030205	20,5	10	67	3,8
1030050	5,0	4	40	1,5	1030100	10,0	6	50	2,5	1030250	23,0	10	67	3,8
1030053	5,3	4	40	1,5	1030104	10,4	6	50	2,5	1030260	26,0	10	67	3,8
1030058	5,8	5	45	1,5	1030115	11,5	8	56	2,8	1030280	28,0	12	71	4,0
1030060	6,0	5	45	1,5	1030124	12,4	8	56	2,8	1030300	30,0	12	71	4,2
1030063	6,3	5	45	1,5	1030134	13,4	8	56	2,9	1030310	31,0	12	71	4,2
1030070	7,0	6	50	1,8	1030144	14,4	10	60	3,2	1030400	40,0	13	80	6,5
1030073	7,3	6	50	1,8	1030150	15,0	10	60	3,2	1030500	50,0	13	85	12,0
1030080	8,0	6	50	2,0	1030165	16,5	10	60	3,2					
1030083	8,3	6	50	2,0	1030190	19,0	10	63	3,5					

### Precision - Countersink HSS Set

solid carbide similar DIN 335 C 90 degrees

3-cutting edges-geometry

we recommend HM-countersinks when machining

Art. No.	pcs per set	range Ø (mm)	sizes
1030001	6	6,0 - 19,0	6,0 - 8,0 - 10,0 - 11,5 - 15,0 - 19,0 mm
1030002	6	6,3 - 20,5	6,3 - 8,3 - 10,4 - 12,4 - 16,5 - 20,5 mm
1030003	7	6,3 - 25,0	6,3 - 8,3 - 10,4 - 12,4 - 16,5 - 20,5 - 25,0 mm
1030004	7	6,0 - 25,0	6,0 - 8,0 - 10,0 - 11,5 - 15,0 - 19,0 - 25,0 mm



### Precision - HSS Countersink, 1/4" hexagon shank

solid carbide similar DIN 3126 C 6,3 90 degrees

Art. No.	drill-range	shank	mm
1570/8	8 mm	4 mm	37
1570/10	10 mm	5 mm	41
1570/12	12 mm	6 mm	45
1570/16	16 mm	8 mm	49
1570/20	20 mm	10 mm	50



### Precision - HSS Step Drill 2mm rising

2-cutting edges-geometry, straight fluted

Art. No.	drill-range	shank	mm	steps
1140411	4 - 12 mm	6 mm	62	5
1140420	4 - 20 mm	8 mm	73	9
1140630	6 - 30 mm	10 mm	95	13



# HSS Core Drills

## ALFRA - Rotabest - HSS BASIC CORE DRILLS

with weldon shank 19.0 mm, 2 driving surfaces,  
internal bore 6.35 mm  
special super high speed steel  
polished section: pre- and post cutter



Art. No.	cutting depth	dia.	Art. No.	cutting depth	dia.
1907012025	30 mm	12 mm	1907033025	30 mm	33 mm
1907013025	30 mm	13 mm	1907034025	30 mm	34 mm
1907014025	30 mm	14 mm	1907035025	30 mm	35 mm
1907015025	30 mm	15 mm	1907036025	30 mm	36 mm
1907016025	30 mm	16 mm	1907037025	30 mm	37 mm
1907017025	30 mm	17 mm	1907038025	30 mm	38 mm
1907018025	30 mm	18 mm	1907039025	30 mm	39 mm
1907019025	30 mm	19 mm	1907040025	30 mm	40 mm
1907020025	30 mm	20 mm	1907041025	30 mm	41 mm
1907021025	30 mm	21 mm	1907042025	30 mm	42 mm
1907022025	30 mm	22 mm	1907043025	30 mm	43 mm
1907023025	30 mm	23 mm	1907044025	30 mm	44 mm
1907024025	30 mm	24 mm	1907045025	30 mm	45 mm
1907025025	30 mm	25 mm	1907046025	30 mm	46 mm
1907026025	30 mm	26 mm	1907047025	30 mm	47 mm
1907027025	30 mm	27 mm	1907048025	30 mm	48 mm
1907028025	30 mm	28 mm	1907049025	30 mm	49 mm
1907029025	30 mm	29 mm	1907050025	30 mm	50 mm
1907030025	30 mm	30 mm	1907052025	30 mm	52 mm
1907031025	30 mm	31 mm	1907055025	30 mm	55 mm
1907032025	30 mm	32 mm	1907060025	30 mm	60 mm

Art. No.	cutting depth	dia.	Art. No.	cutting depth	dia.
1907012050	50 mm	12 mm	1907037050	50 mm	37 mm
1907013050	50 mm	13 mm	1907038050	50 mm	38 mm
1907014050	50 mm	14 mm	1907039050	50 mm	39 mm
1907015050	50 mm	15 mm	1907040050	50 mm	40 mm
1907016050	50 mm	16 mm	1907041050	50 mm	41 mm
1907017050	50 mm	17 mm	1907042050	50 mm	42 mm
1907018050	50 mm	18 mm	1907043050	50 mm	43 mm
1907019050	50 mm	19 mm	1907044050	50 mm	44 mm
1907020050	50 mm	20 mm	1907045050	50 mm	45 mm
1907021050	50 mm	21 mm	1907046050	50 mm	46 mm
1907022050	50 mm	22 mm	1907047050	50 mm	47 mm
1907023050	50 mm	23 mm	1907048050	50 mm	48 mm
1907024050	50 mm	24 mm	1907049050	50 mm	49 mm
1907025050	50 mm	25 mm	1907050050	50 mm	50 mm
1907026050	50 mm	26 mm	1907051050	50 mm	51 mm
1907027050	50 mm	27 mm	1907052050	50 mm	52 mm
1907028050	50 mm	28 mm	1907053050	50 mm	53 mm
1907029050	50 mm	29 mm	1907054050	50 mm	54 mm
1907030050	50 mm	30 mm	1907055050	50 mm	55 mm
1907031050	50 mm	31 mm	1907056050	50 mm	56 mm
1907032050	50 mm	32 mm	1907057050	50 mm	57 mm
1907033050	50 mm	33 mm	1907058050	50 mm	58 mm
1907034050	50 mm	34 mm	1907059050	50 mm	59 mm
1907035050	50 mm	35 mm	1907060050	50 mm	60 mm
1907036050	50 mm	36 mm			



Art. No.	ejector pin
1926500	6.35 x 77 mm



Art. No.	ejector pin
1950500	6.35 x 102 mm

## TCT Core Drills

### ALFRA - Rotabest - TCT CORE DRILLS

with weldon shank 19.0 mm

internal bore: Ø 14 - 17 mm = 6.35 mm

Ø 18 - 50 mm = 8.0 mm

polished section: pre - middle - post cutter

for the highest standards in cutting and lifespan



Art. No.	cutting depth	dia.
2003014035	35 mm	14 mm
2003015035	35 mm	15 mm
2003016035	35 mm	16 mm
2003017035	35 mm	17 mm
2003018035	35 mm	18 mm
2003019035	35 mm	19 mm
2003020035	35 mm	20 mm
2003021035	35 mm	21 mm
2003022035	35 mm	22 mm
2003023035	35 mm	23 mm
2003024035	35 mm	24 mm
2003025035	35 mm	25 mm
2003026035	35 mm	26 mm
2003027035	35 mm	27 mm
2003028035	35 mm	28 mm
2003029035	35 mm	29 mm
2003030035	35 mm	30 mm
2003031035	35 mm	31 mm
2003032035	35 mm	32 mm
2003033035	35 mm	33 mm
2003034035	35 mm	34 mm
2003035035	35 mm	35 mm

Art. No.	cutting depth	dia.	Art. No.	cutting depth	dia.
2003014050	50 mm	14 mm	2003033050	50 mm	33 mm
2003015050	50 mm	15 mm	2003034050	50 mm	34 mm
2003016050	50 mm	16 mm	2003035050	50 mm	35 mm
2003017050	50 mm	17 mm	2003036050	50 mm	36 mm
2003018050	50 mm	18 mm	2003037050	50 mm	37 mm
2003019050	50 mm	19 mm	2003038050	50 mm	38 mm
2003020050	50 mm	20 mm	2003039050	50 mm	39 mm
2003021050	50 mm	21 mm	2003040050	50 mm	40 mm
2003022050	50 mm	22 mm	2003041050	50 mm	41 mm
2003023050	50 mm	23 mm	2003042050	50 mm	42 mm
2003024050	50 mm	24 mm	2003043050	50 mm	43 mm
2003025050	50 mm	25 mm	2003044050	50 mm	44 mm
2003026050	50 mm	26 mm	2003045050	50 mm	45 mm
2003027050	50 mm	27 mm	2003046050	50 mm	46 mm
2003028050	50 mm	28 mm	2003047050	50 mm	47 mm
2003029050	50 mm	29 mm	2003048050	50 mm	48 mm
2003030050	50 mm	30 mm	2003049050	50 mm	49 mm
2003031050	50 mm	31 mm	2003050050	50 mm	50 mm
2003032050	50 mm	32 mm			



Art. No.	ejector pin
1935500	for Ø 14-17 mm, 6.35 x 87 mm
2001500	for Ø 18 - 50 mm, 8 x 87 mm



Art. No.	ejector pin
1950500	for Ø 14-17 mm, 6.35 x 102 mm
2001501	for Ø 18 - 50 mm, 8 x 102 mm

## HSS Core Drills

### ALFRA - Rotabest - HSS-CO ECO CORE DRILLS

with weldon shank 19.0 mm, 2 driving surfaces,  
 internal bore 6.35 mm  
 cutting depth Ø 110 mm: 8 mm  
 special super high speed steel cobalt  
 polished section: pre- and post cutter



Art. No.	cutting depth	dia.	Art. No.	cutting depth	dia.
1901012025	30 mm	12 mm	1901033025	30 mm	33 mm
1901013025	30 mm	13 mm	1901034025	30 mm	34 mm
1901014025	30 mm	14 mm	1901035025	30 mm	35 mm
1901015025	30 mm	15 mm	1901036025	30 mm	36 mm
1901016025	30 mm	16 mm	1901037025	30 mm	37 mm
1901017025	30 mm	17 mm	1901038025	30 mm	38 mm
1901018025	30 mm	18 mm	1901039025	30 mm	39 mm
1901019025	30 mm	19 mm	1901040025	30 mm	40 mm
1901020025	30 mm	20 mm	1901041025	30 mm	41 mm
1901021025	30 mm	21 mm	1901042025	30 mm	42 mm
1901022025	30 mm	22 mm	1901043025	30 mm	43 mm
1901023025	30 mm	23 mm	1901044025	30 mm	44 mm
1901024025	30 mm	24 mm	1901045025	30 mm	45 mm
1901025025	30 mm	25 mm	1901046025	30 mm	46 mm
1901026025	30 mm	26 mm	1901047025	30 mm	47 mm
1901027025	30 mm	27 mm	1901048025	30 mm	48 mm
1901028025	30 mm	28 mm	1901049025	30 mm	49 mm
1901029025	30 mm	29 mm	1901050025	30 mm	50 mm
1901030025	30 mm	30 mm	1901052025	30 mm	52 mm
1901031025	30 mm	31 mm	1901055025	30 mm	55 mm
1901032025	30 mm	32 mm	1901060025	30 mm	60 mm

Art. No.	cutting depth	dia.	Art. No.	cutting depth	dia.
1901012050	50 mm	12 mm	1901037050	50 mm	37 mm
1901013050	50 mm	13 mm	1901038050	50 mm	38 mm
1901014050	50 mm	14 mm	1901039050	50 mm	39 mm
1901015050	50 mm	15 mm	1901040050	50 mm	40 mm
1901016050	50 mm	16 mm	1901041050	50 mm	41 mm
1901017050	50 mm	17 mm	1901042050	50 mm	42 mm
1901018050	50 mm	18 mm	1901043050	50 mm	43 mm
1901019050	50 mm	19 mm	1901044050	50 mm	44 mm
1901020050	50 mm	20 mm	1901045050	50 mm	45 mm
1901021050	50 mm	21 mm	1901046050	50 mm	46 mm
1901022050	50 mm	22 mm	1901047050	50 mm	47 mm
1901023050	50 mm	23 mm	1901048050	50 mm	48 mm
1901024050	50 mm	24 mm	1901049050	50 mm	49 mm
1901025050	50 mm	25 mm	1901050050	50 mm	50 mm
1901026050	50 mm	26 mm	1901051050	50 mm	51 mm
1901027050	50 mm	27 mm	1901052050	50 mm	52 mm
1901028050	50 mm	28 mm	1901053050	50 mm	53 mm
1901029050	50 mm	29 mm	1901054050	50 mm	54 mm
1901030050	50 mm	30 mm	1901055050	50 mm	55 mm
1901031050	50 mm	31 mm	1901056050	50 mm	56 mm
1901032050	50 mm	32 mm	1901057050	50 mm	57 mm
1901033050	50 mm	33 mm	1901058050	50 mm	58 mm
1901034050	50 mm	34 mm	1901059050	50 mm	59 mm
1901035050	50 mm	35 mm	1901060050	50 mm	60 mm
1901036050	50 mm	36 mm			



Art. No.	ejector pin
1926500	6.35 x 77 mm



Art. No.	ejector pin
1950500	6.35 x 102 mm

## Masonry Drill Bits

### Masonry Drill Bit DIN 8039

Masonry drill, sandblasted, tungsten carbide tip, rolled flute, for rotary and percussion, individually packed in PVC wallet



### Masonry Drill Bit Long Version

Masonry drill, high temperature carbide tip, sand blasted, rolled flute, rotary and percussion, individually packed in PVC wallet



available in 400 mm and 600 mm length

Art. No. standard length	Ø mm
3000T 030	3.0
3000T 040	4.0
3000T 050	5.0
3000T 055	5.5
3000T 060	6.0
3000T 065	6.5
3000T 070	7.0
3000T 080	8.0
3000T 090	9.0
3000T 100	10.0
3000T 110	11.0
3000T 120	12.0
3000T 130	13.0
3000T 140	14.0
3000T 150	15.0
3000T 160	16.0
3000T 180	18.0
3000T 200	20.0
3000T 220	22.0
3000T 240	24.0
3000T 250	25.0

Art. No. 150 mm	Ø mm
3150T 050	5.0
3150T 055	5.5
3150T 060	6.0
3150T 065	6.5
3150T 070	7.0
3150T 080	8.0
3150T 100	10.0

Art. No. 200 mm	Ø mm
3200T 050	5.0
3200T 055	5.5
3200T 060	6.0
3200T 065	6.5
3200T 070	7.0
3200T 080	8.0
3200T 100	10.0
3200T 110	11.0
3200T 120	12.0
3200T 130	13.0
3200T 140	14.0
3200T 150	15.0
3200T 160	16.0



Art. No. 400 mm	Ø mm
4800T 060	6.0
4800T 065	6.5
4800T 080	8.0
4800T 100	10.0
4800T 120	12.0
4800T 130	13.0
4800T 140	14.0
4800T 150	15.0
4800T 160	16.0
4800T 180	11.0
4800T 190	12.0
4800T 200	13.0
4800T 220	14.0
4800T 240	15.0
4800T 250	16.0
4800T 260	17.0
4800T 280	18.0
4800T 300	19.0
4800T 320	20.0

Art. No.	Ø mm
4900T 080	8.0
4900T 100	10.0
4900T 120	12.0
4900T 130	13.0
4900T 140	14.0
4900T 150	15.0
4900T 160	16.0
4900T 180	11.0
4900T 190	12.0
4900T 200	13.0
4900T 220	14.0
4900T 240	15.0
4900T 250	16.0
4900T 260	17.0
4900T 280	18.0
4900T 300	19.0
4900T 320	20.0



## Concrete & Granite Drill Bits



### Concrete (SAPHIR)

Masonry drill for percussion, high temperature brazed tungsten carbide tip, sand blasted, for concrete, natural stone, brick and marble; individually packed in PVC wallet



Art. No. standard length	Ø mm	Art. No. 200 mm extra long	Ø mm
3500T 030	3.0		
3500T 040	4.0		
3500T 050	5.0	3520T 050	5.0
3500T 055	5.5		
3500T 060	6.0	3520T 060	6.0
3500T 065	6.5	3520T 065	6.5
3500T 070	7.0	3520T 070	7.0
3500T 080	8.0	3520T 080	8.0
3500T 090	9.0		
3500T 100	10.0	3520T 100	10.0
		3520T 110	11.0
3500T 120	12.0	3520T 120	12.0
3500T 130	13.0	3520T 130	13.0
3500T 140	14.0	3520T 140	14.0
3500T 150	15.0	3520T 150	15.0
3500T 160	16.0	3520T 160	16.0
3500T 180	18.0		
3500T 200	20.0		
3500T 220	22.0		
3500T 240	24.0		
3500T 250	25.0		



Art. No. standard length	Ø mm	Art. No. 200 mm extra long	Ø mm
3400T 030	3.0	3420T 050	5.0
3400T 040	4.0	3420T 060	6.0
3400T 050	5.0	3420T 065	6.5
3400T 055	5.5	3420T 070	7.0
3400T 060	6.0	3420T 080	8.0
3400T 065	6.5	3420T 100	10.0
3400T 070	7.0	3420T 110	11.0
3400T 080	8.0	3420T 120	12.0
3400T 090	9.0	3420T 130	13.0
3400T 100	10.0	3420T 140	14.0
3400T 110	11.0	3420T 150	15.0
3400T 120	12.0	3420T 160	16.0
3400T 130	13.0		
3400T 140	14.0		
3400T 150	15.0		
3400T 160	16.0		
3400T 180	18.0		



Art. No. 150 mm extra long	Ø mm
3415T 050	5.0
3415T 060	6.0
3415T 065	6.5
3415T 070	7.0
3415T 080	8.0
3415T 100	10.0

Art. No. 150 mm extra long	Ø mm
3510T 050	5.0
3510T 060	6.0
3510T 065	6.5
3510T 070	7.0
3510T 080	8.0
3510T 100	10.0

## Drill Bit Sets



### Masonry Drill Bit Sets, sand blasted

each set packed in plastic box

Art. No.	pcs/ set	mm/ inch	Sizes
1 3151	4	mm	4, 5, 6, 8
1 3152	4	mm	5, 6, 8, 10
1 3153	5	mm	4, 5, 6, 7, 8
1 3154	5	mm	4, 5, 6, 8, 10
1 3100	8	mm	3, 4, 5, 6, 7, 8, 9, 10



### Combi Drill Bit Sets

each set in plastic box

Art. No.	pcs/ set	mm/ inch	sizes HSS	sizes stone (sandblasted)	sizes wood
300.190.180	9	mm	5, 6, 8	5, 6, 8	5, 6, 8



### Machine Wood Working Drill Bit Sets

each set in multipack

Art. No.	pcs/ set	mm/ inch	sizes
180.350.410	5	mm	4, 5, 6, 8, 10
180.370.310	7	mm	3, 4, 5, 6, 7, 8, 10



### KISTENMACHER brand Universal Drill Sets - SAPHIR

for percussion, concrete, marble  
each set in plastic box

Art. No.	pcs/ set	mm/ inch	sizes
3518-3	4	mm	5,6,8,10
3518-2	5	mm	4,5,6,8,10
3518-1	7	mm	4,5,6,7,8,9,10



### KISTENMACHER brand Universal Drill Sets - RUBIN

for percussion, granite, marble  
each set in plastic box

Art. No.	pcs/ set	mm/ inch	sizes
3434153	4	mm	5, 6, 8, 10
3434163	5	mm	4, 5, 6, 8, 10
3418-1	7	mm	4, 5, 6, 7, 8, 9, 10





## SDS Plus Drill Bits

### KISTENMACHER brand SDS PLUS Rotary Hammer Drill Bit

with 2 flutes, each piece on a plastic clip hanger  
(optionally in PVC wallet)

Art. No. **3800H**



Art. No.	Ø mm length	Art. No.	Ø mm length	Art. No.	Ø mm length
3800H 4 x 110	4 x 110	3800H 10 x 260	10 x 260	3800H 16 x 200	16 x 200
3800H 4 x 160	4 x 160	3800H 10 x 310	10 x 310	3800H 16 x 260	16 x 260
3800H 5 x 110	5 x 110	3800H 10 x 350	10 x 350	3800H 16 x 300	16 x 300
3800H 5 x 160	5 x 160	3800H 10 x 460	10 x 460	3800H 16 x 450	16 x 450
3800H 5 x 210	5 x 210	3800H 10 x 600	10 x 600	3800H 16 x 600	16 x 600
3800H 5 x 310	5 x 310	3800H 11 x 160	11 x 160	3800H 18 x 200	18 x 200
3800H 6 x 110	6 x 110	3800H 11 x 210	11 x 210	3800H 18 x 250	18 x 250
3800H 6 x 160	6 x 160	3800H 12 x 160	12 x 160	3800H 18 x 300	18 x 300
3800H 6 x 210	6 x 210	3800H 12 x 200	12 x 200	3800H 18 x 450	18 x 450
3800H 7 x 110	7 x 110	3800H 12 x 260	12 x 260	3800H 18 x 600	18 x 600
3800H 7 x 160	7 x 160	3800H 12 x 300	12 x 300	3800H 19 x 200	19 x 200
3800H 7 x 210	7 x 210	3800H 12 x 450	12 x 450	3800H 20 x 200	20 x 200
3800H 8 x 110	8 x 110	3800H 12 x 600	12 x 600	3800H 20 x 300	20 x 300
3800H 8 x 160	8 x 160	3800H 13 x 160	13 x 160	3800H 20 x 450	20 x 450
3800H 8 x 210	8 x 210	3800H 13 x 200	13 x 200	3800H 20 x 600	20 x 600
3800H 8 x 260	8 x 260	3800H 13 x 260	13 x 260	3800H 20 x 1000	20 x 1000
3800H 8 x 310	8 x 310	3800H 13 x 450	13 x 450	3800H 22 x 250	22 x 250
3800H 8 x 460	8 x 460	3800H 14 x 160	14 x 160	3800H 22 x 300	22 x 300
3800H 9 x 160	9 x 160	3800H 14 x 200	14 x 200	3800H 22 x 450	22 x 450
3800H 9 x 210	9 x 210	3800H 14 x 260	14 x 260	3800H 22 x 600	22 x 600
3800H 9 x 260	9 x 260	3800H 14 x 300	14 x 300	3800H 24 x 250	24 x 250
3800H 9 x 310	9 x 310	3800H 14 x 450	14 x 450	3800H 24 x 450	24 x 450
3800H 9 x 410	9 x 410	3800H 14 x 600	14 x 600	3800H 25 x 250	19 x 200
3800H 10 x 110	10 x 110	3800H 15 x 160	15 x 160	3800H 25 x 450	19 x 200
3800H 10 x 160	10 x 160	3800H 15 x 260	15 x 260	3800H 26 x 450	26 x 450
3800H 10 x 210	10 x 210	3800H 16 x 160	16 x 160	3800H 30 x 450	30 x 450

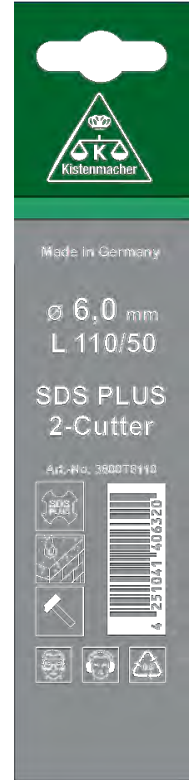

### KISTENMACHER brand SDS-4-PLUS Rotary Hammer Drill Bit

with 4 flutes, each piece on a plastic clip hanger  
(optionally in PVC wallet)

Art. No. **3800H4**



Art. No.	Ø mm length	Art. No.	Ø mm length	Art. No.	Ø mm length
3800H4 5 x 110	5 x 110	3800H4 8 x 160	8 x 160	3800H4 10 x 310	10 x 310
3800H4 5 x 160	5 x 160	3800H4 8 x 210	8 x 210	3800H4 10 x 460	10 x 460
3800H4 5 x 210	5 x 210	3800H4 8 x 260	8 x 260	3800H4 12 x 160	12 x 160
3800H4 6 x 110	6 x 110	3800H4 8 x 310	8 x 310	3800H4 12 x 210	12 x 210
3800H4 6 x 160	6 x 160	3800H4 8 x 460	8 x 460	3800H4 12 x 260	12 x 260
3800H4 6 x 210	6 x 210	3800H4 10 x 160	10 x 160	3800H4 12 x 310	12 x 310
3800H4 6 x 260	6 x 260	3800H4 10 x 210	10 x 210	3800H4 12 x 450	12 x 450
3800H4 8 x 110	8 x 110	3800H4 10 x 260	10 x 260		



## SDS plus - SDS max Accessories



### SDS PLUS Chisel, sandblasted

for rotary hammer drills with SDS-plus chuck

#### Pointed

Art. No. **3801H**

250 mm



#### Flat

Art. No. **3802H**

250 mm

20 mm width



### Concrete Core Cutter - SDS - max Shank

for rotary hammer drills weighing 5 kg or more with SDS-max or 2-slot chuck; simple and efficient handling due to one-piece tool design, chuck of adapters and centring drills is no longer necessary



Art. No.	Ø mm	length (mm)	Art. No.	Ø mm	length (mm)
7330	40	310	7343	55	990
7331	40	550	7338	65	310
7332	45	310	7339	65	550
7333	45	550	7344	65	990
7342	45	990	7340	80	310
7336	55	310	7341	80	550
7337	55	550	7345	80	990



### Hollow Hammer Core Bit

with integrated SDS-max shank and centering drill bit taper 1:20 for rotary hammer drills on min. 5 kg with SDS-max chuck

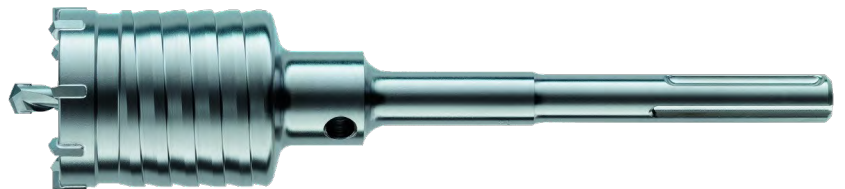

#### Center Drill Bit - Taper Shank 1:20

10 x 120 mm

Art. No. : **1143**



Art. No.	Ø mm	length (mm)	Art. No.	Ø mm	length (mm)
7101	40	290	7108	80	550
7102	40	550	7109	90	290
7103	50	290	7110	90	550
7104	50	550	7111	100	290
7105	68	290	7112	100	550
7106	68	550	7113	125	550
7107	80	290	7114	150	550



#### Drift Keys

Art. No. : **7006**



## SDS + Drill Bits for Wood Working



### Kistenmacher brand SDS Plus Drill Set

5 pcs. set, packed in PVC box



Art. No.	contents
3810-5	5x110 - 6x110 - 6x160 - 8x160 - 10x160 mm
3810-7	5x110 - 6x110 - 8x110 - 6x160 - 8x160 -

### Forstner Bit Basic

Traditional type with center point and two main cutting edges

individually packed in PVC tubes

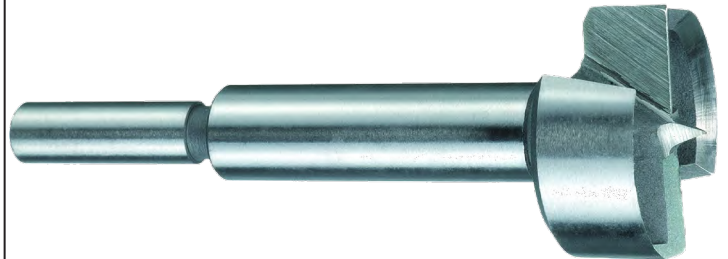

Art. No.	Ø mm	Art. No.	Ø mm
6500100	10,0	6500280	28,0
6500120	12,0	6500300	30,0
6500140	14,0	6500320	32,0
6500150	15,0	6500340	34,0
6500160	16,0	6500350	35,0
6500180	18,0	6500360	36,0
6500200	20,0	6500380	38,0
6500220	22,0	6500400	40,0
6500240	24,0	6500450	45,0
6500250	25,0	6500500	50,0
6500260	26,0		

### Wood Working Drill - Form B

Made of high quality CV steel, CNC precision grinded center point, bicolour finish, optimized flute geometry for quick chip ejection

individually packed in PVC wallet



Art. No.	Ø mm	Art. No.	Ø mm
6000T 030	3.0	6000T 140	14.0
6000T 040	4.0	6000T 150	15.0
6000T 050	5.0	6000T 150	16.0
6000T 060	6.0	6000T 150	18.0
6000T 070	7.0	6000T 150	20.0
6000T 080	8.0	6000T 150	22.0
6000T 090	9.0	6000T 150	24.0
6000T 100	10.0	6000T 150	25.0
6000T 110	11.0	6000T 150	26.0
6000T 120	12.0	6000T 150	28.0
6000T 130	13.0	6000T 150	30.0

### Wood Working Drill

Made of high quality CV steel, CNC precision grinded center point, bicolour finish, optimized flute geometry for quick chip ejection

individually packed in PVC wallet



available in 230 mm and 460 mm length

Art. No. 230 mm	Ø mm	Art. No. 460 mm	Ø mm
6250T 060	6.0		
6250T 080	8.0	6400T 080	8.0
6250T 100	10.0	6400T 100	10.0
6250T 120	12.0	6400T 120	12.0
6250T 140	14.0	6400T 140	14.0
6250T 160	16.0	6400T 160	16.0
6250T 180	18.0	6400T 180	18.0
6250T 200	20.0	6400T 200	20.0

## Tap Wrenches & Die Stocks

### Adjustable Tap Wrenches (No. 130)

zinc die cast - DIN 1814



### Adjustable Tap Wrenches (No. 140)

made of steel - DIN 1814

Art. No.	compatible tap size	Ø (mm)
130/0	M 1 - 8 - 1/16-1/4"	2.0 - 5.0
130/1	M 1 - 10 - 1/16-3/8"	2.0 - 6.3
130/1.12	M 1 - 12 - 1/16-3/2"	2.1 - 8.0
130/2	M 4 - 12 - 5/32-1/2"	3.0 - 9.0
130/3	M 5 - 20 - 7/32-3/4"	4.9 - 12.0
130/4	M 9 - 27 - 7/16-1"	5.5 - 16.0
130/5	M 13 - 32 - 1/2-1.1/4"	7.0 - 20.0

Art. No.	compatible tap size	Ø (mm)
140/0	M 1 - 8 - 1/16-1/4"	2.0 - 5.0
140/1	M 1 - 10 - 1/16-3/8"	2.0 - 6.3
140/1.12	M 1 - 12 - 1/16-3/2"	2.1 - 8.0
140/2	M 4 - 12 - 5/32-1/2"	3.0 - 9.0
140/3	M 5 - 20 - 7/32-3/4"	4.9 - 12.0
140/4	M 9 - 27 - 7/16-1"	5.5 - 16.0
140/5	M 13 - 32 - 1/2-1.1/4"	7.0 - 20.0
140/6	M 18 - 42 - 3/4 - 1.1/2"	11.0 - 24.0
140/7	M 25 - 52 - 1" - 2"	16.0 - 32.0
140/8	M 25 - 64 - 1" - 2.1/2"	16.0 - 40.0

### Tap Wrenches with Ratchet (No. 100)

for right and left hand turn



Art. No.	compatible tap size	Length (mm)
100/01	M 03-10 - 1/8-3/8"	85
100/02	M 05-12 - 7/32-1/2"	100
100/10	M 03-10 - 1/8-3/8"	250
100/20	M 05-12 - 7/32-1/2"	300

### Die Stocks

zinc die cast



DIN 225/DIN EN 22568 (No. 150)  
compatible with size DIN 223

inch (No. 160)

Art. No.	compatible tap size	Ø (mm/inch)
150/2005	M 3-4 - BSW 1/8 - 5/32"	20 x 5
150/2007	M 4.5-6 - BSW 3/16 - 1/4"	20 x 7
150/2509	M 7-9 - BSW 5/16"	25 x 9
150/3011	M 10-11 - BSW 3/8 - 7/16"	30 x 11
150/3814	M 12-14 - BSW 1/2" - 9/16"	38 x 14
150/4518	M 16-20 - BSW 5/8 - 13/16"	45 x 18
150/5522	M 22-24 - BSW 7/8 - 1"	55 x 22

Art. No.	compatible tap size	Ø (mm/inch)
160/0058	15.9 x 6.35 mm - 5/8 x 1/4"	5/8"
160/0001	25.4 x 9.5 mm - 1 x 3/8"	1"
160/0112	38.1 x 12.7 mm - 1.1/2 x 1/2"	1.1/2"
160/0002	50.8 x 15.9 mm - 2 x 5/8"	2"
160/0212	63.5 x 19.0 mm - 2.1/2 - 3/4"	2.1/2"

## Hand Taps & Round Dies

### Hand Tap (No. 4103)

metric - fine ISO - thread DIN 13

**all sizes available from M3 to M 110**

### Hand Tap (No. 4303)

whitworth (BSW) - thread BS84

**all sizes available from 1/16" to 2"**

### Hand Tap (No. 4703)

armoured tube thread DIN 40 430

**all sizes available from PG 7 to 48**



### Center Drill Bits HSS DIN 333 form A 60 degrees

- point angle 120 degrees
- countersinking angle 60 degrees

Art. No.	size (mm)	shank Ø (mm)	L (mm)
1910100	1.00	3.15	31.5
1910125	1.25	3.15	31.5
1910160	1.60	4.00	35.5
1910200	2.00	5.00	40.0
1910250	2.50	6.30	45.0
1910315	3.15	8.00	50.0
1910400	4.00	10.00	56.0
1910500	5.00	12.50	63.0
1910630	6.30	16.00	71.0



### Round Dies

metric ISO thread DIN 223 (No. 6002)

Art. No.	nominal width	DIN 223 o/d. mm
6002/03	M 3 x 0.5	20 x 05
6002/04	M 4 x 0.7	20 x 05
6002/06	M 6 x 1.0	25 x 07
6002/08	M 8 x 1.25	25 x 09
6002/10	M 10 x 1.5	30 x 11
6002/12	M 12 x 1.75	38 x 14
6002/14	M 14 x 2.0	38 x 14
6002/16	M 16 x 2.0	45 x 18
6002/18	M 18 x 2.5	45 x 18
6002/20	M 20 x 2.5	45 x 18



### Round Dies

whitworth thread BS 84 (No. 6302)

Art. No.	nominal width	DIN 223 o/d. mm
6302/014	BSW 1/4 x 20	20 x 07
6302/014	BSW 5/16 x 18	25 x 09
6302/014	BSW 3/8 x 16	30 x 11
6302/014	BSW 7/16 x 14	30 x 11
6302/014	BSW 1/2 x 12	38 x 14
6302/014	BSW 5/8 x 11	45 x 18
6302/014	BSW 3/4 x 10	45 x 18

### Drill Chuck Arbors (No. 42)

hardened all over and ground  
MK = machine capacity  
B = chuck capacity

Art. No.	compatible tap size
42/0216	MK2 - B16
42/0316	MK3 - B16
42/0218	MK2 - B18
42/0318	MK3 - B18
42/0333	MK3 - B22



### Morse Taper Drill Sleeves DIN 238 (No. 45)

hardened all over and ground  
MK = machine capacity

Art. No.	compatible tap size
45/0201	MK 2 x 1
45/0302	MK 3 x 2
45/0402	MK 4 x 2
45/0403	MK 4 x 3
45/0504	MK 5 x 4



# Hole Saws

## Bi-Metal Hole Saws, 8% HSS-CO

M42 / 4-6 tpi, white



Art. No.	width (mm)	Art. No.	width (mm)	Art. No.	width (mm)	Art. No.	width (mm)	Art. No.	width (mm)
CT 14	14	CT 32	32	CT 52	52	CT 76	76	CT 121	121
CT 16	16	CT 33	33	CT 54	54	CT 79	79	CT 127	127
CT 17	17	CT 35	35	CT 57	57	CT 83	83	CT 133	133
CT 19	19	CT 37	37	CT 58	58	CT 86	86	CT 140	140
CT 20	20	CT 38	38	CT 59	59	CT 89	89	CT 146	146
CT 21	21	CT 40	40	CT 60	60	CT 92	92	CT 152	152
CT 22	22	CT 41	41	CT 63	63	CT 95	95	CT 160	160
CT 23	23	CT 43	43	CT 64	64	CT 98	98	CT 168	168
CT 24	24	CT 44	44	CT 65	65	CT 102	102	CT 177	177
CT 25	25	CT 46	46	CT 67	67	CT 105	105	CT 200	200
CT 27	27	CT 48	48	CT 68	68	CT 108	108	CT 210	210
CT 29	29	CT 50	50	CT 70	70	CT 111	111		
CT 30	30	CT 51	51	CT 73	73	CT 114	114		

### Arbors for Hole Saws

- Art. No. **A1/8,5** 14 - 30 mm A1/8,5
- Art. No. **A2/11** 14 - 30 mm A2/11
- Art. No. **A3/8,5** 32 - 210 mm A3/8,5
- Art. No. **A4/11** 32 - 210 mm A4/11

### Arbors for Hole Saws

- Art. No. **A5/11** 32 - 210 mm A5/11
- Art. No. **A7SDS** 14 - 30 mm A7 SDS
- Art. No. **A8SDS** 32 - 210 mm A8 SDS



### Replacement Drills

Art. No.	dia Ø (mm)	length (mm)	suitable for
B1	6,35	83	A1, A2, A3, A4, A5, A7, A8
B2	6,35	105	A10, multicut holesaw with A1, A2, A3, A4, A5, A7, A8





## Files

### KISTENMACHER brand Engineer File Sets,

second cut No. 2, in PVC wallet,  
with soft PVC 2-component handle - black/blue,  
5 pcs/set, **for metal working**

Art. No. **A918002-M2KT150** file length **150 mm**

Art. No. **A918002-M2KT200** file length **200 mm**

Art. No. **A918002-M2KT250** file length **250 mm**

consisting of:

- flat
- half round
- three square
- square
- round



### KISTENMACHER brand Rasp Sets,

second cut No. 2, in PVC wallet,  
with soft PVC 2-component handle - black/blue  
5 pcs/set, **for wood working**

Art. No. **A918002-W2KT150** file length **150 mm**

Art. No. **A918002-W2KT200** file length **200 mm**

Art. No. **A918002-W2KT250** file length **250 mm**

consisting of:

- flat
- half round
- three square
- square
- round



### Needle File Sets

in PVC wallet, 6pcs set

Art. No. **983142001** file length **140 mm**

Art. No. **983162001** file length **160 mm**

Art. No. **983182001** file length **180 mm**

consisting of:

- flat hand
- flat hand 2 flat edges
- half round
- round
- square
- three square



other sets and versions available upon request

# Files

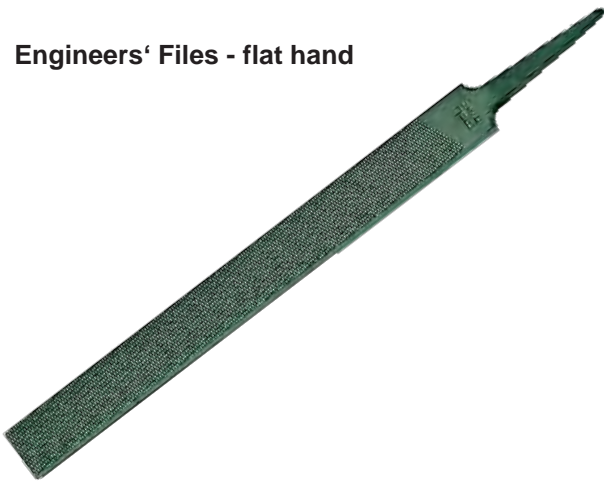
**Engineers' Files - flat hand**

Art. No. bastard type	Art. No. second cut	Art. No. smooth cut	size (mm - inch)	Ø (mm)
900100101	900100201	900100301	100 - 4"	12 x 3
---	900120201	---	125 - 5"	13 x 3
900150101	900150201	900150301	150 - 6"	15 x 4
900200101	900200201	900200301	200 - 8"	20 x 5
900250101	900250201	900250301	250 - 10"	25 x 6
900300101	900300201	---	300 - 12"	30 x 7
900350101	900350201	---	350 - 14"	35 x 8

**Engineers' Files - flat file - 2 flat edges**

Art. No. bastard type	Art. No. second cut	Art. No. smooth cut	size (mm - inch)	Ø (mm)
---	906100201	---	100 - 4"	12 x 3
906120101	906120201	---	125 - 5"	13 x 3
906150101	906150201	---	150 - 6"	15 x 4
906200101	906200201	---	200 - 8"	20 x 5
906250101	906250201	---	250 - 10"	25 x 6
906300101	---	---	300 - 12"	30 x 7

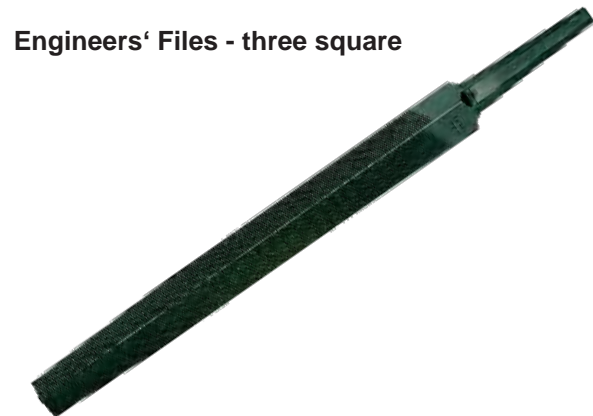
**Engineers' Files - three square**

Art. No. bastard type	Art. No. second cut	Art. No. smooth cut	size (mm - inch)	Ø (mm)
912100101	912100201	912100301	100 - 4"	8
---	912120201	---	125 - 5"	10
912150101	912150201	912150301	150 - 6"	11
912200101	912200201	912200301	200 - 8"	15
912250101	912250201	912250301	250 - 10"	19
912300101	912300201	912300301	300 - 12"	21
912350101	---	---	350 - 14"	24

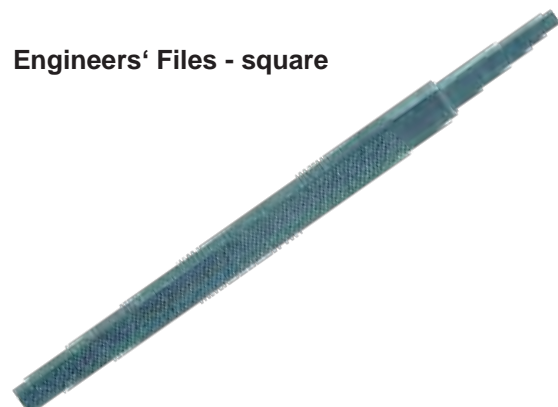
**Engineers' Files - square**

Art. No. bastard type	Art. No. second cut	Art. No. smooth cut	size (mm - inch)	Ø (mm)
913100101	913100201	913100301	100 - 4"	5
913120101	913120201	---	125 - 5"	5
913150101	913150201	913150301	150 - 6"	6
913200101	913200201	913200301	200 - 8"	8
913250101	913250201	913250301	250 - 10"	10
913300101	913300201	913300301	300 - 12"	12

# Files



## Engineers' Files - half round



Art. No. bastard type	Art. No. second cut	Art. No. smooth cut	size (mm - inch)	Ø (mm)
910100101	910100201	910100301	100 - 4"	11 x 3.5
910120101	910120201	---	125 - 5"	14 x 4
910150101	910150201	910150301	150 - 6"	16 x 4.5
910200101	910200201	910200301	200 - 8"	21 x 6
910250101	910250201	910250301	250 - 10"	25 x 7
910300101	910300201	---	300 - 12"	30 x 8.5
910350101	910350201	---	350 - 14"	35 x 10

## Engineers' Files - round



Art. No. bastard type	Art. No. second cut	Art. No. smooth cut	size (mm - inch)	Ø (mm)
914100101	914100201	914100301	100 - 4"	8
914120101	914120201	---	125 - 5"	10
914150101	914150201	914150301	150 - 6"	11
914200101	914200201	914200301	200 - 8"	15
914250101	914250201	914250301	250 - 10"	19
914300101	914300201	---	300 - 12"	21

## Car Body File Holders

with adjustable aluminium handle  
embossed with „Made in Germany“  
length: 355 mm

Art. No. **2160002**



## Car Body File Blades

curved tooth

length: 350 mm, cross section 36 x 5.5 mm

Art. No. **G052301350** coarse cut  
Art. No. **G052302350** medium cut  
Art. No. **G052303350** fine cut



## Pliers

### KISTENMACHER brand End Cutting Nippers

for steel wire, with polished head and red PVC coated handles



Art. No.	length (mm)
39/160 A3-P KI	160
39/180 A3-P KI	180
39/200 A3-P KI	200

### Heavy-Duty End Cutting Nippers

with polished head and red PVC coated handles

**VBW**   
The world of pliers



Art. No.	length (mm)
584 605	160
584 615	200

### Tower Pincers

black laquered, polished head



Art. No.	length (mm)	handle design
510 105	224	PVC coated handles
510 110	250	PVC coated handles
510 115	280	PVC coated handles
510 120	315	PVC coated handles
510 005	224	without handle coating
510 010	250	without handle coating
510 015	280	without handle coating
510 020	315	without handle coating

### Waterpump Pliers

- red laquered, polished  
- black polished



Art. No.	length (mm)	handle design
966 005	175	without handle coating
966 010	240	without handle coating
966 015	300	without handle coating
966 165	177	PVC coated handles
966 166	242	PVC coated handles
966 167	302	PVC coated handles

## Pliers

### Combination Pliers

polished head

**VBW**   
 The world of pliers



Art. No.	length (mm)	handle design
545 305	160	ergonomic 2-component handles
545 310	180	ergonomic 2-component handles
545 315	200	ergonomic 2-component handles
545 605	160	dip coated handles
545 610	180	dip coated handles
545 615	200	dip coated handles

### Side Cutters

polished head



Art. No.	length (mm)	handle design
587 215	140	ergonomic 2-component handles
587 220	160	ergonomic 2-component handles
587 225	180	ergonomic 2-component handles
587 605	125	dip coated handles
587 610	140	dip coated handles
587 615	160	dip coated handles
587 620	180	dip coated handles

### Long Nose Pliers

telephone engineer's pliers

polished head



Art. No.	length (mm)	handle design
524 202	140	ergonomic 2-component handles
524 203	160	ergonomic 2-component handles
524 205	200	ergonomic 2-component handles
524 602	140	dip coated handles
524 603	160	dip coated handles
524 605	200	dip coated handles

### 45° Long Nose Pliers

polished head



Art. No.	length (mm)	handle design
526 005	160	ergonomic 2-component handles
526 010	200	ergonomic 2-component handles
526 600	160	dip coated handles
526 605	200	dip coated handles

### Wire Strippers

polished head



Art. No.	length (mm)	handle design
543 205	160	ergonomic 2-component handles
543 305	160	dip coated handles

## Circlip Pliers



**VBW**   
The world of pliers

### Circlip Pliers for External Circlips

polished head - straight jaws

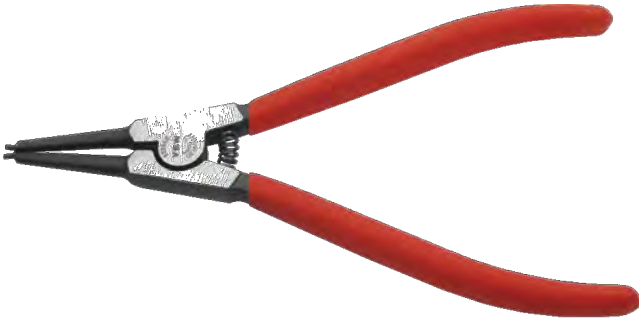

Art. No.	length (mm)	type	handle design
533 640	140	A0	dip coated handles
533 645	140	A1	dip coated handles
533 650	180	A2	dip coated handles
533 655	225	A3	dip coated handles
533 660	325	A4	dip coated handles

### Circlip Pliers for External Circlips

polished head - bent jaws 90°



Art. No.	length (mm)	type	handle design
534 105	125	A01	dip coated handles
534 110	125	A11	dip coated handles
534 115	170	A21	dip coated handles
534 120	200	A31	dip coated handles
534 125	290	A41	dip coated handles

### Circlip Pliers for Inside Circlips

polished head - straight jaws

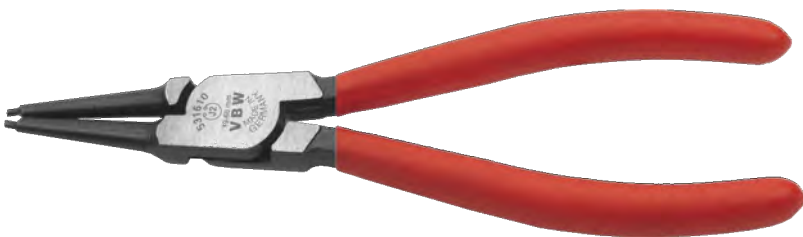

Art. No.	length (mm)	type	handle design
531 600	140	J0	dip coated handles
531 605	140	J1	dip coated handles
531 610	180	J2	dip coated handles
531 615	225	J3	dip coated handles
531 620	320	J4	dip coated handles

### Circlip Pliers for Inside Circlips

polished head - bent jaws 90°

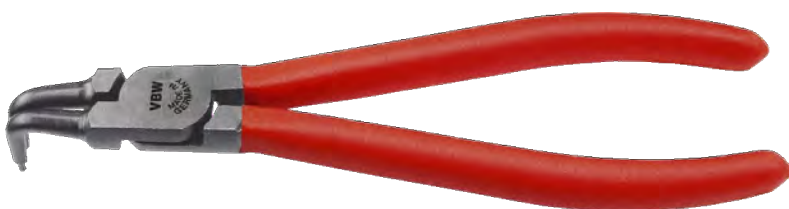

Art. No.	length (mm)	type	handle design
532 105	125	J01	dip coated handles
532 110	125	J11	dip coated handles
532 115	170	J21	dip coated handles
532 120	200	J31	dip coated handles
532 125	290	J41	dip coated handles

## Pliers

### KISTENMACHER brand Combination Pliers

with blue plastic coated heavy duty handles and anti slip guard



Art. No.	length (mm)	description
11-22-160	160	polished head
11-22-180	180	polished head
11-22-200	200	polished head
11-32-160	160	chrome plated head
11-32-180	180	chrome plated head
11-32-200	200	chrome plated head

### KISTENMACHER brand Side Cutters

with blue plastic coated heavy duty handles and anti slip guard



Art. No.	length (mm)	description
20-22-160	160	polished head
20-22-180	180	polished head
20-32-160	160	chrome plated head
20-32-180	180	chrome plated head

### KISTENMACHER brand Long Nose Pliers

straight, with blue plastic coated heavy duty handles and anti slip guard



Art. No.	length (mm)	description
12-22-160	160	polished head
12-22-200	200	polished head
12-32-160	160	chrome plated head
12-32-200	200	chrome plated head

### KISTENMACHER brand Long Nose Pliers

45° bent, with blue plastic coated heavy duty handles and anti slip guard



Art. No.	length (mm)	description
13-22-160	160	polished head
13-22-200	200	polished head
13-32-160	160	chrome plated head
13-32-200	200	chrome plated head



### KISTENMACHER brand Circlip Pliers

external, straight, chrome plated, leaf spring

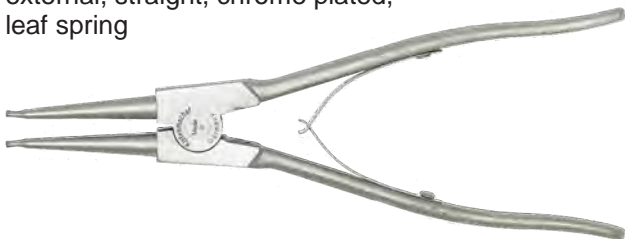

Art. No.	length (mm)	description
300-30-130	130	A0
301-30-130	130	A1
302-30-180	180	A2
303-30-220	220	A3
304-30-320	320	A4

### KISTENMACHER brand Circlip Pliers

external, bent, chrome plated, leaf spring



Art. No.	length (mm)	description
310-30-130	130	A01
311-30-130	130	A11
312-30-175	175	A21
313-30-210	210	A31
314-30-310	310	A41





## Circlip Pliers, Bolt Cutter and Pipe Grip Wrenches

### KISTENMACHER brand Circlip Pliers

internal, straight, chrome plated



Art. No.	length (mm)	description
320-30-130	130	J0
321-30-130	130	J1
322-30-180	180	J2
323-30-220	220	J3
324-30-320	320	J4



### KISTENMACHER brand Circlip Pliers

internal, bent, chrome plated

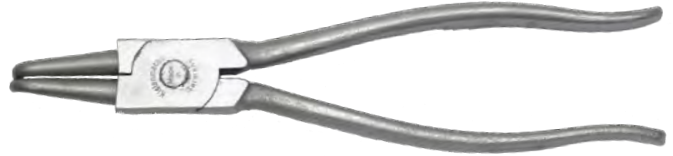

Art. No.	length (mm)	description
330-30-130	130	J01
331-30-130	130	J11
332-30-180	175	J21
333-30-220	210	J31
334-30-320	310	J41



### Adjustable Pipe Grip Wrenches with Nut

straight version



Art. No.	length (mm)	length (inch)	weight (g)
136/7	178	7	300
136/9	228	9	531
136/10.5	281	11	851
136/12	315	12	1038
136/14	360	14	1656



### Adjustable Pipe Grip Wrenches with Nut



Art. No.	length (mm)	weight (g)
257/175	175	300
257/240	240	500
257/270	270	700
257/300	300	900



### KISTENMACHER brand Bolt Cutters DIN ISO 5743

- exchangeable cutter head
- easy double cam bolt adjustment, starting from Art. No. 97-146 on

Art. No.	length (mm)	length (inch)
97-133	330	13"
97-140	400	16"
97-146	460	18"
97-162	620	24"
97-178	780	30"
97-190	900	35"





## Hydraulic Crimping and Cutting Tools



### Hydraulic Crimping Tool Set with Foot Pump in blue metal case

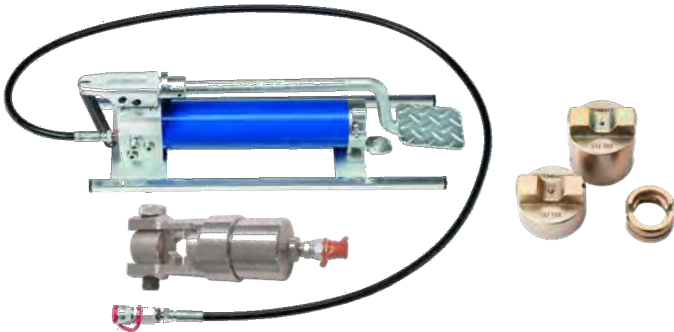

Art. No.	crimping force	crimping range
SET PK 250 KI	250 kN	16 - 630 mm <sup>2</sup>
SET PK 450 KI	450 kN	95 - 1.000 mm <sup>2</sup>

foot-operated double piston pump, 700 bar, with automatic change-over and pressure relief valve and coupling, complete with 2 mtr. mounted high pressure hose, with rotating nickel plated crimping head in blue metal transport case

with yellow chromitized CU-hexagonal crimping dies, sets consisting of the following dies:

#### SET PK 250 (14 pieces)

16, 25, 35, 50, 70, 95, 120, 150, 185, 240, 300, 400, 500, 630 mm<sup>2</sup>

#### SET PK 450 (11 pieces)

95, 120, 150, 185, 240, 300, 400, 500, 635, 800, 1.000 mm<sup>2</sup>  
resp. 11 pcs - PK450)

### Hydraulic Cable Cutting Tool Set with Foot Pump in blue metal case

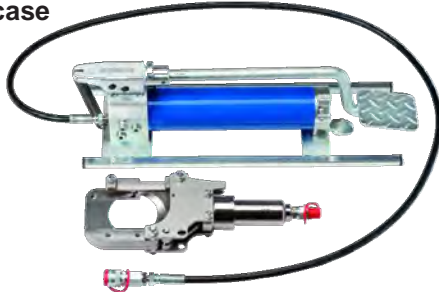

Art. No.	cutting force	cutting range
SET SK 85 KI	70 kN	85 mm
SET SK 120 KI	100 kN	120 mm

foot-operated double piston pump, 700 bar, with automatic change-over and pressure relief valve and coupling, complete with 2 mtr. mounted high pressure hose, with rotating cutting head in blue metal transport case

suitable for aluminium and copper cable

### Hydraulic Foot Pump



Art. No.	pressure	hose length
FP 700	700 Bar	2 meters

foot-operated double piston pump with automatic change-over and pressure relief valve and coupling, complete with 2 mtr. mounted high pressure hose

### Hydraulic Cable Cutter Head

chrome-plated rotating cutting head with double piston pump and automatic safety relief valve

suitable for power copper and aluminium cables



Art. No.	cutting force	cutting range
SK 85 KI	70 kN	85 mm

### Hydraulic Cable Cutter Head

black lacquered rotating cutting head with double piston pump and automatic safety relief valve



Art. No.	cutting force	cutting range	suitable cables
SK 120 KI	100 kN	120 mm	CU + AL
SK 120 ST-KI	100 kN	120 mm	Armoured Copper

### Hydraulic Cable Cutter Head

black lacquered rotating cutting head with double piston pump and automatic safety relief valve

suitable for **armoured copper**, aluminium, ACSR cables and solid steel bars up to 16 mm



Art. No.	cutting force	cutting range
SK 45 KI	70 kN	45 mm

### Hydraulic Cable Cutter Head - Shear Type - open

with quick coupling suitable for foot pump / electro pump up to 700bar, suitable for power copper and aluminium cables



Art. No.	cutting force	cutting range
SK 120 O	100 kN	120 mm

# Hydraulic Crimping and Cutting Tool Sets



## Hydraulic Crimping Tool Set

hand-operated, with rotating C-compression head, double piston pump and automatic safety relief valve, in blue metal carrying case

complete with yellow chromated CU-hexagonal crimping dies (13 pcs)



Art. No.	weight (g)	length (mm)	crimping force	crimping range
SET PK 130 KI	7.800	695	130 kN	10 - 400 mm <sup>2</sup>



## Hydraulic Crimping Tool Set

hand-operated, with rotating C-compression head, double piston pump and automatic safety relief valve, in blue metal carrying case

complete with yellow chromated CU-hexagonal crimping dies (13 pcs)

with extra large opening of 42mm head, suitable as well for C- and H-Clamps



Art. No.	weight (g)	length (mm)	crimping force	crimping range
SET PK 130 KI / 42	8.200	705	130 kN	10 - 400 mm <sup>2</sup>



## Hydraulic Crimping Tool Set

hand-operated, with rotating round-compression head, double piston pump and automatic safety relief valve, in blue metal carrying case

complete with yellow chromated CU-hexagonal crimping dies (12 pcs)



Art. No.	weight (g)	length (mm)	crimping force	crimping range
SET HP60/22 KI	3.500	450	60 kN	10-300 mm <sup>2</sup>



## Hydraulic Cable Cutter

hand-operated, with rotating cutting head, double piston pump and automatic safety relief valve, in blue metal carrying case

suitable for copper and aluminium cables.



Art. No.	weight (g)	length (mm)	cutting force	cutting range	suitable cables
HS 45 KI	7.500	680	60 kN	max. 45 mm <sup>2</sup>	Armoured Copper
HS 50 KI	6.500	680	60 kN	max. 50 mm <sup>2</sup>	CU + AL
HS 85 KI	12.000	700	70 kN	max. 85 mm <sup>2</sup>	CU + AL



## Battery Operated Hydraulic Tools

### Hydraulic Crimping Tool Set



- with open head

battery powered with memory card, packed in blue metal carrying case

- rotating crimping head
- yellow chromitized, CU-hexagonal crimping dies
- spare battery, battery charger, software and USB data cable



### Hydraulic Crimping Tool Set



- with C head (29 mm)

Art. No.	crimping force	crimping range	number of dies
APE 6-22 KI	60 kN	10 - 300 mm <sup>2</sup>	12

Art. No.	crimping force	crimping range	number of dies
APE 13C KI	130 kN	10 - 400 mm <sup>2</sup>	13

### Hydraulic Crimping Tool Set



- rotating crimping head
- yellow chromitized, CU-hexagonal crimping dies
- spare battery, battery charger, software and USB data cable

- with open head

Both battery powered with memory card, packed in blue metal carrying case



### Hydraulic Cutting Tool Set

- rotating cutting head
- yellow chromitized, CU-hexagonal crimping dies
- spare battery, battery charger, software and USB data cable



Art. No.	crimping force	crimping range	number of dies
APEM 5-5	50 kN	- 10 - 150 mm <sup>2</sup> (Aluminium)	9
		- 10 - 185 mm <sup>2</sup> (Copper)	10
		- 10 - 240 mm <sup>2</sup> (Standard)	11

Art. No.	cutting force	cutting range
ASE 85 KI	70 kN	max. 85 mm <sup>2</sup>

### Electrohydraulic Pump for use with mains 220 - 240V



For use with mains 220 - 240V, with digital pressure gauge, equipped with 2 mtr hydraulic hose and quick couplings, suitable to connect most common crimping and cutting devices.

*Longer hydraulic hoses and bigger tank volume available on request*

- max. pressure (HD) 700 bar
- min. pressure (ND) 60 bar
- haul capacity (HD) 0,34 l / min
- haul capacity (ND) 0,80 l / min
- motor capacity 0,37 kw
- engine rpm 1360
- tank volume 2,0 ltr
- weight 18,0 kgs
- voltage 220 - 240 V / 50 / 60 Hz
- noise level 75 dB A

Art. No.	operating pressure	motor capacity
AKPE2 KI	700 bar	0,37 kw

### Battery Operated Hydraulic Drive Unit

Equipped with 1,50 mtr. Hydraulic high pressure hose and quick couplings, suitable to connect most common crimping and cutting devices, total weight 4,90 kgs only

Including:

- remote control and strap
- bag
- read-out option of the machine status
- failure analysis
- li-ion battery 3.000 mA / 18V



Art. No.	operating pressure
AKPE1 KI	700 bar

## Mechanical Cable Cutters

### Mechanical Cable Cutter for CU and AL Cables

PVC coated handles with blue/yellow insulation, suitable for CU and AL Cables.

not suitable for cutting steel or steel wire



Art. No.	cutting range	length
K 100	max. Ø 14 mm	280 mm

### Mechanical Cable Cutter for CU and AL Cables

PVC coated handles with blue/yellow insulation, suitable for CU and AL Cables.

not suitable for cutting steel or steel wire



Art. No.	cutting range	length
K 101/1	max. Ø 26 mm	570 mm

### Mechanical Cable Cutter for CU and AL Cables

PVC coated handles with blue/yellow insulation, suitable for CU and AL Cables.

not suitable for cutting steel or steel wire



Art. No.	cutting range	length
K 101/2	max. Ø 38 mm	930 mm

### Mechanical Cable Cutter for CU and AL Cables

PVC coated handles with blue/yellow insulation, suitable for CU and AL Cables.

not suitable for cutting steel or steel wire



Art. No.	cutting range	length
K 130	max. Ø 30 mm	570 mm
K 150	max. Ø 50 mm	710 mm

### Mechanical Cable Cutter for CU and AL Cables

PVC coated handles with blue insulation, suitable for CU and AL Cables.

not suitable for cutting steel or steel wire



Art. No.	cross ref.	cutting range	length
SH 620	K 106/2	max. Ø 62 mm	297 mm

### Mechanical Cable Cutter for CU and AL Cables

PVC coated handles with blue/yellow insulation, suitable for CU and AL Cables.

not suitable for cutting steel or steel wire

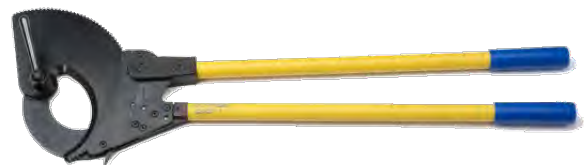

Art. No.	cross ref.	cutting range	length
SH 1000	K 104/1	max. Ø 100 mm	870 mm

### Mechanical Cable Cutter for CU and AL Cables

PVC coated handles with blue insulation, suitable for CU and AL Cables.

not suitable for cutting steel or steel wire



Art. No.	cross ref.	cutting range	length
SH 340	K 106/1	max. Ø 34 mm	261 mm

### Mechanical Cable Cutter for CU and AL Cables

PVC coated handles with blue insulation, suitable for CU and AL Cables.

not suitable for cutting steel or steel wire



Art. No.	cross ref.	cutting range	length
SHF340		max. Ø 34 mm	298 mm

## Mechanical Crimping Tools

### Syncro Crimping Tools with two-component handle Hexagonal crimping



Art. No.	crimping range	length
K 05	6 - 50 mm <sup>2</sup>	390 mm
K 06	10 - 120 mm <sup>2</sup>	650-750 mm - telescopic handle
K 09	25 - 150 mm <sup>2</sup>	650-750 mm - telescopic handle

mechanical crimping tool for tubular cable lugs and connectors, standard type, synchronised die selection when in the open position, cross-section display on marked adjusting wheel, extremely lightweight and rigid

### Mechanical Crimping Tools with revolving dies Indent crimping



Art. No.	crimping range	length
K 5	6 - 50 mm <sup>2</sup>	600 mm
K 6	50 - 120 mm <sup>2</sup>	970 mm
K 7	120 - 240 mm <sup>2</sup>	975 mm
K 07	185 - 400 mm <sup>2</sup>	975 mm
K 8	35 - 95 mm <sup>2</sup>	975 mm

mechanical crimping tool for tubular cable lugs and connectors, standard type, with revolving dies, PVC coated handles, with blue/yellow insulation

### Crimping Hand Tool

suitable for red/blue/yellow insulated DIN cable lugs, pin cable lugs, tabs and receptacles, circular connectors and receptacles butt and parallel connectors



Art. No.	cross ref.	red	blue	yellow
CK 90-44	CK 90	0,5 - 1,0 mm <sup>2</sup>	1,5 - 2,5 mm <sup>2</sup>	4,0 - 6,0 mm <sup>2</sup>

### Crimping Hand Tool

with exchangeable crimping Die Sets



Art. No.	cross ref.	range	application
CK 100 SET 44	CK 100-44	0,5 - 6,0 mm <sup>2</sup>	red/blue/yellow cable lugs/ pin cable lugs, tabs, receptacles, circular connectors, butt parallel connectors
CK 100 SET 65	CK 100-65	0,5 - 10,0 mm <sup>2</sup>	flat push-on receptacles and tabs without insulation
CK 100 SET AE21	CK 100-AE21	0,14 - 10,0 mm <sup>2</sup>	wire end ferrules with and without insulation sleeve

### Hydraulic Punching Tools

punches accurate slugs nearly free of burrs, easy single handed using with small effort



LS8



LS6



LS8-SET

Art. No.	cross ref.	punching capacity	punching force	handle
LS8	50-600	steel plates up to max. 3 mm	80 kN	straight
LS6	50-099	steel plates up to max. 3 mm	60 kN	angled

Art. No.	cross ref.	cutting edges and matrix	components
LS8-SET	50-608	Ø 16,5mm (M16), 20,5mm (M20), 25,5mm (M25), 32,5 mm (M32)	3 elastic inserts, 1 sleeve, 1 adapter, 1 rod, 1 plastic case with insert

## Knockout Punching Tool

### ALFRA - Tricut® Knockout Punching tool with 3-fold split

complete with ball bearing screw  
ball bearings encapsulated in orange aluminium rings,  
individually packed in plastic box

Art. No.	hole dia. (inch)
01692	1/2"
01698	3/4"
01711	1"
01718	1 1/4"
01723	1 1/2"
01732	2"



### ALFRA - Hole Puncher MonoCut®

complete with ball bearing screw  
ball bearings encapsulated in orange aluminium rings,  
individually packed in plastic box

Art. No.	hole dia. (inch)
01046	1/2"
01070	3/4"
01118	1"
01162	1 1/4"
01170	1 1/2"
01206	2"



### ALFRA - Tricut® Knockout Punching tool sets

complete with ball bearing screw  
ball bearings encapsulated in orange aluminium rings,  
all sets are supplied in heavy-duty practical plastic cases

Art. No.	pcs per set	inch/ mm	sizes
01757	7	mm	M16 - M20 - M25 - M32 - M40 - M50 - M60
01760	6	inch	1/2" - 3/4" - 1" - 1 1/4" - 1 1/2" - 2"
01761	6	inch	1/2" - 3/4" - 1" - 1 1/4" - 1 1/2" - M 50
01762	5	mm	M16 - M20 - M25 - M32 - M40



### ALFRA - Hole Puncher MonoCut® sets

complete with ball bearing screw  
ball bearings encapsulated in orange aluminium rings,  
all sets are supplied in heavy-duty practical plastic cases

Art. No.	pcs per set	inch/ mm	sizes
01291	7	mm	M16 - M20 - M25 - M32 - M40 - M50 - M60
01459	6	inch	1/2" - 3/4" - 1" - 1 1/4" - 1 1/2" - 2"
01463	6	inch	1/2" - 3/4" - 1" - 1 1/4" - 1 1/2" - M 50
01290	5	mm	M16 - M20 - M25 - M32 - M40



# Punching Technology

## Hydraulic Punch Driver

- extremely versatile and easy-to-use hole punching tool thanks to 360° rotatable punching head, punching range up to 3,5 mm mild steel
- lightweight aluminium construction for easy operation and effortless portability
- accessories: punches (type D): 22,5 - 22,3 - 34,6 - 43,2 - 49,6 - 61,5 mm
- 7/16" x 3/4" draw stud, 3/4" x 3/4" draw stud
- spacer, sealing kit



Art. No.	punching force	stroke	weight
EGK WK-8AL	70 KN	25 mm	2,1 kg
EGK WK-12AL	120 KN	27 mm	3,0 kg

## Manual Knock Out Punch Kit 1/2" - 1 1/4". - EGK MPS 1/2-1.1/4:

description	hole size (actual)	
	Ø inch	Ø mm
1/2" conduit size punch and die	7/8"	22,50
3/4" conduit size punch and die	1,115"	28,30
1" conduit size punch and die	1,362"	34,60
1"-1/4" conduit size punch and die	1,701"	43,20
3/8" , 24UN draw stud with bearing		
3/4" , 16UN draw stud with bearing		



## Manual Knock Out Punch Kit 1 1/2" - 2" - EGK MPS 1.1/2-2:

description	hole size (actual)	
	Ø inch	Ø mm
1 - 1/2" conduit size punch and die	1-15/16"	49,60
2" conduit size punch and die	2-3/8"	61,50



## Snips

### ERDI brand Shape Cutting Snips

for short, straight and outline cuts, edges with micro-serrations for slip-proof working

Art. No.	length (mm)	length (inch)	weight (g)	cutting
D27-R	260	10 1/4"	480	right
D27-L	260	10 1/4"	480	left



### ERDI brand Shape and Straight Cutting Snips

for long continuous, straight and curved cuts, edges with micro-serrations for slip-proof working

Art. No.	length (mm)	length (inch)	weight (g)	cutting
D27A-R	260	10 1/4"	520	right
D27A-L	260	10 1/4"	520	left



### ERDI brand Shape and Straight Cutting Snips

for long continuous, straight cuts, edges with micro-serrations for slip-proof working

Art. No.	length (mm)	length (inch)	weight (g)	cutting
D27B-R	260	10 1/4"	520	right
D27B-L	260	10 1/4"	520	left



### Figure Snips

with 2-component handle, light model left cutting

Art. No.	length (mm)	length (inch)
212700-250	250	10



### Figure Snips

with 2-component handle, light model right cutting

Art. No.	length (mm)	length (inch)
212750-250	250	10

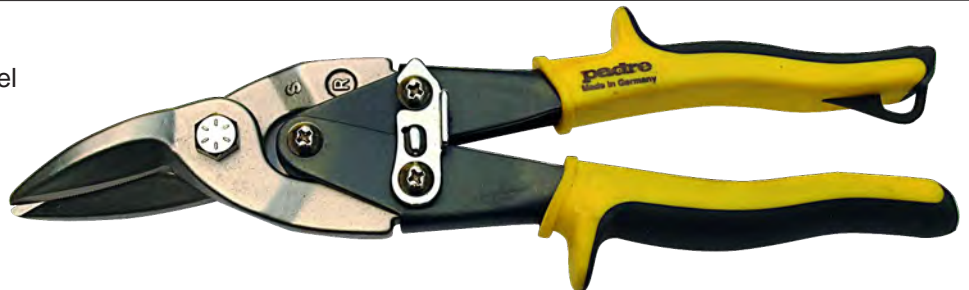

### Figure Snips

with 2-component handle, light model straight cutting

Art. No.	length (mm)	length (inch)
212800-250	250	10

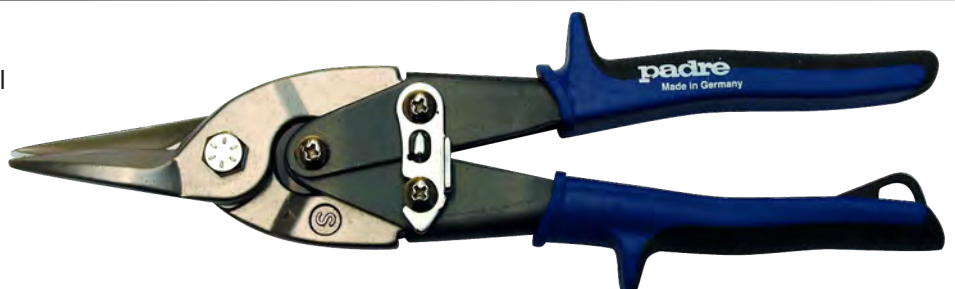



## Snips



### American Pattern Snips

for straight cuts - only left cutting available,  
with blue PVC coated handles

Art. No.	length (mm)	length (inch)	weight (g)	PU
218006-175	175	7	210	6
218006-200	200	8	240	6
218006-250	250	10	440	6
218006-300	300	12	660	6
218006-350	350	14	800	6



### English Pattern Snips - Gilbow

with lacquered handles

Art. No.	length (mm)	length (inch)	weight (g)	PU
216960-200	200	8	200	6
216960-250	250	10	400	6
216960-300	300	12	600	6
216960-350	350	14	850	6



### Snip English Pattern

with long spring and plastic strap

Art. No.	length (mm)	length (inch)	weight (g)	PU
216900-200	200	8	270	6
216900-250	250	10	380	6
216900-300	300	12	560	6



### Multi-Purpose Cutters

- stainless steel blades
- edges with serrations for slip-proof working
- on carded hang pack



Art. No.	length (mm)	length (inch)	blade length (mm)	blade length (inch)	weight (g)	PU
D47	140	5 1/2"	31	1 1/4"	80	15
D48	190	7 1/2"	42	1 5/8"	120	10

## Snips an Nibbler

### Berlin Pattern Snips

for straight cuts - only right cuts available,  
with yellow plastic coated handles  
available with and without spring

Art. No.	cutting	length (mm)	length (inch)
214000-250		250	10
214010-250	w. spring	250	10
214000-275		275	11
214010-275	w. spring	275	11



### Hole Cutting Shears

with yellow plastic coated handles,  
available with and without spring



Art. No.	cutting	length (mm)	length (inch)
213000-225	right	225	9
213000-250	right	250	10
213000-275	right	275	11
213000-300	right	300	12
213010-225	right w. spring	225	9
213010-250	right w. spring	250	10
213010-275	right w. spring	275	11
213010-300	right w. spring	300	12

Art. No.	cutting	length (mm)	length (inch)
213200-250	left	250	10
213200-275	left	275	11
213200-300	left	300	12
213210-250	left w. spring	250	10
213210-275	left w. spring	275	11
213210-300	left w. spring	300	12

### Band Iron Snip

right cutting

Art. No.	length (mm - inch)	weight (g)	PU
215000	250 - 10	350	5



### Sheet Metal Nibbler

right cutting

Art. No.	length (mm - inch)	weight (g)	PU
212900	250 - 10	450	1



## Pipe Cutting & Bending



### Tube Cutter for Copper Tubes

precision machining provides quickest and smoothest action, extremely robust and compact - easy to use

Art. No.		description
63170	32 mm	for copper tubes
63119	42 mm	for copper tubes



### Pipe Cutter for Steel Tubes

with one cutting wheel and two guide rollers

Art. No.	pipe Ø	Weight (kg)	description
63172	1/8" - 2"	2,5	for steel pipes
63175	2" - 4"	8	for steel pipes
63101	spare wheel		for steel pipes 63172
63185	spare wheel		for steel pipes 63175



### Hydraulic Pipe Bending Tools

the innovative 2-velo valve system enables automatically fast pre-loading together with a soft bending without any need to change pistons

Art. No.	pipe Ø	load capacity
60015	1/4" - 2"	up to 10 tons
60016	1/4" - 3"	up to 13 tons



### VIRAX brand Plastic Tube Cutter up to 42 mm

- cuts: PVC, PE, PER, PEX, flexible plastic pipes, sprinkler hoses, irrigation hoses, multilayer
- locking catch: keeps the lower handle closed, easy storage.
- no risk of injury
- ergonomomy: the lower handle's special shape is suitable for all hand sizes.
- soft Touch® handle: non-slip grip for firm control



Art. No.	cutting Ø (mm)	length (mm)	height (mm)	weight (g)
214026	28			170
215032	32	198	90	195
215042	42	238	113	530



## Garden Shears



### Classic Lopping Shears

cutting head with anti-adhesive blades for clean cut, chrome plated, all screw joints are fixed with self locking nut, high-grade aluminium tubes and handles with hand guard



Art. No.	length (mm)	weight (g)
4195	460	835
4200	600	955
4204	750	1105

### Gardening Shears

forged metal body - chromium plated cutting head

Art. No.	length (mm)	weight (g)
1760	220	245



### Gardening Shears

forged metal body - frost protective coating in handle area - ring lock

Art. No.	length (mm)	weight (g)
1700	220	290



### Gardening Shears

forged metal body - shear blade and hook replaceable, shockabsorber, hook with deep sap groove, blade with wire notch, intermediate locking position, straight cutting head

Art. No.	length (mm)	weight (g)
1110	220	250



### Sheep Shears

round spring, straight hot drop forged model

Art. No.	length (mm)	cutting length (mm)	weight (g)
2711	310	140	250
2712	330	155	285



**BERGER**  
made to cut. SINCE 1919

## Axes & Hatchets



### Hatchets (German Type)

in accordance to German DIN standards, safety proofed,  
with ash wooden handle, red-dipped grip



Art. No.	weight	handle
	(g)	length (mm)
11306	600	360
11307	700	360
11308	800	380
11310	1000	400



### Axes (German Type)

in accordance to German DIN standards, safety proofed,  
with ash wooden handle, red-dipped grip



Art. No.	weight	handle
	(g)	length (mm)
10110	1000	600
10112	1250	700
10114	1400	700
10116	1600	800
10117	1750	900
10120	2000	900
10122	2250	900



### Hatchets (American Type)

yankee version with ash wooden handle,  
red-dipped grip



Art. No.	weight		handle
	(g)	(lb)	length (mm)
11426	600	1 1/4	380
11427	700	1 1/2	380
11428	800	1 3/4	380
11429	900	2	380



### Hooked Crafting Pocket Knife

handle made of wood, blade of stainless steel  
available in blister packing or PVC bag



Art. No.	weight	blade length	handle	length
	(g)	(mm)	length (mm)	(mm)
C330	120	80	115	195



## Hammers

### Rivetting Hammers DIN 1041

german pattern, ash wood handle



Art. No.	weight
0000101-0050	50
0000101-0100	100
0000101-0150	150
0000101-0200	200
0000101-0250	250
0000101-0300	300
0000101-0350	350
0000101-0400	400

Art. No.	weight (g)
0000101-0500	500
0000101-0600	600
0000101-0800	800
0000101-1000	1,000
0000101-1250	1,250
0000101-1500	1,500
0000101-2000	2,000

### Copper Hammers

sledge hammer shape with, ash wood handle



Art. No.	weight (g)
0033001-0250	250
0033001-0500	500
0033001-0750	750
0033001-1000	1000
0033001-1500	1500
0033001-2000	2000

### Sledge Hammers DIN 1042

with cross peen, straight hickory handle



Art. No.	weight (g)	handle length (mm)
0000202-03	3,000	600
0000202-04	4,000	700
0000202-05	5,000	800
0000202-06	6,000	800
0000202-08	8,000	900

### Mining Sledges DIN 6476

double faced, ash wood handle



Art. No.	weight (g)	handle length (mm)
0000401-1000	1,000	260
0000401-1250	1,250	270
0000401-1500	1,500	280
0000401-2000	2,000	300
0000402-03	3,000	600
0000401-04	4,000	700
0000402-05	5,000	800
0000402-06	6,000	900
0000402-08	8,000	900

# Hammers



## Engineers Hammers

with cross peen, english pattern, ash wood handle



Art. No.	weight
0001001-0100	1/4
0001001-0225	1/2
0001001-0340	3/4
0001001-0450	1
0001001-0500	1 1/8
0001001-0600	1 1/4
0001001-0700	1 1/2
0001001-0800	1 3/4
0001001-0900	2

## Claw Hammers

english pattern, with socket, black finish, ash wood handle



Art. No.	weight (g)	length (mm)
0003021	350	310

## Claw Hammers

american pattern, polished finish, with tubular steel shaft and special grip

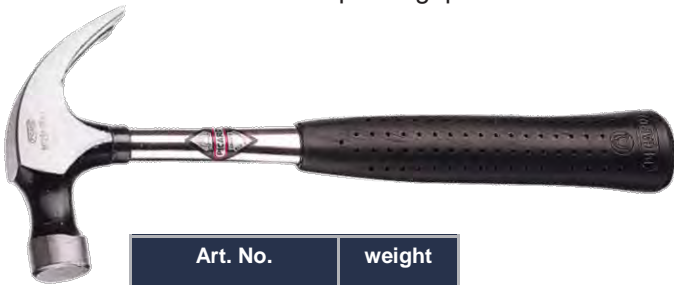

Art. No.	weight
0029100-13	13
0029100-16	16

## Carpenters' Roofing Hammers DIN 7239

black, with tubular steel shaft and black grip (rough surface)

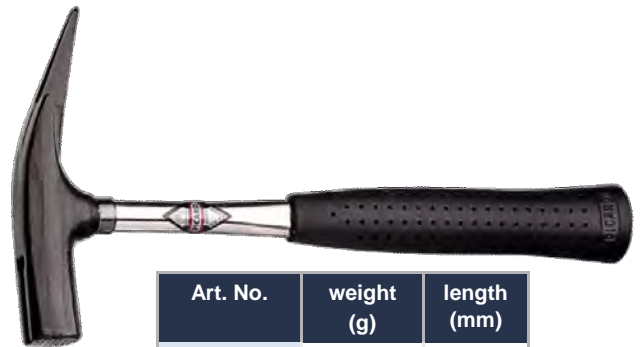

Art. No.	weight (g)	length (mm)
0060010	600	320

## Wooden Mallets

head white beech wood material without metal coat, handle and wedge glued, ash wood handle



Art. No.	head size (mm)
602	40 x 80
603	50 x 100
604	60 x 120
605	70 x 140
606	80 x 160
607	90 x 180

## Wooden Mallets

head white beech wood material, with metal coat, handle and wedge glued, ash wood handle

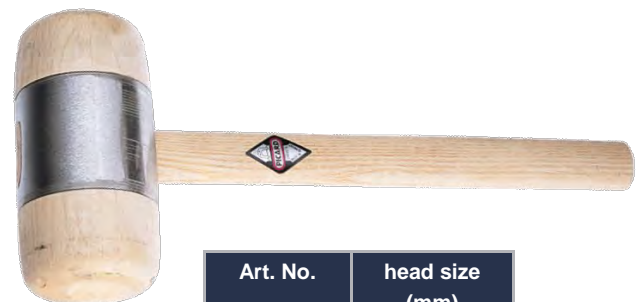

Art. No.	head size (mm)
0032001-1	50 x 100
0032001-2	60 x 120
0032001-3	70 x 140
0032001-4	80 x 160

# Handles for Hammers, Pickaxes, Files and Shovels



## Hammer Handles made of ash wood



Art. No.	suitable for (g)	handle length (mm)	handle Ø (mm)
111.26	100	260	17 x 10
111.28	200	280	19 x 11
111.30	300	300	21 x 12
111.32	500	320	26 x 15
111.35	800	350	29 x 17
111.36	1.000	360	31 x 18
111.38	1.500	380	33 x 20
111.40	2.000	400	37 x 22
111.45	2.500	450	42 x 24
111.50	3.000	500	42 x 24

## Mining Sledge Hammer Handles made of ash wood



Art. No.	suitable for (g)	handle length (mm)	handle Ø (mm)
115.28	1.000	280	33 x 20
115.30	1.500	300	37 x 22
115.35	2.000	350	37 x 22

## Sledge Hammer Handles made of ash wood



Art. No.	suitable for (g)	handle length (mm)	handle Ø (mm)
111.60	3,000	600	42 x 24
111.80	5,000	800	48 x 28
111.90	12,000	900	59 x 35

## Pickaxe Handles made of beech wood



Art. No.	shape	handle length (mm)	handle Ø (mm)
44PN	oval	95	42 x 24
55PR	round	95	55
60PR	round	95	60

## File Handles made of beech wood



Art. No.	handle length (mm)	handle Ø (mm)
201.80	80	18
201.90	90	20
201.100	100	22
201.110	110	25
201.120	120	28
201.130	130	30
201.140	140	32
201.150	150	34
201.160	160	36

## Shovel Handles made of beech wood



Art. No.	handle length	Ø (mm)
130SH	130 cm	15 x 6

## Metal Wedges



Art. No.	size	head size (mm)
3927.00	00	13
3927.0	0	16
3927.1	1	20
3927.2	2	23
3927.3	3	26
3927.4	4	29
3927.5	5	33
3927.55	5.5	40
3927.6	6	50

## Pinching Bars with hexagonal shaft, made of special steel



Art. No.	handle length (mm)	shaft Ø (mm)
9840186	400	18
9850186	500	18
9860186	600	18
9880186	800	18
98d1186	1000	18



## Trowels

### Classic Smoothing Trowels

classic style, aluminium column  
beechwood handle in red or blue

Art. No.	size (mm)
014.280	280 x 130 x 0,7



### Notched Smoothing Trowels

classic style, aluminium column  
beechwood handle in red or blue

Art. No.	size (mm)	notches
014.284	280 x 130 x 0,7	4 x 4
014.286	280 x 130 x 0,7	6 x 6
014.288	280 x 130 x 0,7	8 x 8
014.281	280 x 130 x 0,7	10 x 10

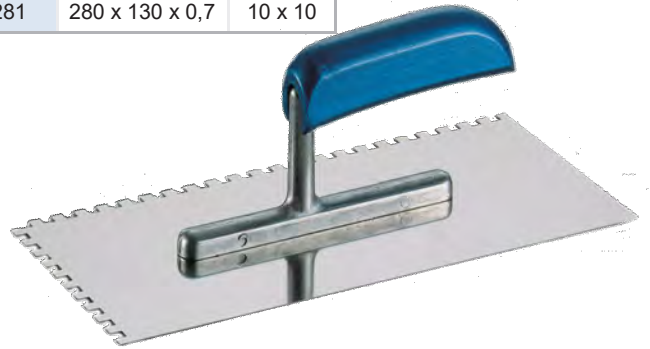

### Lebanese Style Smoothing Trowels

with two steel columns and varnished wooden handle

Art. No.	size (mm)
281028	280 x 130 x 0,7



### Modern Smoothing Trowels

modern style, aluminium column, multicomponent  
handle in red/black  
straight finish or with teeth

Art. No.	size (mm)	notches
014.280.2K	280 x 130 x 0,7	---
014.284.2K	280 x 130 x 0,7	4 x 4
014.286.2K	280 x 130 x 0,7	6 x 6
014.288.2K	280 x 130 x 0,7	8 x 8
014.281.2K	280 x 130 x 0,7	10 x 10



### Belgium Style Smoothing Trowels

half round nose, with two aluminium columns and  
varnished wooden handle

Art. No.	size (mm)
220128	280 x 110 x 85 x 0.7 mm
220028	280 x 110 x 85 x 1.1 mm



### Flooring Trowels

pointed, with two aluminium columns and closed  
wooden handle in red or blue

Art. No.	size (mm)
400645	450 x 90 x 70 x 1.1 mm
400650	500 x 90 x 70 x 1.1 mm
400660	600 x 90 x 70 x 1.1 mm
400670	700 x 90 x 70 x 1.1 mm

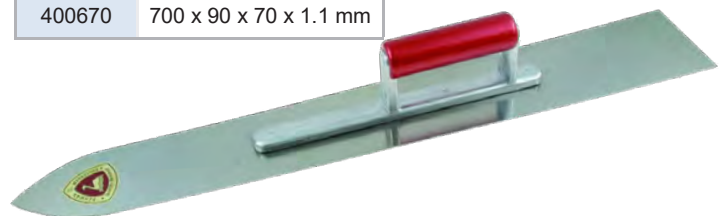

## Trowels

### Plastic Finishing Trowels

classic style

Art. No.	size (mm)
201428	140 x 280
201832	180 x 320
202036	200 x 360

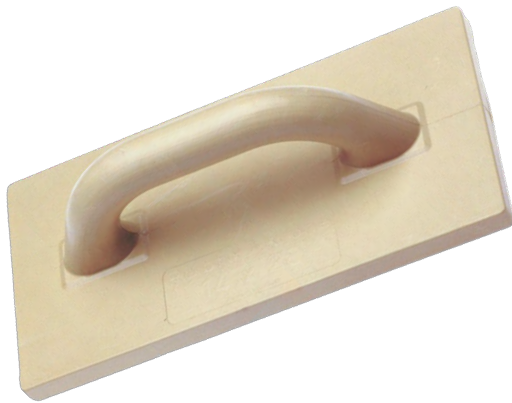

### Plastic Finishing Trowels

classic style

Art. No.	size (mm)
76785 1428	140 x 280
76785 1832	180 x 320
76785 2036	200 x 360



### Plastic Finishing Trowels

with „HYDRO“ sponge support

Art. No.	size (mm)
481428	140 x 280

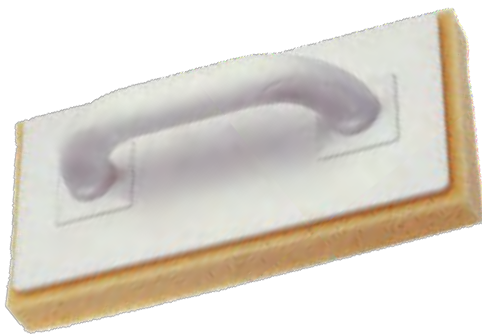

### Plastic Finishing Trowels

with rubber sponge - 20 mm - rough finish

Art. No.	size (mm)
421428	140 x 280



### Plastic Smoothing Trowels

with blue coloured hollow PVC handle

Art. No.	size (mm)
641428	140 x 280

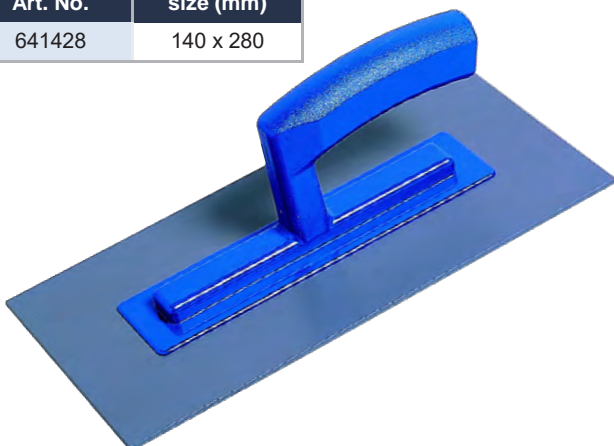

### Darby Plastic Finishing Trowels

extra long

Art. No.	size (mm)
200080	120 x 800
200100	120 x 1000
200120	120 x 1200

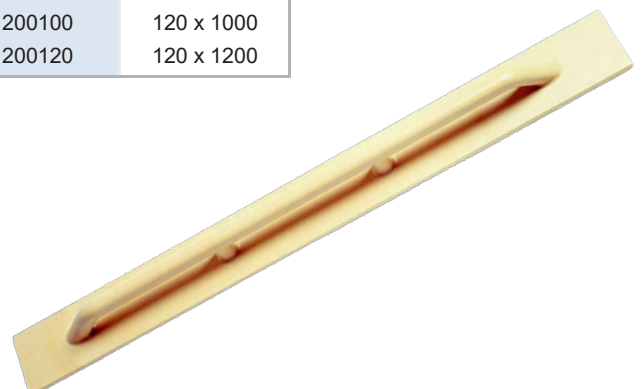



## Scrapers & Spatulas



### Rubber Scrapers

for jointing seams - with beechwood handle

Art. No.	size (mm)
501502	200
501504	250
501503	300



### Wall Scrapers - „JUCO“ brand

made of polished spring steel with beechwood handle

Art. No.	size (mm)
810/200	200
810/250	250

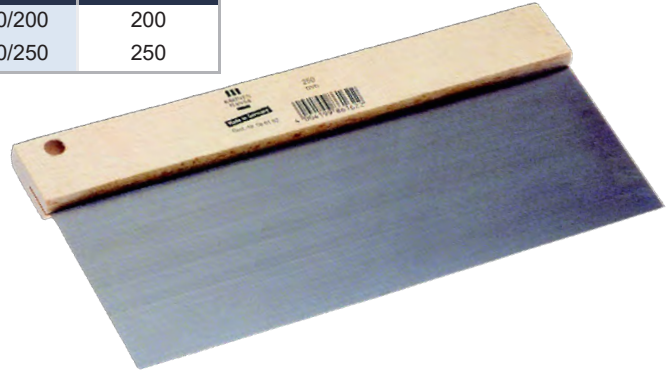

### Notched Wall Scrapers

made of polished spring steel with beechwood handle

Art. No.	size (mm)	notches
086028	180	6 x 6
086029	250	6 x 6

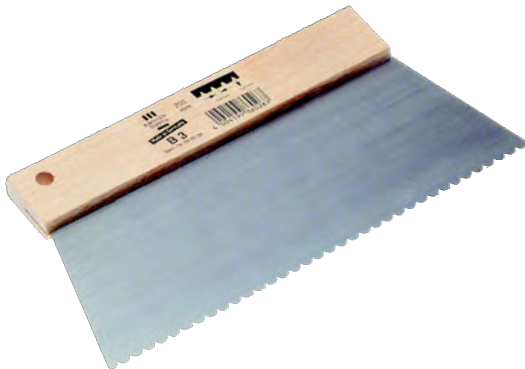

### Japan Scraper Sets

steel blade with plastic back  
cons. of 4 pcs/set: 50/80/100/120 mm

Art. No.
85-620-000



### Spatula, stainless steel

with plywood handle

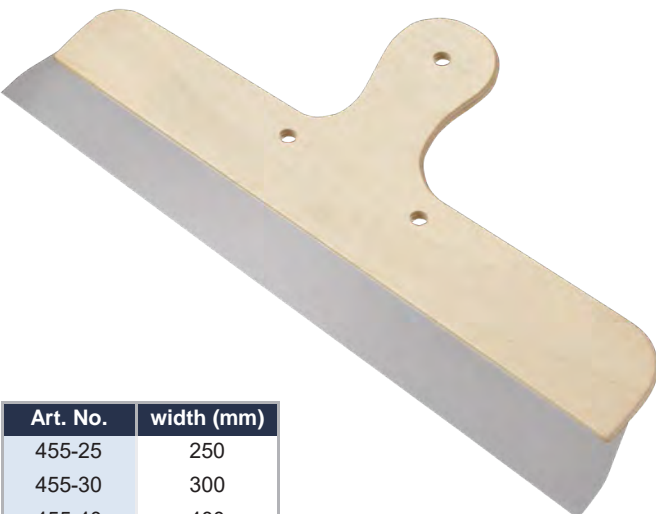

Art. No.	width (mm)
455-25	250
455-30	300
455-40	400
455-50	500
455-60	600

### Spatula, stainless steel

with wooden handle



Art. No.	width (mm)
991-00	30
992-00	40
993-00	50
994-00	60
995-00	80
996-00	100
997-00	120
998-00	150



## Paint Rollers

### Refills for Radiator Paint Rollers - 10 cm

white with broad yellow line, glued, polyamide fabric,  
10 pcs. in a plastic box, then 840 pcs in a carton



Art. No. **K50.320**  
Art. No. **K50.320H** incl. roller frame (Art. No. 87416 - 42 cm)

### Refills for Paint Rollers - 11 cm

10 pcs. in a plastic box with label, CFC free foam, glued



Art. No. **K50.420** white colour, straight, fine quality

### Refills for Paint Rollers - 11 cm

10 pcs. in a plastic box with label, CFC free foam, glued



Art. No. **K50.427** white colour, round face, fine quality

### Refills for Paint Rollers - 11 cm

10 pcs. in a plastic box with label, CFC free foam, glued



Art. No. **K50.440** yellow colour, straight, for rustic wall structures with plasters or fillings

### Refills for Radiator Paint Rollers - VESTAN 10 cm

white for 6 mm / roller size 10 cm  
10 pcs. in a plastic box, then 500 pcs in a carton



### Roller Frames

handle: ROTERGO green, embossed with „Made in Germany“, 20 pcs each in a carton

Art. No.	length (cm)	width (cm)
87216	27	10-12
87416	42	10-12
87616	66	10-12
87816	80	10-12
80516	30	25-27



### Spike Rollers - 25 cm

spike-length 12 mm  
to drive out air inclusions in polyester and epoxy resin coatings by rolling

Art. No. **27069** - Plastic spike

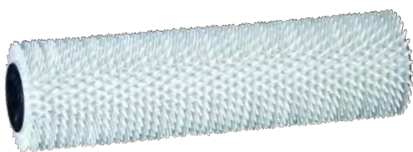

Art. No. **27068** - Metal spike

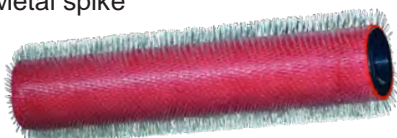

### Wallpaper Seam Rollers

complete with strong handle, 10 pcs each in a carton

Art. No. **24090** - 18 cm



Art. No. **61090** - 5 cm



## Brushes & Utility Knives

### Radiator Brushes

with light bristles and wooden handle (unlacquered)  
standard quality



Art. No.	size (mm)	size (inch)
435025-401	25	1.0"
435035-401	35	1.5"
435050-401	50	2.0"
435060-401	60	2.5"
435075-401	75	3.0"

### Ceiling Brushes - Quality DUHALON - Size No. 2

with black oval plastic body and black plastic handle with clip, pure white DUHALON bristles, length 82 mm, size 180 x 85 mm

Art. No.	pcs per carton
76232401029	12



### Utility Knives

with die-cast grip - hammer grey enamel  
incl. 5 straight blades (Art. No. 57E)

Art. No.
57

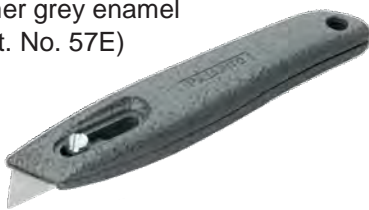

### Folding Utility Knives

with lever for safe locking of blades, allowing a quick and easy blade change. Soft plastic thumb pad allows maximum pressure, with safe storage of spare blades



Art. No.	overall length (mm - inch)	blade length (mm - inch)	kg	pcs per sales box
DBKPH-EU	160 - 6 1/4	28 - 1 1/8	0,18	12

### Ceiling Brushes - Size No. 1

with plastic handle and clip, wooden body, size 170 x 70 mm

with PVC bristles

Art. No.	pcs per carton
7515280000	12



with pure fibre bristles for Bitumen application

Art. No.	pcs per
7517000000	12



### Straight Blades

0,65 mm special hardened and polished steel packed in boxes of 12 pcs

Art. No.
57E



### Straight Blades

0,65 mm special hardened and polished steel - no deep-cut, packed in boxes of 12 pcs

Art. No.
57H



# Tile Cutting Machines with steel base plate



Art. No.	cutting length:	tile thickness	Ø (mm)
115	300 mm	10 mm	15 x 6



Art. No.	cutting length:	tile thickness	Ø (mm)
166	400 mm	15 mm	15 x 6



with angle adjustment

Art. No.	cutting length:	tile	Ø
153	470 mm	18 mm	22 x 6
154	600 mm	18 mm	22 x 6

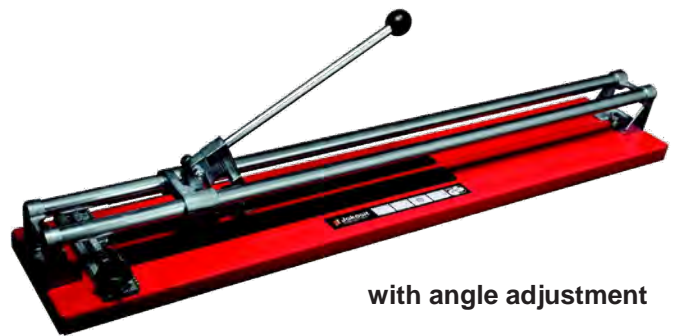

with angle adjustment

Art. No.	cutting length:	tile	Ø
158	800 mm	18 mm	22 x 6

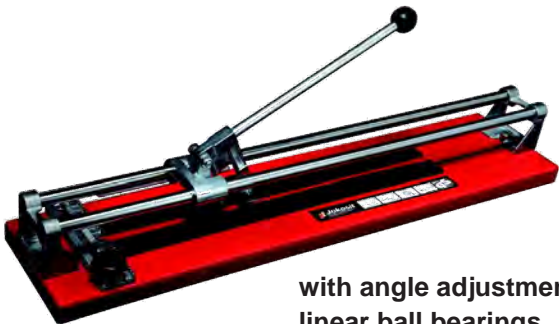

with angle adjustment and linear ball bearings

Art. No.	cutting length:	tile	Ø
163	470 mm	18 mm	22 x 6
164	600 mm	18 mm	22 x 6

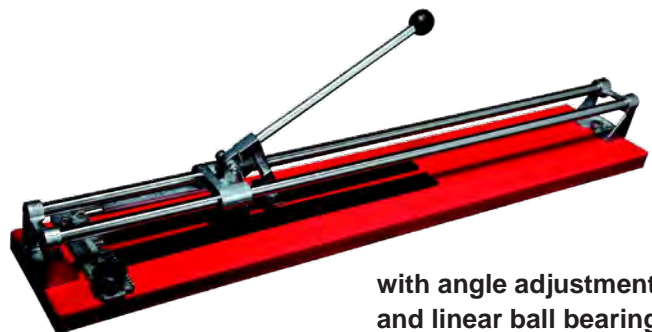

with angle adjustment and linear ball bearings

Art. No.	cutting length:	tile thickness	Ø (mm)
165	800 mm	18 mm	22 x 6

## Carbide Cutting Wheels, ground



Art. No.	Ø (mm)
053	22 x 6

Art. No.	Ø (mm)
054	15 x 6

## Carbide Tile-Hole Cutter

Art. No.	drilling range
600	30 - 80 mm



## Tile Spacer and Cork Pads

### Tile Spacers

in poly bag



Art. No. 250 pcs/bag	Art. No. 200 pcs/bag	Art. No. 100 pcs/bag	size (mm)
20250L	20200L	20100L	2 x 28
25250L	25200L	25100L	2.5 x 28
30250L	30200L	30100L	3 x 28
40250	40200	40100	4 x 22
50250	50200	50100	5 x 22
60250	60200	60100	6 x 24
---	80200	80100	8 x 30
---	---	10100	10 x 30

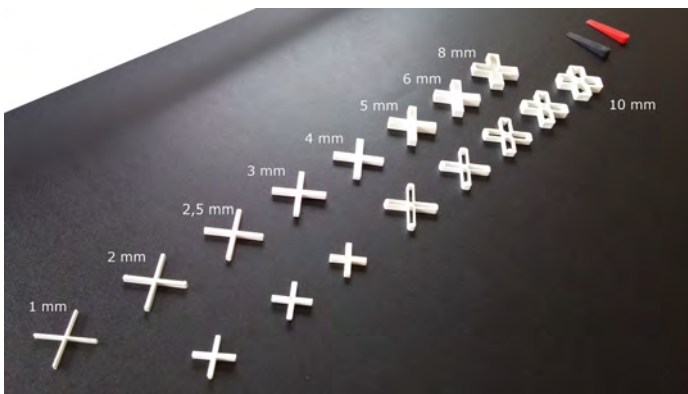

### Cork Inseal Pads

on roll with paper lay self-adhesive, cork stacking discs are ideal spacers for glass, plastics, wood and many other sensitive surfaces, simple to use as transport and storage protection, easy to remove again

**Art. No. L5507-2**

size 15 x 15

**thickness 6 mm**

60.000 pcs per carton

**Art. No. L5507-3**

size 18 x 18

**thickness 8 mm**

30.000 pcs per carton



### White Polyurethane Foam Tapes

fine open-cell, with brown PVC backing, not UV-resistant, highly compressible and very adaptable



Art. No. thickness 6 mm	size (mm)	length (mtr)	pcs/ carton
14003-03/12	10	12	25
14003-03/15	10	15	20
14003-03/19	10	19	16
14003-03/25	10	25	12
14003-03/30	10	30	10

Art. No. thickness 8 mm	size (mm)	length (mtr)	pcs/ carton
14003-03/15/8	7.5	12	25
14003-03/19/8	7.5	15	20
14003-03/25/8	7.5	19	16

Art. No. thickness 9 mm	size (mm)	length (mtr)	pcs/ carton
14003-03/9/9	7.5	12	25

Art. No. thickness 10 mm	size (mm)	length (mtr)	pcs/ carton
14003-03/19/10	7.5	12	25



## Glass Tools

### VERIBOR Suction Lifters blue line

the strong durability of aluminium combined with synthetic material is a trademark of this suction lifter

- suitable for all materials with flat and airtight surfaces such as glass, plastic, metal, coated wood and marble  
suction pad Ø: 120 mm



Art. No. 600.0BL



Art. No. 602.0BL

Art. No.	load cap.	cups
600.0BL	30 kg	1 cup - one hand
602.0BL	70 kg	2 cup - transverse handle
602.4BL	60 kg	2 cup - lengthwise handle
603.0BL	100 kg	3 cup



Art. No. 602.4BL



Art. No. 603.0BL

### VERIBOR Suction Lifters

traditional design of strong aluminium body

- suitable for all materials with flat and airtight surfaces such as glass, plastic, metal, coated wood and marble

Art. No.	load cap.	cups
600.0	30 kg	1 cup - one hand operation Ø 120 mm
602.4	60 kg	2 cup - lengthwise handle operation Ø 120 mm
603.0	100 kg	3 cup



Art. No. 600.0

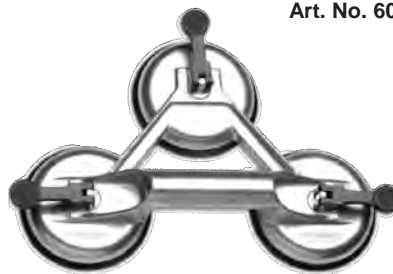

Art. No. 603.0



Art. No. 602.4

### VERIBOR Suction Lifters, plastic construction

- suitable for all materials with flat and airtight surfaces such as glass, plastic, metal, coated wood and marble  
suction pad Ø: 120 mm



Art. No. 600.1



Art. No. 602.1A

Art. No.	load cap.	cups
600.1	30 kg	1 cup
602.1A	60 kg	2 cup - lengthwise handle
602.2A	50 kg	2 cup



Art. No. 602.2A



## Glass Tools

### Glass Cutters SILBERSCHNITT

for glass thickness from 3 to 10 mm.  
6 cutting wheels made of alloyed steel and tempered by a patented method guarantee high cutting quality and long service life.  
Turrets and cutting heads are nickel plated.

Art. No.: 100.0



### Carbide Glass Cutters

especially suitable for thick and hard glass, wooden handle, replaceable, tempered turret with carbide wheel Ø 5 mm, especially selected carbide metal guarantees high wear-resistance

Art. No.: 400.0

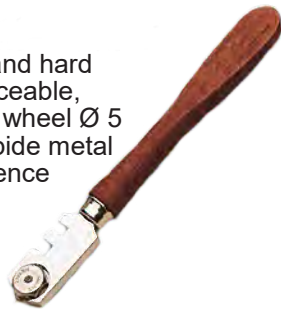

### Carbide Glass and Tile Cutters

cutting angle 135°, ergonomically shaped, plastic handle especially suitable to cut tiles requiring high cutting pressure, tempered turret with one carbide wheel 5 mm

Art. No.: 410.0



### JOBO Glass Cutters

6 cutting wheels made of special steel, round wooden handle, straight edge stand-off distance 2,5 mm

Art. No.: 320.0

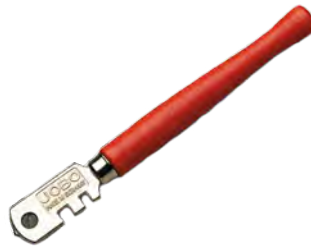

### Spare Turrets with 6 Steel Wheels

suitable for all SILBERSCHNITT glass and circle cutters 501.0 and 511.0 - 516.0

Art. No.: 101.0



### Spare Wheels

stainless steel, especially tempered suitable for all SILBERSCHNITT glass and circle cutters

Art. No.: 102.0 in practical dispenser of 10 doz  
Art. No.: 102.1 in dozens on a needle in plastic bag



### Oil Glass Cutters

original TOPLIFE quality with extended service life, handle with finger grip

Art. No.: 5000.0 brass, wide head  
Art. No.: 5000.1 brass, narrow head  
Art. No.: 3001.0 plastic, wide head  
Art. No.: 3001.1 plastic, narrow head



Art. No. 5000.0



Art. No. 5000.1



Art. No. 3001.0  
Art. No. 3001.1

## Glass Tools

### Cutting Heads - Spare

for all SILBERSCHNITT oil glass, wide or narrow plate, cutting angle 138°

- Art. No.: 4010.1** narrow cutting head  
**Art. No.: 5010.0** wide plate



4010.1



5010.0

### Circle Cutters with ball-bearing cutting head

trailing carbide wheel in TOPLIFE quality

- improved break quality even for small radii
- long service life
- less cutting pressure
- diameter, min. 72 mm
- cutting angle: 135°
- 2-6 mm glass thickness

- Art. No.: 511.5** diameter: 60 cm  
**Art. No.: 514.5** diameter: 120 cm  
**Art. No.: 516.5** diameter: 200 cm  
**Art. No.: 518.5** metal wheel holder spare head



### Circle Cutters with 6 steel wheels

- cutting angle: 130°
- wheels and turret can be easily exchanged
- 3-6 mm glassthickness

- Art. No.: 511.0** diameter: 60 cm  
**Art. No.: 514.0** diameter: 120 cm  
**Art. No.: 516.0** diameter: 200 cm  
**Art. No.: 518.0** spare cuttinghead



### Glass Breaking Pliers

ground head, plastic coated handle, lacquered finish

Art. No.	length	colour	jaw width
50 081 18	180 mm	black	24 mm
50 080 20	200 mm	black	24 mm
50 081 20	200 mm	blue	20 mm
50 082 20	200 mm	blue	20 mm - bent jaws
50 082 18	180 mm	black	14 mm - drop jaws



50 081 18  
50 080 20



50 081 20



50 082 20



50 082 18

### Glass Nippers, lacquered

with carbide jaws, easy nipping of small glass parts, ideal for working on edges, plastic coated handles

- Art. No.: 50 095 20**  
 200 mm lacquered black

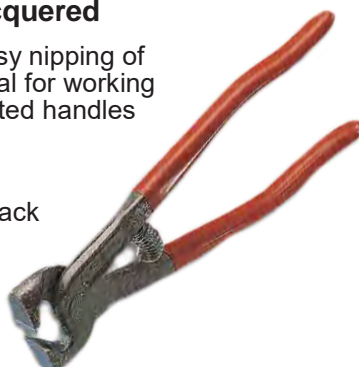

### Putty Knives

brown polished wooden handle, blade: 26 mm wide



- Art. No.: 51 621 00** highly polished continuous blade, blade length 110 mm  
**Art. No.: 51 622 00** highly polished blade, spear point blade length 90 mm



## Glass Tools

### JOBO Carpet Grippers

- aluminium, for carpeted double floors
- 2 cup - lengthwise handle

Art. No.: 619.9



### Glass Carrying Device Tragboy

suitable for transporting all kinds of sheet materials, 80 kg carrying capacity per pair

- the load is held firmly between two non-slip, rubber lined clamps
- the heavier the load, the stronger the clamping pressure
- opening range max. 25 mm

Art. No.: 50 001 01



### Verifix UVA-Star 500, 1110, 1410

for stress-free curing of bended edges, 230 Volts, white light

Art. No.: 55 003 80 , working length 500 mm, 18W

Art. No.: 55 003 85 , working length 1100 mm, 36W

Art. No.: 55 003 90 , working length 1410 mm, 58W

Product Highlights:

- state-of-the-art technology, new design
- energy and time saving
- easy to use
- particularly suitable for glass / glass edge bonding



### UV Curing Adhesives - Verifix B 665-0

this UV adhesive is crystal-clear and thin-bodies (low viscosity) - it displays very good capillary properties allowing it to be applied from the outside and penetrating into the gap of pre-assembled parts by itself - not waterproof over time

Art. No.: 52 093 24 content 1000g

Art. No.: 52 093 21 content 250g

Art. No.: 52 093 00 content 100g

Art. No.: 52 093 27 content 20g



### Glass Carrying Gloves PowerGrab KEVLAR® KEV4

KEVLAR® cut resistant gloves with open-pored MicroFinish® latex coating to provide optimum grip

breathable material on back of hand  
also available with extended wrist protection  
tested per DIN EN 388 CAT II

- Art. No.: 50 175 11 (M)
- Art. No.: 50 175 10 (L)
- Art. No.: 50 175 09 (XL)
- Art. No.: 50 175 08 (XXL)



### Glass Carrying Gloves

seamless cotton/polyester fabric, palm and fingertips with blue latex coating

good protection against mechanical risks  
tested per DIN EN 388 CAT II

- Art. No.: 50 175 19 (M)
- Art. No.: 50 175 18 (L)
- Art. No.: 50 175 17 (XL)
- Art. No.: 50 175 16 (XXL)



# L-Squares



## L-Squares without brace

made of high-quality material with two pegs made of blue plastic allowing the glass edge to be fully visible when positioned

Art. No.	length (cm)	width (cm)	colour
029.00	30	17	without pegs - black
029.5	30	17	black
030.5	50	27	grey
031.5	60	27	grey
032.5	80	37	grey
033.5	105	37	grey
034.5	135	47	grey
035.5	150	47	grey
036.5	175	47	grey



## L-Squares with brace - black

made from one piece of high-quality material

Art. No.	length (cm)	width (cm)
031.1	60	30
032.1	80	34
033.1	105	40
034.1	135	45
035.1	150	45
036.1	175	50
037.1	205	60
038.1	250	70



## Joiner's Square

with mitre, with two graduations

### light version

steel blade 30 mm

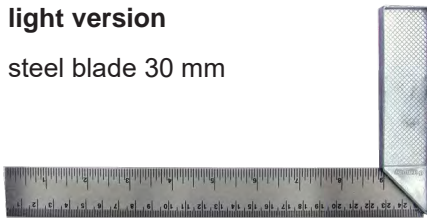

Art. No.	length (mm)
1020150	150
1020200	200
1020250	250
1020300	300
1020350	350
1020400	400

### heavy version

steel blade 35 mm

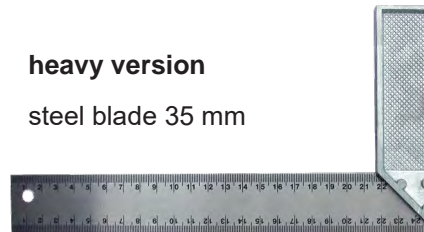

Art. No.	length (mm)
1110150	150
1110200	200
1110250	250
1110300	300
1110350	350
1110400	400

## Steel Square

carbon steel, zinc plated

### without back

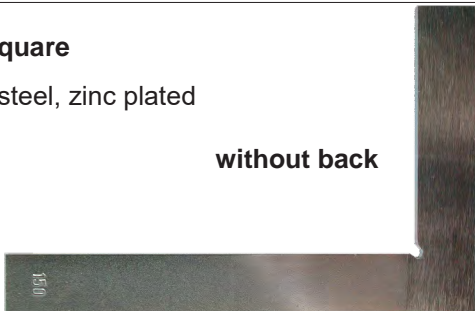

Art. No. w/o back	blade width (mm)	size (mm)
1200100	20	100 x 70
1200150	20	150 x 100
1200200	20	200 x 130
1200250	25	250 x 160
1200300	25	300 x 180
1200400	25 / 30	400 x 230
1200500	25 / 30	500 x 280
1200600	30	600 x 330
1200800	30	800 x 430
1201000	30	1000 x 500

### with back

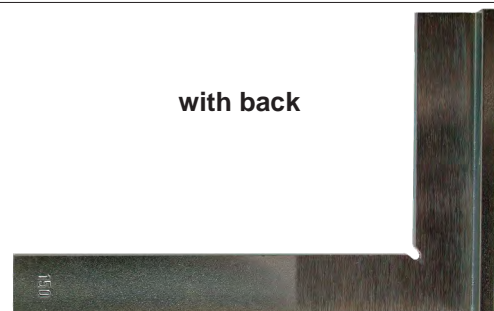

Art. No. with back	blade width (mm)	size (mm)
1300100	20	100 x 70
1300150	20	150 x 100
1300200	20	200 x 130
1300250	25	250 x 160
1300300	25	300 x 180
1300400	25	400 x 230
1300500	25	500 x 280
1300600	30	600 x 330
1300800	30	800 x 430
1301000	30	1000 x 500

## Squares



### Try Square - Powder Coated

made of hardened spring steel, 40 x 1.2 mm, with mm-graduation.  
support blade made of black anodised aluminium profile, L-form 40 x 14 mm.  
powder coated in yellow (RAL 1021).

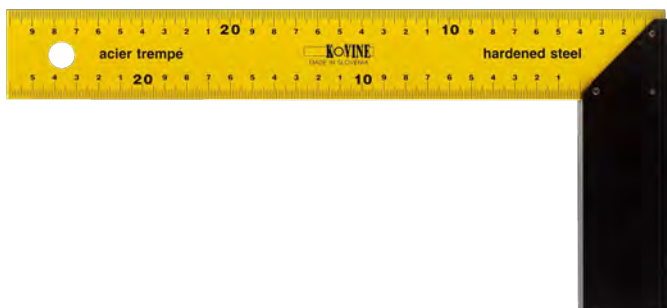

Art. No.	dimensions (mm)
KMI200	200 x 125
KMI250	250 x 135
KMI300	300 x 135
KMI350	350 x 190
KMI400	400 x 190
KMI500	500 x 210

### Carpenter's Square - Powder Coated

made of hardened spring steel, 35 x 1.5 mm, with mm-graduation.  
powder coated in yellow (RAL 1021).

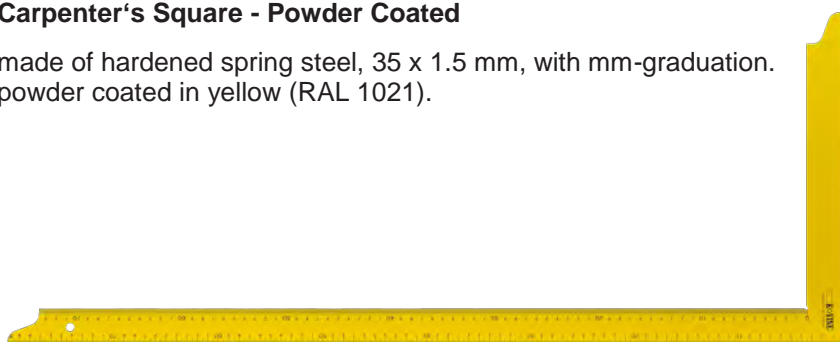

Art. No.	dimensions (mm)
KTB500	500 x 250
KTB600	600 x 280
KTB700	700 x 300
KTB800	800 x 320
KTB900	900 x 340
KTB1000	1000 x 360

### Carpenter's Square - Powder Coated

made of hardened spring steel, 35 x 1.5 mm, with mm-graduation.  
zinc coated.

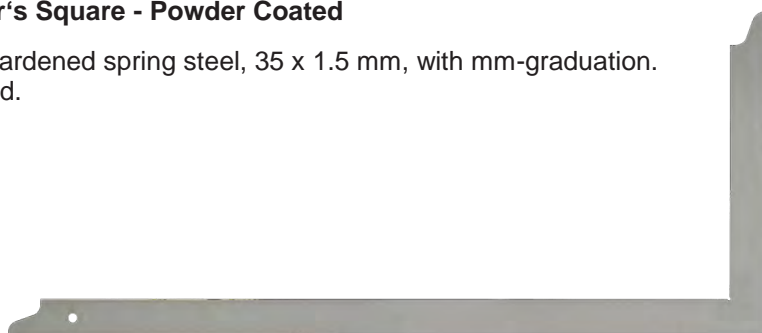

Art. No.	dimensions (mm)
KTC500	500 x 250
KTC600	600 x 280
KTC700	700 x 300
KTC800	800 x 320
KTC900	900 x 340
KTC1000	1000 x 360

### Try Square 45° - Powder Coated

made of hardened spring steel, 40 x 1.2 mm.  
support blade made of black anodised aluminium profile, L-form 40 x 1.4 mm.  
for measuring of angles 45° and 135°. Powder coated in yellow (RAL 1021).



Art. No.	length (mm)
KMS250	250



## Clamps & Joiner's Squares



### Joiner's Squares

with die-cast stock and mm-graduation,  
light execution,  
steel blade 32 mm - INOX blade 30 mm

Art. No.	length (mm)	Art. No. INOX	length (mm)	Material
123120	200	122120	200	stainless steel blade
123125	250	122125	250	stainless steel blade
123130	300	122130	300	stainless steel blade
123135	350			
123140	400			

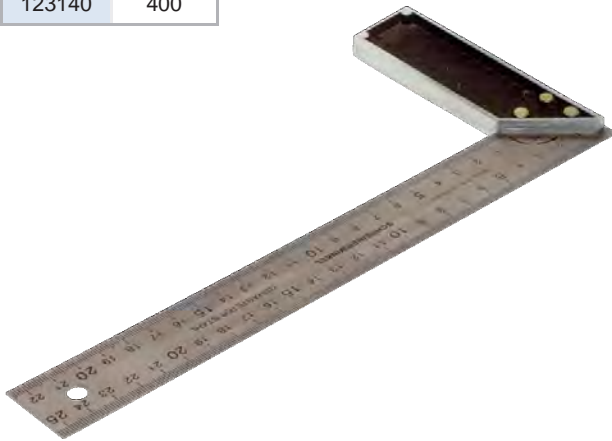

### Joiner's Squares

with beech wood stock, blue steel blade and  
mm-graduation  
blade 40 mm

Art. No.	length (mm)
102125	250
102130	300
102140	400

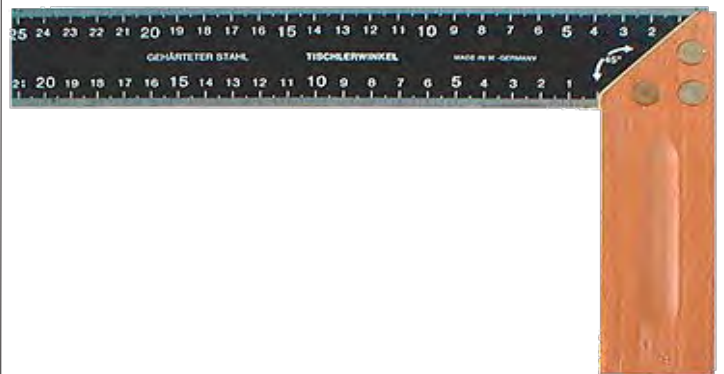

### BESSEY Door Clamps

with T-profile  
colour: black

Art. No. Type A	Art. No. Type B	length
TAN 80		800
	TB 100	1000
TAN 120	TB 120	1200
TAN 150	TB 150	1500
TAN 210	TB 210	2100
TAN 250	TB 250	2500

**A)** Sash clamp TAN with L-profile, 80 x 42 x 3.9 mm, easy adjustable jaws, with stopping bolt, Type TAN - force 24.000 N

**B)** Sash clamp TB with T-profile 40 x 40 x 5 mm with locking bolt, Type TB - force 14.000N

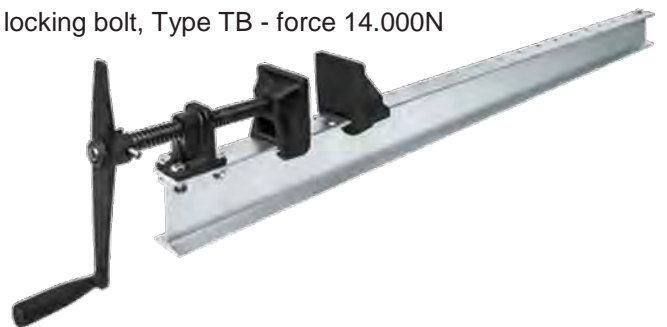

### KISTENMACHER brand C-Clamps

made of high grade, drop forged steel, galvanized  
with fine thread spindle

Art. No.	Clamping	throat
420-028	28	25
420-053	53	38
420-078	78	50
420-105	105	60
420-130	130	70
420-155	155	76
420-206	206	86



## F-Clamps



**KISTENMACHER brand cast iron F-Clamps,**  
galvanized grooved hollow section bar,  
black clamp,  
with red coloured wooden handle and protective caps

Art. No.	size (mm)	rail (mm)
21100	100x50	15x5
21101	120x60	22x6
21102	160x80	25x6
21103	200x100	30x8
21104	250x120	30x8
21105	300x140	35x9
21106	400x175	35x9
21199	400x120	35x11
21200	500x120	35x11
21201	600x120	35x11
21202	800x120	35x11
21203	1000x120	35x11
21204	1250x120	35x11
21205	1500x120	35x11
21206	2000x120	35x11
21207	2500x120	35x11
21208	3000x120	35x11



**KISTENMACHER brand cast iron F-Clamps,**  
galvanized grooved hollow section bar,  
silver galvanized clamp,  
with red coloured wooden handle and protective caps

Art. No.	size (mm)	rail (mm)
11100	100x50	15x5
11101	120x60	22x6
11102	160x80	25x6
11103	200x100	30x8
11104	250x120	30x8
11105	300x140	35x9
11106	400x175	35x9
11199	400x120	35x11
11200	500x120	35x11
11201	600x120	35x11
11202	800x120	35x11
11203	1000x120	35x11
11204	1250x120	35x11
11205	1500x120	35x11
11206	2000x120	35x11
11207	2500x120	35x11
11208	3000x120	35x11



**KISTENMACHER brand cast iron F-Clamps,**  
galvanized grooved hollow section bar,  
black clamp, with blue-black coloured  
Power-Grip handle and protective caps

Art. No.	size (mm)	rail (mm)
22100	100x50	15x5
22101	120x60	22x6
22102	160x80	25x6
22103	200x100	30x8
22104	250x120	30x8
22105	300x140	35x9
22106	400x175	35x9
22199	400x120	35x11
22200	500x120	35x11
22201	600x120	35x11
22202	800x120	35x11
22203	1000x120	35x11
22204	1250x120	35x11
22205	1500x120	35x11
22206	2000x120	35x11
22207	2500x120	35x11
22208	3000x120	35x11



**KISTENMACHER brand cast iron F-Clamps,**  
galvanized grooved hollow section bar,  
silver galvanized clamp, with blue-black coloured  
Power-Grip and protective caps

Art. No.	size (mm)	rail (mm)
52100	100x50	15x5
52101	120x60	22x6
52102	160x80	25x6
12103	200x100	30x8
12104	250x120	30x8
12105	300x140	35x9
12106	400x175	35x9
12199	400x120	35x11
52200	500x120	35x11
52201	600x120	35x11
52202	800x120	35x11
12203	1000x120	35x11
12204	1250x120	35x11
12205	1500x120	35x11
12206	2000x120	35x11
12207	2500x120	35x11
12208	3000x120	35x11



## Hand Saws



**Baghdad Hand Saws**  
with wooden rivetted handle,  
lacquered



Art. No.	length (mm/inch)	tpi
119/400	400 / 16"	7
119/450	450 / 18"	7

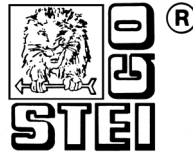

## Hand Saws

with closed wooden rivetted handle,  
lacquered



Art. No.	length	tpi
612/300	300 / 12"	8
612/350	350 / 14"	8
612/400	400 / 16"	7
612/450	450 / 18"	7
612/500	500 / 20"	7
612/550	550 / 22"	7

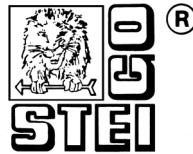

## Pruning Saws

with wooden handle, thickness of blade 0.7 mm



Art. No.	length	tpi
631/300	300 / 12"	5
631/350	350 / 14"	5
631/400	400 / 16"	5

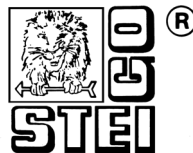

## TCT Hand Saws

with carbide tipped teeth and  
closed wooden handle



Art. No.	length	tpi
903/17	700 / 28"	17
903/34	700 / 28"	34





## Hand Saws & Fretsaws



### Junior Hack Saws

with red beechwood handle, zinc-plated frame made of 6 mm round steel, fitted with a PUK universal saw blade

Art. No.	length
305100	290 mm



### Metal Bar Saws

black powder coated with beechwood handle, fitted with a PUK bi-metal sawblade 300 mm / 24 tpi

Art. No.	length
B31102	510 mm



### Fret Saw Frames

extremely solid, made of 13 mm round steel, black coated with red beechwood handle

Art. No.	length (mm/inch)
490001	345 / 13.8



### Fret Saw Blades for wood

- TAIFUN version: packing with yellow cover at both ends
- TORNADO version: packed in plastic foil
- CRAFTA version: packing with light blue cover at both ends

No.	Art. No. TAIFUN double teeth	Art. No. TAIFUN skip teeth	Art. No. TORNADO spiral teeth	Art. No. CRAFTA double teeth	Art. No. CRAFTA skip teeth	Art. No. CRAFTA regular teeth
mixed	501920	511920		601920	611920	621920
2/0	502020	512020	E524016	602020	612020	622020
0	500020	510020	E524010	600020	610020	620020
1	500120	510120	E524011	600120	610120	620120
2	500220	510220	E524012	600220	610220	620220
3	500320	510320	E524013	600320	610320	620320
4	500420	510420	E524014	600420	610420	620420
5	500520	510520	E524015	600520	610520	620520
7	500720	510720		600720	610720	620720
9	500920	510920		600920	610920	620920
11	501120	511120		601120	611120	621120
12		511220			611220	





## Hand Hack Saw Blades

### KISTENMACHER brand Universal Hand Hack Saw Blades

made of alloyed steel - flexible  
single side tothing with wavy setting  
suited for steel cutting

10 pcs/bundle - 100 pcs/blue box - 10 boxes/carton



Art. No.	size (mm)	tpi
SF-D08-100	300 x 13 x 0,65	18
SF-D10-100	300 x 13 x 0,65	24
SF-D12-100	300 x 13 x 0,65	32



### KISTENMACHER brand HSS-BI Metal Hand Hack Saw Blades

made of super-alloyed high speed steel - super flexible  
single sided tothing with wavy setting  
suited for steel cutting

10 pcs/bundle - 100 pcs/orange box - 10 boxes/carton



Art. No.	size (mm)	tpi
HSSM2-D08-100	300 x 13 x 0,65	18
HSSM2-D10-100	300 x 13 x 0,65	24
HSSM2-D12-100	300 x 13 x 0,65	32



### GLOBUS brand Hand Hack Saw Blades

carbon steel, single side or double side tothing

RAMb: 72 pcs/cartonbox - 20 cartonboxes in wooden case  
RAMc: 144 pcs/cartonbox - 20 cartonboxes in wooden case



Art. No.	size (mm)	tpi	tothing
RAMb	300 x 25.0 x 0.6	24	double side
RAMc	300 x 12.5 x 0.6	24	single side



### G-MAN brand Hand Hack Saw Blades

single sided tothing suited for carbon steel

10 pcs/bundle - 100 pcs/grey box - 10 boxes/carton



Art. No.	size (mm)	tpi
3040-3024GM	300 x 12,5 x 0,60	24



Other sizes and tpi available upon request

## Hand Saws and Bow Saw Blades

**G-MAN brand HSS flexible  
Hack Saw Blades**  
single sided tooththing

10 pcs/bundle - 100 pcs/grey box - 10 boxes/carton



Art. No.	size (mm)	tpi
3042-3042GM	300 x 12,5 x 0,65	24



**G-MAN brand BI-metal  
Hack Saw Blades**  
single sided tooththing

10 pcs/bundle - 100 pcs/grey box - 10 boxes/carton



Art. No.	size (mm)	tpi
3003-3018GM	300 x 12,5 x 0,60	18
3003-3024GM	300 x 12,5 x 0,60	24
3003-3032GM	300 x 12,5 x 0,60	32



**G-MAN brand Universal Hand Saws Classic U7**  
with a comfortable plastic handle with 3 screws,  
supplied in hard point finish



Art. No.	size (inch/mm)
328H16U7	16/400
328H18U7	18/450
328H20U7	20/500
328H22U7	22/550
328H24U7	24/600



**cutBRIK brand Bow Saws**

with yellow steel frame and black quick release,  
including saw blades No. 18

Art. No.	size (inch/mm)
15 B18-300	12/300



Art. No.	size (inch/mm)
50 B18-610	24/610
50 B18-762	30/762
50 B18-914	36/914



**cutBRIK brand Hack Saws**

with yellow steel frame and black handle  
bi-metal blade



Art. No.	size (inch/mm)
16 B18-300	12/300



**cutBRIK brand Saw Blades for Bow Saws**

200 pcs per box

- Ref. 10 for dry wood
- Ref. 18 for green wood

Art. No.	size (inch/mm)
10 / 18	12/300
10 / 18	18/460
10 / 18	21/533
10 / 18	24/610
10 / 18	30/762



# Circular Saw Blades



## EDN brand Carbide Tipped Circular Sawblades

- for cutting wood
- for cutting aluminium - negative teeth

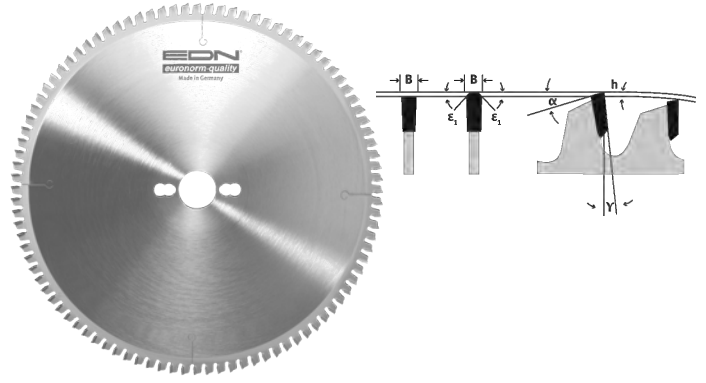
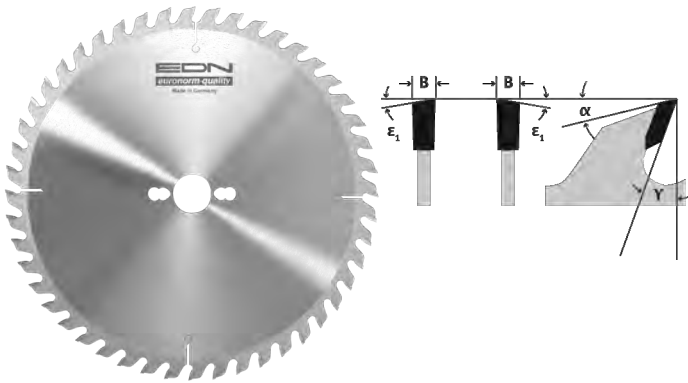

WOOD Art. No. 76950...	ALUMINIUM Art. No. 76956...	teeth	size x width (mm)	WOOD Art. No. 76950...	ALUMINIUM Art. No. 76956...	teeth	size x width (mm)	WOOD Art. No. 76950...	ALUMINIUM Art. No. 76956...	teeth	size x width (mm)
150024		24	150 x 3.0	250024		24	250 x 3.2	350120	350120	120	350 x 3.6
150030		30	150 x 3.0	250030		30	250 x 3.2	400048		48	400 x 3.6
150036		36	150 x 3.0	250040		40	250 x 3.2	400060		60	400 x 3.6
150048	150048	48	150 x 3.0	250048		48	250 x 3.2	400072	400072	72	400 x 3.6
160036		36	160 x 2.5	250060	250060	60	250 x 3.2	400084		84	400 x 3.6
160048		48	160 x 2.5	250080	250080	80	250 x 3.2	400096	400096	96	400 x 3.6
180024		24	180 x 3.0		250096	96	250 x 3.2	400108	400108	108	400 x 3.6
180030		30	180 x 3.0	300028		28	300 x 3.2	400120	400120	120	400 x 3.6
180036		36	180 x 3.0	300036		36	300 x 3.2	400132		132	400 x 3.6
180042		42	180 x 3.0	300048	300048	48	300 x 3.2	450066		66	450 x 4.0
180048		48	180 x 3.0	300060	300060	60	300 x 3.2	450072		72	450 x 4.0
180056		56	180 x 3.0	300072	300072	72	300 x 3.2	450084		84	450 x 4.0
200034		34	200 x 3.0	300084	300084	84	300 x 3.2	450096	450096	96	450 x 4.0
200042		42	200 x 3.0	300096	300096	96	300 x 3.2	450108	450108	108	450 x 4.0
200048		48	200 x 3.0	350036		36	350 x 3.6	450120	450120	12	450 x 4.0
200064	200064	64	200 x 3.0	350042		42	350 x 3.6	450132	450132	132	450 x 4.0
230034		34	230 x 3.0	350048		48	350 x 3.6	500072		72	500 x 4.0
230042		42	230 x 3.0	350054		54	350 x 3.6	500096	500096	96	500 x 4.0
230048		48	230 x 3.0	350060		60	350 x 3.6	500120	500120	120	500 x 4.0
230060		60	230 x 3.0	350072	350072	72	350 x 3.6				
230064		64	230 x 3.0	350084	350084	84	350 x 3.6				
230072	230072	72	230 x 3.0	350096	350096	96	350 x 3.6				
230080	230080	80	230 x 3.0	350108	350108	108	350 x 3.6				

Other sizes are available upon request

**EDN**<sup>®</sup>  
*euronorm quality*

# Circular Saw Blades



## EDN brand Carbide Tipped Circular Sawblades

Typ 061 VTF

for cutting single- and double-sided plastic coated panel materials

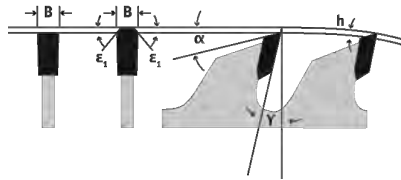

Art. No.	teeth	size x width (mm)
061 VTF 180048	48	180 x 3.2
061 VTF 200064	64	200 x 3.2
061 VTF 230072	72	230 x 3.2
061 VTF 250080	80	250 x 3.2
061 VTF 300096	96	300 x 3.2
061 VTF 350108	108	350 x 3.5

**EDN**<sup>®</sup>  
euronorm quality

## DRESS brand Metal Cutting Circular Sawblades

made of HSS /DMo5 for sawing machines, vaporized

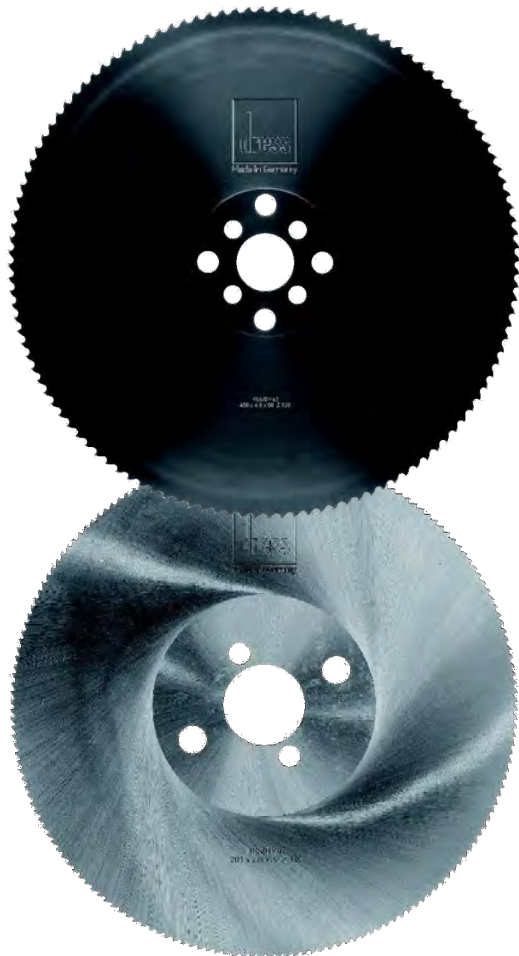

Art. No.	teeth	size x width (mm)
725025G	250	250 x 2,5
730030G	300	300 x 2,5

Other sizes and several bore diameters are available upon request.



## Band Saws



### Band saws for cutting wood

made of special steel CR-300,  
hardened, polished,  
toothed NV (A), set-machine sharp

available on rolls of 22, 25 and 50 m

Art. No.	size
120606/R	12 x 0,6 x 6 mm
150606/R	15 x 0,6 x 6 mm
200606/R	20 x 0,6 x 6 mm
200607/R	20 x 0,6 x 7 mm
200608/R	20 x 0,6 x 8 mm
200708/R	20 x 0,7 x 8 mm
250608/R	25 x 0,6 x 8 mm
250708/R	25 x 0,7 x 8 mm
300709/R	30 x 0,7 x 9 mm
300809/R	30 x 0,8 x 9 mm
350810/R	35 x 0,8 x 10 mm
400810/R	40 x 0,8 x 10 mm
400910/R	40 x 0,9 x 10 mm
450811/R	45 x 0,8 x 11 mm
500912/R	50 x 0,9 x 12 mm
601014/R	60 x 1,0 x 14 mm



**Remark:**

available in set and sharpened or unset versions

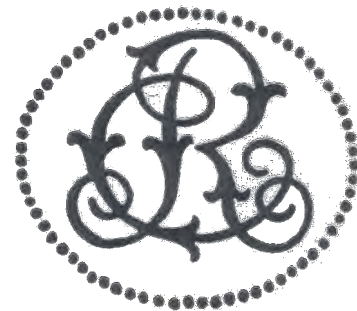
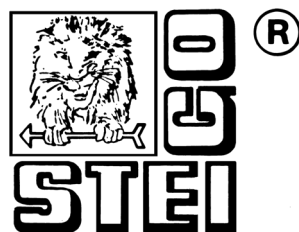

## Lifting Equipment

### Mechanical Rack Jacks

with safety crank,  
blue lacquered



Art. No.	capacity (ton)
15-00/2.5	2.5
15-00/5	5.0
15-01/10	10
15-01/16	16
Z23	20

### Rope Hoist Type 30

blue lacquered, incl.  
steel rope with hook  
(packed separately)



Art. No.	capacity (ton)	rope length (m)
30-10/20	0.8	20
30-10/40	0.8	40
30-10	-	w/o rope
30-00/20	1.6	20
30-00/40	1.6	40
30-00	-	w/o rope
30-11/20	3.2	20
30-11/40	3.2	40
30-11	-	w/o rope



### Lever Jacks

with link chain  
Type „RZC“,  
1.5 m lifting



Art. No.	capacity (ton)
RZC0.8	0.8
RZC1.6	1.6
RZC3.2	3.2
RZC5.0	5.0



### Pioneer Pipe Vice Stand

Universal stand-mounted steel pipe vice with hardened steel jaws, stable floor, easily transportable and ready set up and varnished body, red colour

range: 1/4" - 3"

Art. No. **Pioneer 03**



### THIELE Brand Steel Chains Grade 80

class 8, made of alloy steel, acc. to German standard DIN 5687-8, elongation at break-point 17%, black coloured, goods are packed in drums, with test certificate

Art. No.	working load (ton)	trade size (mm)
F01465	2.0	8-8
F01470	3.15	10-8
F01475	5.3	13-8
F01480	8.0	16-8
F01485	10.0	18-8
F01490	12.5	20-8
F01500	15.0	22-8
F01515	21.2	26-8
F01525	31.5	32-8

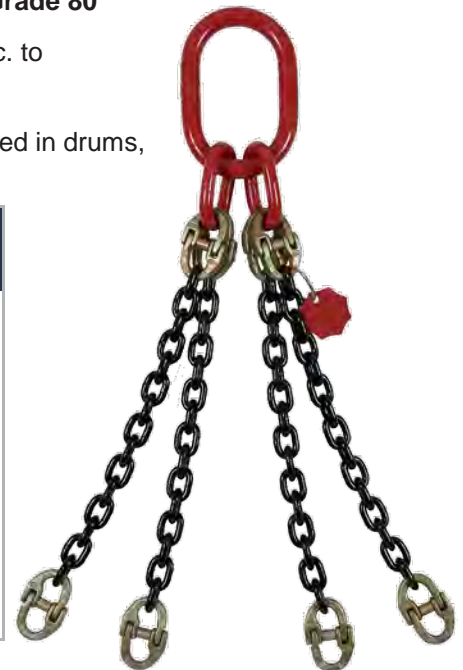

# Lifting Equipment



## Oblong Master Links TWN 0831

for single leg slings, red



Art. No.	working load (ton)	D (mm)	trade size(mm)
F12008	1.12	13	6-8
F12012	2.00	16	8-8
F12018	3.15	18	10-8
F12034	5.3	22	13-8
F12052	8.0	26	16-8
F12094	10.0	32	18-8
F12116	12.5	36	20-8
F12120	15.0	36	22-8
F12168	21.2	45	26-8
F12172	25.0	45	28-8
F12198	31.5	50	32-8
F12226	40.0	56	36-8
F12244	50.0	63	40-8

## Oblong Master Links TWN 0832

for double leg slings, red



Art. No.	working load (ton)	D (mm)	trade size(mm)
F12014	1.6	13	6-8
F12020	2.8	18	8-8
F12036	4.25	22	10-8
F12054	7.5	26	13-8
F12096	11.2	32	16-8
F12118	14.0	36	18-8
F12152	17.0	40	20-8
F12170	21.2	45	22-8
F12200	30.0	50	26-8
F12202	33.5	50	28-8
F12228	45.0	56	32-8
F12246	56.0	63	36-8
F12250	71.0	71	40-8

## Master Link Assemblies TWN 0831

for 3- and 4-leg slings, red



Art. No.	working load (ton)	D (mm)	trade size(mm)
F12342	2.36	18	6-8
F12354	4.25	22	8-8
F12362	6.7	26	10-8
F12398	11.2	32	13-8
F12422	17.0	36	16-8
F12452	21.2	45	18-8
F12468	26.5	50	20-8
F12472	31.5	50	22-8
F12482	45.0	56	26-8
F12488	50.0	63	28-8
F12492	67.0	71	32-8
F12498	85.0	80	36-8
F12502	106.0	90	40-8

## Chain Connectors Type „KWS“ grade 80

retainer electro galvanized, red



Art. No.	working load (ton)	trade size (mm)
Z07400	1.12	5/6-8
Z07401	2.0	7/8-8
Z07402	3.15	10-8
Z07403	5.3	13-8
Z07404	8.0	16-8

## THI-LOK Connectors TWN 0829



Art. No.	working load (ton)	trade size (mm)
F30800	1.12	6-8
F30005	1.5	7-8
F30810	2.0	8-8
F30820	3.15	10-8
F30830	5.3	13-8
F30840	8.0	16-8
F30850	10.0	18-8
F30855	122.5	20-8
F30860	15.0	22-8
F30870	21.2	26-8
F30880	31.5	32-8





# Lifting Equipment

## Self-Locking Clivis Hooks

TWN 0799, red



Art. No.	working load (ton)	trade size (mm)
Z07279	1.12	6-8
Z07280	2.00	8-8
Z07281	3.15	10-8
Z07282	5.3	13-8
Z07283	8.0	16-8
Z07503	12.5	18/20-8

## Sling Hooks

TWN 0835/1

with pin coupling



Art. No.	working load (ton)	trade size (mm)
F33601	1.12	6-8
F33611	2.0	8-8
F33621	3.15	10-8
F33631	5.3	13-8
F33641	8.0	16-8
F33651	10.0	18-8
F33656	12.5	20-8
F33661	15.0	22-8

## Swivel Hooks

TWN 0854

with safety latch, red



Art. No.	working load (ton)	trade size (mm)
F32100	1.12	6-8
F32110	2.00	8-8
F32120	3.15	10-8
F32130	5.3	13-8
F32140	8.0	16-8

## „SOLIDO“ - Eye Slip Hooks

TWN 0858/1

with safety latch, red



Art. No.	working load (ton)	trade size (mm)
F32901	1.12	6-8
F32911	2.0	8-8
F32921	3.15	10-8
F32931	5.3	13-8
F32941	8.0	16-8
F32951	12.5	18/20-8
F32971	15.0	22-8
F32981	21.2	26-8
F32991	31.5	32-8

## Shortening / Grab Hooks

TWN 0827/1

cradle type with pin



Art. No.	working load (ton)	trade size (mm)
F33201	2.0	8-8
F33211	3.15	10-8
F33221	5.3	13-8
F33231	8.0	16-8
F33246	12.5	20-8

## Self-Locking Eye Hooks

TWN 0798, red



Art. No.	working load (ton)	trade size (mm)
Z07274	1.12	6-8
Z07275	2.0	7/8-8
Z07276	3.15	10-8
Z07277	5.3	13-8
Z07278	8.0	16-8
Z03344	12.5	18/20-8
Z03329	15.0	22-8





## Spirit Levels



Strong aluminium box section, 22/50 mm, sharp-edged, extruded, heat cured, with torsional stiffness, usable as a drawing aid on all sides



SHARP EDGES

### NIVEAU NORM Type 95

strato-silver anodized  
1 horizontal vial,  
1 vertical vial

### NIVEAU NORM Type 85

powder-coated in signal colour  
1 horizontal vial,  
1 vertical vial

### NIVEAU NORM Type 95M

strato-silver anodized  
1 horizontal vial,  
1 vertical vial  
with strong magnets

### NIVEAU NORM Type 85M

powder-coated in signal colour  
1 horizontal vial,  
1 vertical vial  
with strong magnets

Art. No.	length (cm)
95030	30
95040	40
95050	50
95060	60
95070	70
95080	80
95090	90
95100	100
95120	120
95150	150
95180	180
95200	200

Art. No.	length (cm)
85030	30
85040	40
85050	50
85060	60
85070	70
85080	80
85090	90
85100	100
85120	120
85150	150
85180	180
85200	200

Art. No.	length (cm)
95030M	30
95040M	40
95050M	50
95060M	60
95070M	70
95080M	80
95090M	90
95100M	100
95120M	120
95150M	150
95180M	180
95200M	200

Art. No.	length (cm)
85030M	30
85040M	40
85050M	50
85060M	60
85070M	70
85080M	80
85090M	90
85100M	100
85120M	120
85150M	150
85180M	180
85200M	200

### available at a surcharge:

3rd vial 90°  
3rd vial 45°

alternatively  
horizontal vial with 2 additional rings  
for setting out 2% slopes





## Spirit Levels



Strong aluminium box section, 22/50 mm, extruded, heat cured, with torsional stiffness and pleasantly rounded edges

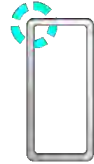

SOFT EDGES

### NIVEAU SOFT Type 92

strato-silver anodized  
1 horizontal vial,  
1 vertical vial

### NIVEAU SOFT Type 82

powder-coated in signal colour  
1 horizontal vial,  
1 vertical vial

### NIVEAU SOFT Type 92M

strato-silver anodized  
1 horizontal vial,  
1 vertical vial  
with strong magnets

### NIVEAU SOFT Type 82M

powder-coated in signal colour  
1 horizontal vial,  
1 vertical vial  
with strong magnets

Art. No.	length (cm)
92030	30
92040	40
92050	50
92060	60
92070	70
92080	80
92090	90
92100	100
92120	120

Art. No.	length (cm)
82030	30
82040	40
82050	50
82060	60
82070	70
82080	80
82090	90
82100	100
82120	120

Art. No.	length (cm)
92030M	30
92040M	40
92050M	50
92060M	60
92070M	70
92080M	80
92090M	90
92100M	100
92120M	120

Art. No.	length (cm)
82030M	30
82040M	40
82050M	50
82060M	60
82070M	70
82080M	80
82090M	90
82100M	100
82120M	120

#### available at a surcharge:

3rd vial 90°  
3rd vial 45°

alternatively  
horizontal vial with 2 additional rings  
for setting out 2% slopes

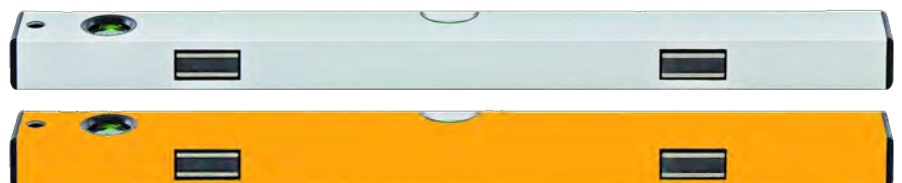



## Spirit Levels & Measuring Tapes

Extra strong aluminium box section, 23/50 mm, sharp-edged, extruded, heat cured, with high torsional stiffness, and usable as a drawing aid on all sides

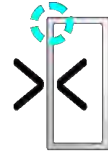

EXTRA STRONG

### NIVEAU BIG Type 97

golden anodized  
1 horizontal vial,  
1 vertical vial

horizontal vial with fluorescent  
backing plate allows measuring  
in subdued lights

Art. No.	length (cm)
97030	30
97040	40
97050	50
97060	60
97070	70
97080	80
97090	90
97100	100
97120	120
97150	150
97180	180
97200	200



**KISTENMACHER** brand pocket-sized measuring tapes are the ideal solution for everyday tasks in manufacturing, construction and at home.

The heavy-duty ABS case is ergonomically shaped for easy handling and equipped with a carrying strap as well as a belt clip.



Art.-No.	length	width	pcs. / box
EGK TMB1-2/13	2,0 m / 6 ft.	13 mm	120 pcs.
EGK TMB1-3/13	3,0 m / 10 ft.	13 mm	120 pcs.
EGK TMB1-3/19	3,0 m / 10 ft.	19 mm	120 pcs.
EGK TMB1-3.6/13	3,6 m / 12 ft.	13 mm	72 pcs.
EGK TMB1-3.6/19	3,6 m / 12 ft.	19 mm	72 pcs.
EGK TMB1-5/19	5,0 m / 16 ft.	19 mm	72 pcs.
EGK TMB1-5/25	5,0 m / 16 ft.	25 mm	72 pcs.
EGK TMB1-5/28	5,0 m / 16 ft.	28 mm	72 pcs.
EGK TMB1-5.5/19	5,5 m / 18 ft.	19 mm	72 pcs.
EGK TMB1-5.5/25	5,5 m / 18 ft.	25 mm	72 pcs.
EGK TMB1-5.5/28	5,5 m / 18 ft.	28 mm	72 pcs.
EGK TMB1-6.5/25	6,5 m / 21 ft.	25 mm	48 pcs.
EGK TMB1-7.5/25	7,5 m / 25 ft.	25 mm	48 pcs.
EGK TMB1-8/25	8,0 m / 27 ft.	25 mm	48 pcs.
EGK TMB1-9/25	9,0 m / 30 ft.	25 mm	48 pcs.
EGK TMB1-9/28	9,0 m / 30 ft.	28 mm	48 pcs.
EGK TMB1-10/25	10,0 m / 33 ft.	25 mm	48 pcs.

## Measuring Tapes

All Measuring Tapes: width: 13 mm: with 2 measures start „C“ (Standard)

**optional measurement commencements:**

**Massanfang A**



**Massanfang B**

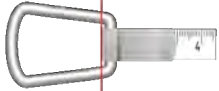

**Massanfang C**

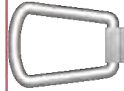

A: Measurement commencement approx. 10 cm after end fitting

B: Measurement commencement at front fitting edge

C: Measurement commencement at front ring edge

### WEISS brand Measuring Tapes

in steel case with artificial leather coating, metal axle at the crank lever's core ensures long term use



#### Fibreglass white

Art. No. cm/inch	Art. No. mm/inch	length (m)
287 GL/5	287 GLM/5	5
287 GL/10	287 GLM/10	10
287 GL/15	287 GLM/15	15
287 GL/20	287 GLM/20	20
287 GL/25	287 GLM/25	25
287 GL/30	287 GLM/30	30

#### Steel white enamelled

Art. No. cm/inch	Art. No. mm/inch	length (m)
208 WE/5	208 WEM/5	5
208 WE/10	208 WEM/10	10
208 WE/15	208 WEM/15	15
208 WE/20	208 WEM/20	20
208 WE/25	208 WEM/25	25
208 WE/30	208 WEM/30	30

#### Steel yellow enamelled

Art. No. cm/inch	Art. No. mm/inch	length (m)
287 GE/5	287 GEM/5	5
287 GE/10	287 GEM/10	10
287 GE/15	287 GEM/15	15
287 GE/20	287 GEM/20	20
287 GE/25	287 GEM/25	25
287 GE/30	287 GEM/30	30

### Plumb Bobs

#### BOB No. 1

brass, cylindrical, flattened on two sides, 70 mm long, Ø 25 mm, graduations: mm/-, mm/mm, mm/inch, weight 240 g

#### BOB No. 2

brass, cylindrical, 120 mm long, Ø 20 mm, without graduation, weight 260 g

#### BOB No. 3

brass, cylindrical, flattened on two sides, 170 mm long, Ø 25 mm, graduation: mm/-, mm/mm, mm/inch, weight 470 g

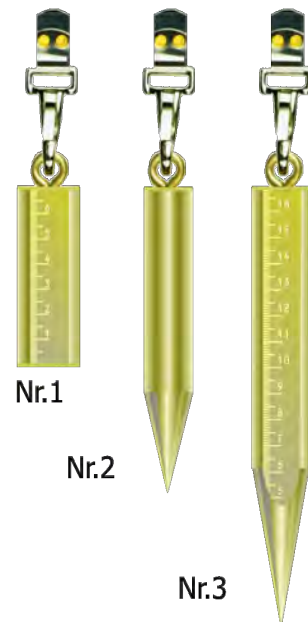

## Measuring Tapes

### WEISS brand Measuring Tapes - TYPE 600 angular

white enamelled steeltape, with black plastic handle and steel nickel plated crank, on anodized aluminium frame, graduation cm/inch

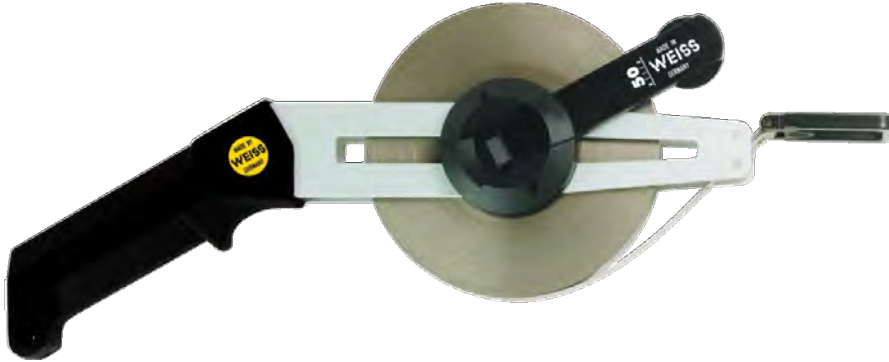

Art. No. cm/inch	length (m)
621 WE/15	15
621 WE/20	20
621 WE/25	25
621 WE/30	30
621 WE/40	40
621 WE/50	50

### WEISS brand Measuring Tapes - TYPE 700 - straight

white enamelled steel tape, with black plastic handle and steel nickel plated crank, on anodized aluminium frame, graduation cm/inch

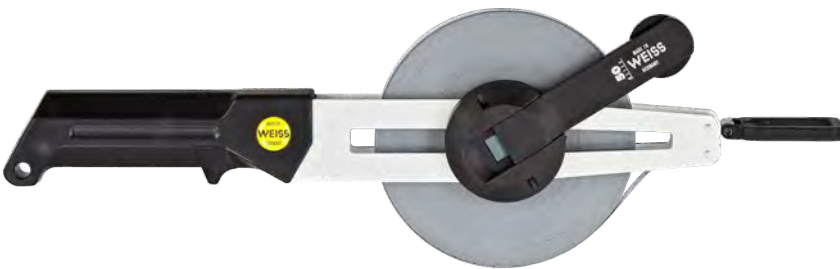

Art. No. cm/inch	length (m)
721 WE/15	15
721 WE/20	20
721 WE/25	25
721 WE/30	30
721 WE/40	40
721 WE/50	50

### WEISS brand Measuring Tapes - TYPE 800 straight

white enamelled steel tape, with black plastic handle and steel nickel plated crank, on anodized aluminium triangle frame, graduation cm/inch



Art. No. cm/inch	length (m)
821 WE/20	20
821 WE/25	25
821 WE/30	30
821 WE/40	40
821 WE/50	50
821 WE/100	100

### WEISS brand Measuring Tapes - TYPE 900 angular

white enamelled steel tape, with black plastic handle and steel nickel plated crank, on anodized aluminium triangle frame, graduation cm/inch

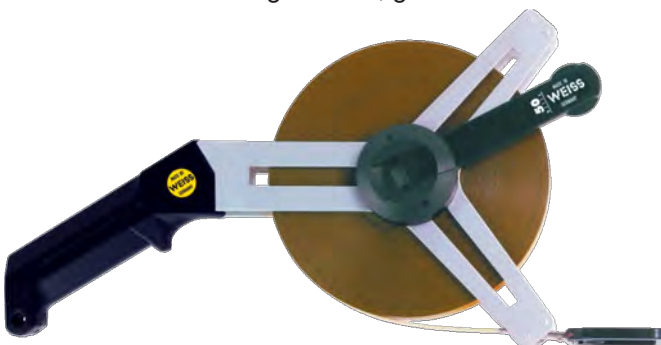

Art. No. cm/inch	length (m)
921 WE/20	20
921 WE/25	25
921 WE/30	30
921 WE/40	40
921 WE/50	50
921 WE/100	100

## Measuring Tapes



All Measuring Tapes: width: 13 mm: with 2 measures start „L“ (bob connection)

### Weight 11

brass, cylindrical, no graduation, length 190 mm, Ø 24 mm, weight 500 g (can be removed from the tape)

Art. No. 340 00 11



### Weight 10

brass, cylindrical, engraved mm scale on one side and inch scale on other side, length 89 mm, dia. 24 mm, weight 300 g (can be removed from the tape)

Art. No. 340 02 10

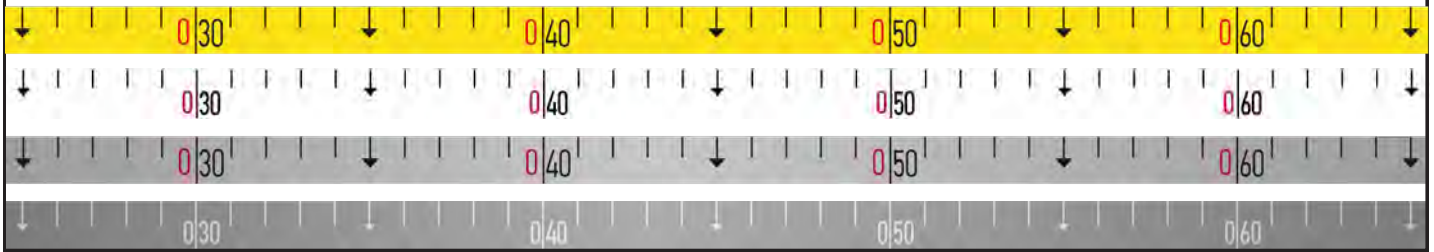
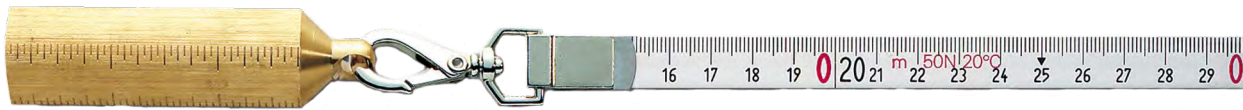

### BMI brand Measuring Tapes - straight

13 mm, with black plastic handle and steel nickel plated crank, on anodized aluminium triangle frame

available in

- Fibreglass yellow
- Steel white enamelled
- High etched Carbon Steel black
- High etched Stainless Steel enamelled



#### Fibreglass yellow

Art. No. cm/inch	Art. No. mm/inch	length (m)
505213010A	505215010A	10
505213015A	505215015A	15
505213020A	505215020A	20
505213025A	505215025A	25
505213030A	505215030A	30
505213050A	505215050A	50

#### Steel white enamelled

Art. No. cm/inch	Art. No. mm/inch	length (m)
501213010A	501215010A	10
501213015A	501215015A	15
501213020A	501215020A	20
501223025A	501225025A	25
501223030A	501225030A	30
501233050A	501235050A	50

#### High etched Carbon Steel black

Art. No. cm/inch	Art. No. mm/inch	length (m)
511313010A	511315010L	10
511313015A	511315015A	15
511313020A	511315020A	20
511313025A	511315025A	25
511313030A	511315030A	30
511313050A	511325050A	50

#### High etched Stainless Steel enamelled

Art. No. cm/inch	Art. No. mm/inch	length (m)
509213010A	509215010A	10
509213015A	509215015A	15
509213020A	509215020A	20
509223025A	509225025A	25
509223030A	509225030A	30
509233050A	509235050A	50



## Measuring Tapes



### BMI brand Steel Measuring Tapes

white enamelled, on anodized aluminium frame,  
with black plastic handle



Art. No. cm/inch	Art. No. mm/inch	length (m)
501013010C	501015010C	10
501013015C	501015015C	15
501013020C	501015020C	20
501013025C	501015025C	25
501013030C	501015030C	30
501013050C	501015050C	50

### BMI brand Steel Measuring Tapes

white enamelled, on anodized aluminium triangle frame,  
with black plastic handle



Art. No. cm/inch	Art. No. mm/inch	length (m)
501033050C	501035050C	50
501043100C	501045100C	100

### BMI brand Measuring Tapes

RADIUS case series

Ergonomically shaped case with large crank arm  
and park position for commencement ring. Slide bearing shells  
for highest winding comfort. with easy grip soft-touch surface.

#### Fibreglass yellow

Art. No. mm/inch	length (m)
520215010A or C	10
520215015A or C	15
520215020A or C	20
520215025A or C	25
520215030A or C	30
520215050A or C	50

#### Steel white enamelled

Art. No. mm/inch	length (m)
501215010A or C	10
501215015A or C	15
501215020A or C	20
501225025A or C	25
501225030A or C	30
501235050A or C	50





## Special Spirit Levels & Plastic Spirit Levels

### ULTRASONIC

- length 25 cm
- vertical headvial
- turnable anglevial
- 2 % slope marking in the horizontal vial
- magnetic
- accuracy 0,5 mm/m

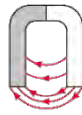

Art. No. **692 025 TWM**

- length 20 cm
- vertical headvial
- horizontal vial with magnifying effect
- magnetic
- accuracy 0,5 mm/m also for inverted measurement



Art. No. **692 020 M**

### Torpedo-Spirit Level

- length 25 cm
- Alu die-cast model
- milled surface
- magnetic
- accuracy 0,5 mm/m



Art. No. **689 025 TM**

### Line-Level

line level made of ABS with clip.  
eyelet to hook on to a levelling line,  
plexiglass vials.



Art. No. **675 012 003**

### TORPEDO

sturdy spirit levels made of reinforced fibre glass  
ABS-plastic. round vials allows good readability.  
magne execution (685M) equipped with two  
strong disc magnets.

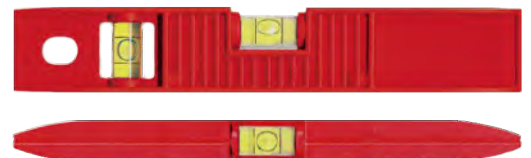

Art. No.	version	dimensions	PU
685 025 002	without magnet	250 x 43 x 002 mm	10
685 025 002 M	with magnet	250 x 43 x 002 mm	10
685 025 003	without magnet +blister packing	250 x 43 x 002 mm	10
685 025 003 M	with magnet + blister pcking	250 x 43 x 002 mm	10



## Levelling Instrument (automatic/optic)

### Builder's level

automatic self-levelling. Very short minimum target distance. Additional rough sight.



#### Box

dimensions  
270 x 170 x 180 mm

Art. No.	version	magnification	lens opening
646 2024	instrument with box	x 24	36 mm
646 2024 SET	instrument with box, tripod, tenimeter	x 24	36 mm
646 2032	instrument with box	x 32	42 mm
646 2032 SET	instrument with box, tripod, tenimeter	x 32	42 mm

technical data telescope		technical data horizontal circle	
length:	200 mm	diameter	110 mm
shortest target distance	0,9 m	graduation	0 - 400 gon
cm-estimate	150 m	numbering	1 gon
mid km-error	± 2,5 mm		
compensator	magnet		
dimensions	220 x 135 x 135 mm		
weight	1,9 kg		

## Measuring Devices

### Road Measuring Wheels

handle foldable, capacity: 9.999,99 m, 1cm reading,  
wheel diameter 318,5 mm = 1 m circumference,  
substracts and adds

tolerance below 0,05%, built in stand, integrated brake  
colour: orange enamelled

**Art. No. 1200 2001** weight: 3.900 gr - solid full wheel  
**Art. No. 1200 6001** weight: 3.300 gr - spoke wheel



### Road Measuring Wheels

handle foldable, capacity: 9.999,99 m, 1cm reading,  
wheel diameter 160 mm = 50 cm circumference,  
substracts and adds, foldable handle for space-saving  
transport

tolerance below 0,1%, integrated brake  
orange powder coated frame

**Art. No. 1201 4000** weight: 1.300 gr - full disc wheel



### Transport Case

artificial leather, for road measuring wheel  
1200 2001 + 1200 6001

2 safety locks, strong handle  
colour: black  
weight: 2200 g

**Art. No. 1290 0000**



### Transport/Carrying bag

for measuring wheel 1201 4000

**Art. No. 1290 3000**



## Pocket Spring Balances + Vernier Caliper



### Pocket Spring Balances „ORIGINAL REBÜRE“

with iron-brassed scale and bright galvanized hook and ring, housing and pointer painted black

Art. No.	range (kg)
102100	0-10.0
102125	0-12.5
102200	0-20.0
102250	0-25.0
102300	0-30.0
102500	0-50.0
1021000	0-100.0



### Spring Balances „ORIGINAL REBÜRE“

standard execution, with iron-brassed, round scale and bright galvanized hook and ring, housing and pointer painted black

Art. No.	range (kg)
132010	0-10.0
132025	0-25.0
132050	0-50.0
132100	0-100.0
132150	0-150.0
132200	0-200.0
132300	0-300.0



### Vernier Caliper

made of tool steel, scale and nonius satin chrome finished, hardened, 4-way measurements, backside with screw table, in case

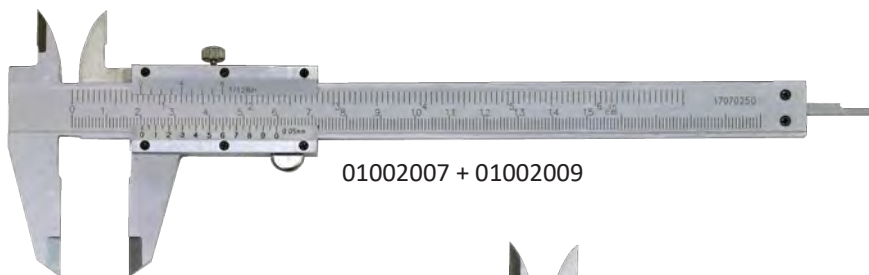

01002007 + 01002009

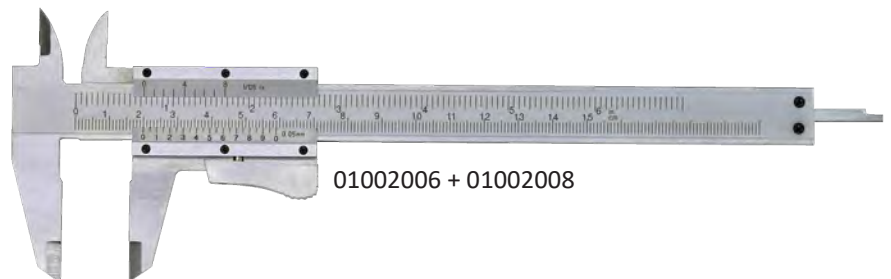

01002006 + 01002008

Art. No.	range (mm)	lockring	nonius mm below	nonius inch above	weight (kg)
01002007	150	screw	1/20 - 39	1/128"	0,15
01002009	200	screw	1/20 - 39	1/128"	0,18
01002006	150	auto	1/20 - 39	1/128"	0,15
01002008	200	auto	1/20 - 39	1/128"	0,18

## Precision Dividers & Scriber

### Spring Divider

with square legs, made of forged steel,  
with quick nut

Art. No.	length (mm)
1800-075	75
1800-100	100
1800-125	125
1800-150	150
1800-175	175
1800-200	200
1800-225	225
1800-250	250
1800-275	275
1800-300	300
1800-400	400
1800-500	500



### Inside Spring Divider

with square legs, made of forged steel,  
with quick nut

Art. No.	length (mm)
1801-075	75
1801-100	100
1801-125	125
1801-150	150
1801-175	175
1801-200	200
1801-225	225
1801-250	250
1801-275	275
1801-300	300
1801-400	400
1801-500	500



### Outside Spring Divider

with square legs, made of forged steel,  
with quick nut

Art. No.	length (mm)
1802-075	75
1802-100	100
1802-125	125
1802-150	150
1802-175	175
1802-200	200
1802-225	225
1802-250	250
1802-275	275
1802-300	300
1802-400	400
1802-500	500



### Bow Divider

with square legs, made of forged steel, with quick nut  
with adjustable screw hinge

Art. No.	length (mm)
478.101	150
1802-100	175
1802-125	200
1802-150	250
1802-175	300
1802-200	400
1802-225	500
1802-250	600



### Scriber

with straight and offset hardened steel tips,  
exchangeable, chrome-plated  
Length: 250 mm, Ø 8 mm  
length of straight tip: 100 mm  
length of offset tip: 75 mm

Art. No. **257-C**



## Feeler Gauges

### Precision feeler gauges tolerance according to T3 DIN 2275

length of blades 100 mm  
conical, width 12,7 mm

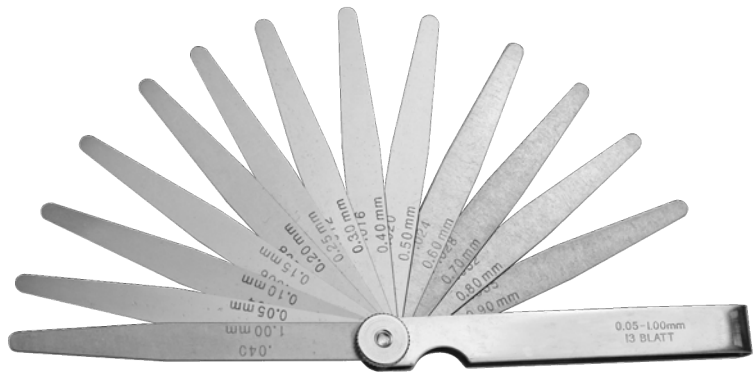

Art. No.	range (mm)	pcs/ set	set combination
08078002	0.05 - 0,50	8	0,05-0,10-0,15-0,20-0,25-0,30-0,40-0,50
08078006	0.05 - 1,00	13	0,05-0,10-0,15-0,20-0,25-0,30-0,40-0,50-0,60-0,70-0,80-0,90-1,00
08078009	0.05 - 1,00	20	0,05-0,10-0,15-0,20-0,25-0,30-0,35-0,40-0,45-0,50-0,55-0,60-0,65-0,70-0,75-0,80-0,85-0,90-0,95-1,00
08078014	0.03 - 1,00	26	0,03-0,04-0,05-0,06-0,07-0,08-0,09-0,10-0,15-0,20-0,25-0,30-0,35-0,40-0,45-0,50-0,55-0,60-0,65-0,70-0,75-0,80-0,85-0,90-0,95-1,00

### Precision feeler gauges on a ring, cylindrical

length of blades 150 - 1000 mm  
width 12,7 mm

Art. No. 13 blades	Art. No. 20 blades	length (mm)	range (mm)
08079020	08079030	150	0.05 - 1.00
08079021	08079031	200	0.05 - 1.00
08079022	08079032	300	0.05 - 1.00
08079023	08079033	400	0.05 - 1.00
08079024	08079034	500	0.05 - 1.00
08079025	08079035	600	0.05 - 1.00
08079026	08079036	800	0.05 - 1.00
08079027	08079037	1000	0.05 - 1.00

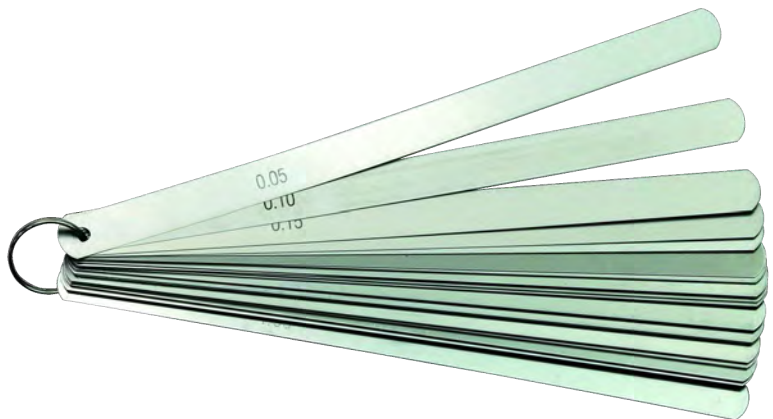

### Double thread calipers

for outside and inside measurements,  
whitworth thread: 4-62, metric thread 0.25 - 6.0

Art. No. **08081005** 52 blades  
Art. No. **08081006** 58 blades

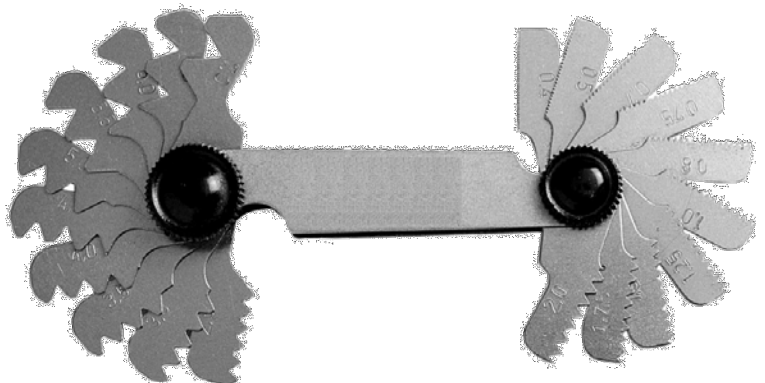

## Micrometer + Dial Indicator + Bevel

### Outside Micrometer

- with carbide measuring faces
- scale chrome finished
- frame metallic coated
- spindle diameter 6.5 mm
- thread pitch 0.5 mm
- with ratchet
- scale 0.01 mm, accuracy DIN 863
- at 25 - 0 mm with standard
- in case



Art. No.	range (mm)
01017070	0 - 25
01017071	25 - 50
01017072	50 - 75
01017073	75 - 100
01017074	100 - 125
01017075	125 - 150

### Dial Indicator

range 10 mm, reading 0.01 mm, accuracy according to works standard, metal casing, with tolerance marks, standard stem 8 h6, dial face rotatable by outer ring, in case

Art. No.	range (mm)	reading (mm)	accuracy $\mu\text{m}$	diameter C (mm)
01023005	10	0,01	17	56



### Joiner's adjustable sliding bevels with casting shank and thumb screw

with galvanized fixing screw



Art. No.	blade (mm)	handle (mm)	weight (kg)
03047000	200 x 20 x 0,8	22 x 10	0,120
03047001	250 x 20 x 0,8	22 x 10	0,150
03047002	300 x 20 x 0,8	22 x 10	0,160



## Protractor + Rulers

### Protractor, black aluminium, 0 - 180°

- double graduation 1°
- black aluminium (HRC63)
- scratch resistant
- hard coating
- reading 1° mm
- with fixing screw



Art. No.	of protractor (mm)	rule (mm)
05058030	80	120
05058031	120	150
05058032	150	200
05058033	200	300
05058034	300	500

### Stainless steel rulers „CHESTERMAN“

- reading from left to right
- spring stainless steel, graduation etched
- works standard

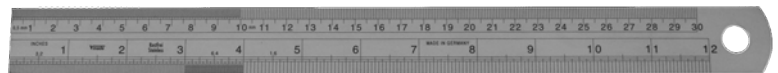

Art. No.	measurements (mm)	graduation	graduation / type
07074040	150 x 18 x 0,5	single-sided	inch/mm: top 1/64; 1/32 and 1/16 inch graduation, bottom 1/2 mm und 1/1 mm graduation
07074044	300 x 18 x 0,5	single-sided	inch/mm: top 1/64; 1/32 and 1/16 inch graduation, bottom 1/2 mm und 1/1 mm graduation
07074045	500 x 18 x 0,5	single-sided	inch/mm: top 1/64; 1/32 and 1/16 inch graduation, bottom 1/2 mm und 1/1 mm graduation
07074046	1000 x 18 x 0,5	single-sided	inch/mm: top 1/64; 1/32 and 1/16 inch graduation, bottom 1/2 mm und 1/1 mm graduation
07074047	2000 x 30 x 1,0	single-sided	inch/mm: top 1/2 and 1/1 mm graduation, bottom 1/64; 1/32 and 1/16 inch graduation

### Rulers, flexible steel, EG class II

- reading from left to right
- spring steel
- stainless, satin chrome finish
- flexible version



Art. No.	range (mm)	profile (mm)	graduation / type	graduation
07074000	100	13 x 0,5	B - 1, 2, 3, 1/2 mm/mm: top 1/2 mm, bottom 1/1 mm graduation	both-sided
07074001	150	13 x 0,5	B - 1, 2, 3, 1/2 mm/mm: top 1/2 mm, bottom 1/1 mm graduation	both-sided
07074002	200	13 x 0,5	B - 1, 2, 3, 1/2 mm/mm: top 1/2 mm, bottom 1/1 mm graduation	both-sided
07074003	250	13 x 0,5	B - 1, 2, 3, 1/2 mm/mm: top 1/2 mm, bottom 1/1 mm graduation	both-sided
07074004	300	13 x 0,5	B - 1, 2, 3, 1/2 mm/mm: top 1/2 mm, bottom 1/1 mm graduation	both-sided
07074005	500	18 x 0,5	B - 1, 2, 3, 1/2 mm/mm: top 1/2 mm, bottom 1/1 mm graduation	both-sided
07074006	1000	18 x 0,5	B - 1, 2, 3, 1/2 mm/mm: top 1/2 mm, bottom 1/1 mm graduation	single-sided
07074008	2000	18 x 0,5	B - 1, 2, 3, 1/2 mm/mm: top 1/2 mm, bottom 1/1 mm graduation	single-sided

Optionally available in profile 30 x 1,0 mm



## Industrial Accessories



### Piano Hinges

size 32 x 0.6 mm, in lengths of 3500 mm,  
100 lengths per case

<b>Art. No.: 3206 K</b>	iron brass-colour painted (khaki)
<b>Art. No.: 3206 K/3480</b>	iron brass-colour painted (khaki) lengths of 3480 mm
<b>Art. No.: 3206 M</b>	iron brass plated
<b>Art. No.: 3206 N</b>	nickel plated
<b>Art. No.: 3206 S</b>	stainless steel



### Slotted U-Rails

size: 6 x 16 x 0.6 x 3500 mm,  
distance of holes 98 mm  
100 pcs. per carton

<b>Art. No.: 11059</b>	brassed
<b>Art. No.: 11058</b>	nickel plated

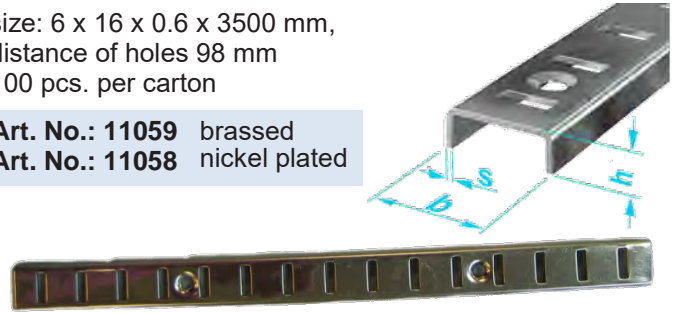

### Brackets, 16 mm for slotted U-Rails

300 pcs. per carton

<b>Art. No.: 11034</b>	brassed
<b>Art. No.: 11033</b>	nickel plated



### Threaded Rods

grad 4,8, zinc plated, DIN 975  
raw material: mild steel grade Q195/Q235,  
packed in bundles of abt. 20 kg

size (mm)	Art. No. 1 m length	Art. No. 2 m length	Art. No. 3 m length	Art. No. 4 m length
M 6	EGK M06x1MTRS	EGK M06x2MTRS	EGK M06x3MTRS	EGK M06x4MTRS
M 8	EGK M08x1MTRS	EGK M08x2MTRS	EGK M08x3MTRS	EGK M08x4MTRS
M 10	EGK M10x1MTRS	EGK M10x2MTRS	EGK M10x3MTRS	EGK M10x4MTRS
M 12	EGK M12x1MTRS	EGK M12x2MTRS	EGK M12x3MTRS	EGK M12x4MTRS
M 14	EGK M14x1MTRS	EGK M14x2MTRS	EGK M14x3MTRS	EGK M14x4MTRS
M 16	EGK M16x1MTRS	EGK M16x2MTRS	EGK M16x3MTRS	EGK M16x4MTRS
M 18	EGK M18x1MTRS	EGK M18x2MTRS	EGK M18x3MTRS	EGK M18x4MTRS
M 20	EGK M20x1MTRS	EGK M20x2MTRS	EGK M20x3MTRS	EGK M20x4MTRS
M 22	EGK M22x1MTRS	EGK M22x2MTRS	EGK M22x3MTRS	EGK M22x4MTRS
M 24	EGK M24x1MTRS	EGK M24x2MTRS	EGK M24x3MTRS	EGK M24x4MTRS



### Lead Sheets

made of Pb99,94 Cu, acc. to DIN 59610 EN 12588,  
packed in rolls of 50 kg, each 20 rolls on a pallet,  
wrapped with shrinkfoil, width 1000 mm

Art. No.	size (mm)	length (mm)
12.050	1.0	4400
12.062	1.5	2900
12.065	2.0	2200
12.068	2.5	1750
12.070	3.0	1500



# Spanning and Sealing Machines



## GEWA brand Spanning and Sealing Machines

body made of high-grade steel

### a) Model SIMPLEX I - incl. 1 knife only

Art. No.	range (inch - mm)
76170 0012	1/2 - 13
76170 0058	5/8 - 16
76170 0034	3/4 - 19



### b) Model SIMPLEX II - with 3 knives

Art. No.	range (inch)
76172 0000	1/2 - 5/8 - 3/4

## Model FAVORIT 100

- adjustable for 3 band width
- no-seal joint for steel strap
- can be used with all kind of high-quality steel bands
- thickness 0,5 mm, band guiding with ring marking

Art. No.	range (inch)
F100	1/2 - 5/8 - 3/4

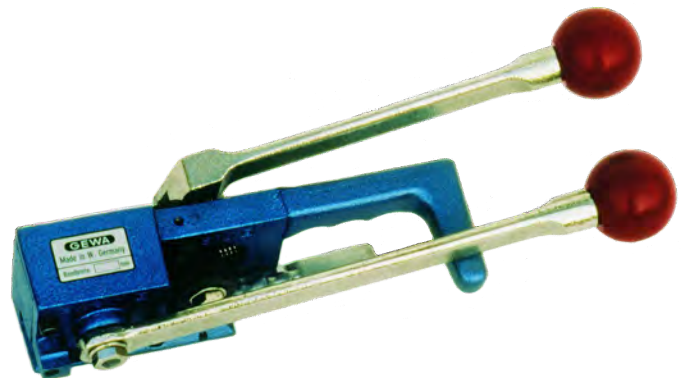

## Model FAVORIT 2000

- no-seal joint for steel strap
- can be used with all kind of high-quality steel bands
- thickness 0,38/0,60 mm

Art. No.	range (inch - mm)
F2000-13	1/2 - 13
F2000-16	5/8 - 16
F2000-19	3/4 - 19

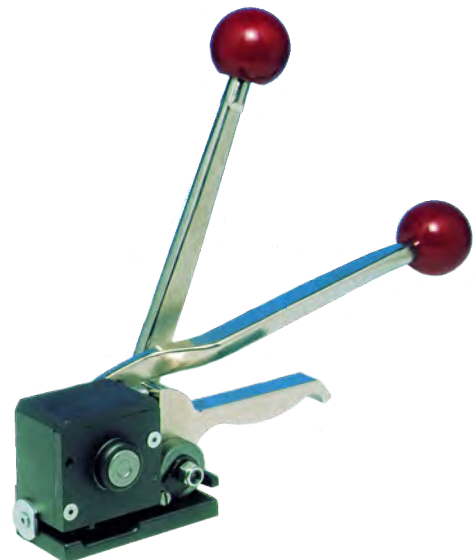

## Fixing Material

### Sealing Clips - Coppered Finish

length 25 mm, thickness 0,35/0,50 mm  
1000 pcs per box

Art. No.	size (inch/mm)
76175 2512	1/2 - 13
76175 2558	5/8 - 16
76175 2534	3/4 - 19



### Sealing clips - Iron Bright Finish

length 25 mm, thickness 0,50 mm  
1000 pcs per box

Art. No.	size (inch/mm)
76175 2512B	1/2 - 13
76175 2558B	5/8 - 16
76175 2534B	3/4 - 19

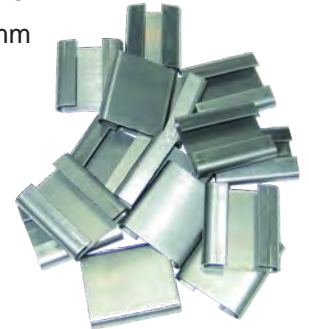

### Sealing Clips - Bright Galvanized Finish

size: 32 x 57 x 0,80 mm  
200 pcs per box

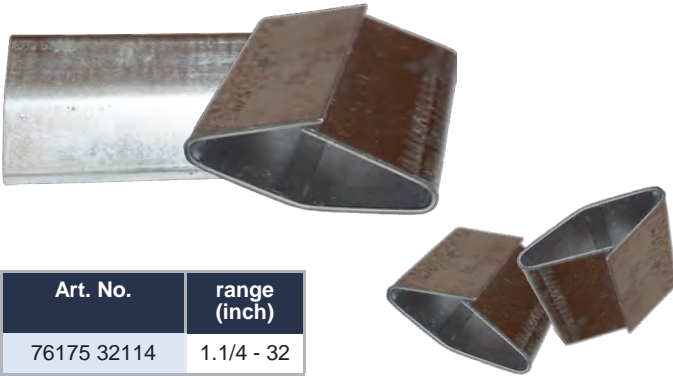

Art. No.	range (inch)
76175 32114	1.1/4 - 32

### Steel Straps

bright, cold-rolled,  
thickness 0,50 mm  
in rings of 15,0 kg  
2 rings each bundled

Art. No.	size (inch/mm)
76180 0012	1/2 - 13
76180 0058	5/8 - 16
76180 0034	3/4 - 19



### Lead Seals

Pb940R EN 12659

Art. No. in bags of 1 Kg	dia mm
753080	8
753100	10
753120	12
753140	14
753160	16



Art. No. in	dia mm
751100	10
751120	12

### Lead Sealing Pliers

with straight handles

- a) polished
- b) nickel-plated with blue coated handles



### Wire for Lead Seals on Spools

galvanized, size 0.50/0.30 mm

Art. No.	g / spool	meter / spool
1115030-05	250	96
1115030-06	500	193
1115030-07	1000	385



Art No. polished	Art No. w/blue handle	length (mm)	punch dia mm
25/0000	25/0000 bl	130	8.0
25/000	25/000 bl	150	9.0
25/00	25/00 bl	170	10.0
25/0A	25/0A bl	190	11.0
25/0B	25/0B bl	220	12.0

## Revolving Punch Pliers

### Revolving Punch Pliers - Bright, Nickel-plated

with additional hole diameter indicator, automatic lock function, exchangeable tubes Ø 2.0 - 4.5 mm, single packed in cardboard boxes, size: 225 mm / 9"



with plain handles

Art. No. **0910-3501(B)**



with red plastic coated handles

Art. No. **0910-3509(B)**

### Revolving Punch Pliers - Powder Coated

with additional hole diameter indicator, automatic lock function, exchangeable tubes Ø 2.0 - 4.5 mm, single packed in cardboard boxes, size: 225 mm / 9"



with blue hammer tone finish

Art. No. **0910-3504(B)**



red powder coated

Art. No. **0910-3505(B)**

### Lever Action Revolving Punch Plier

with additional hole diameter indicator, exchangeable tubes Ø 2.0 - 4.5 mm, bright, nickel-plated, with ergonomical shaped red plastic handle, single packed in cardboard

boxes, size: 250 mm / 10"

Art. No. **0930-3718(B)**



### Revolving Punch Plier - Powder Coated

with additional hole diameter indicator, automatic lock function, exchangeable tubes Ø 2.0 - 4.5 mm, single packed in cardboard boxes, size: 225 mm / 9"



black, with red plastic handles

Art. No. **0910-3508(B)**

### Revolving Punch and Eyelet Plier

automatic lock function, bright, nickel-plated, with ergonomical shaped red plastic handles, packed in cardboard boxes, size: 225 mm / 9"



with red plastic handles

Art. No. **0920-3601(B)**



## Industrial Cable Reels - BS



### KISTENMACHER Cable Reel

- cable reel body made of rust-resistant and galvanized steel
- with 3 x BS socket outlets 240 V with self-closing cover providing protection against dust and contamination
- ergonomic handle and axle for precision cable management when winding and unwinding
- with safety cut-out protection



Art. No.	cable	length	dia
1198057	H05VV-F 3G1,5	25 mtr	290 mm
1198067	H05VV-F 3G1,5	50 mtr	290 mm

*galvanized steel body*



### Garant Cable Reel

- cable reel body made of rust-resistant and galvanized steel
- with 3 x BS socket outlets 240 V with self-closing cover providing protection against dust and contamination
- ergonomic handle and axle for precision cable management when winding and unwinding
- with safety cut-out protection



Art. No.	Art. No.	cable	length	dia
1198057900	1198053	H05VV-F 3G1,5	25 mtr	240 mm
1198067900	1198063	H05VV-F 3G1,5	50 mtr	290 mm

Art. No.	extra heavy-duty cable	length	dia
1198113	H05VV-F 3G2,5	20 mtr	240 mm
1198093	H05VV-F 3G2,5	40 mtr	290 mm

*all types come with a galvanized steel tube frame and steel body*

#### available with:

- 3 x BS socket outlets only

or

- 3 x universal socket system, allows to plug-in BS, US and Euro / Schuko-Plugs



Art. No.	Art. No.	cable	length	dia
1218057900	1218053	H05VV-F 3G1,5	25 mtr	240 mm
1208067900	1208063	H05VV-F 3G1,5	50 mtr	290 mm

Art. No.	extra heavy-duty cable	length	dia
1208113	H05VV-F 3G2,5	20 mtr	240 mm
1208123	H05VV-F 3G2,5	40 mtr	290 mm

#### optionally available on request

with heavy duty 2,5 sqmm PVC cable (red colour)

- in order to avoid power drops, suitable for generators, high pressure cleaners, welding machines e.g.

*all types come with a break-resistant plastic body fitted to a galvanized steel tube frame*

## Industrial Cable Reels - BS

### Garant Bretec Cable Reel

with the unique Bretec anti cable twist system

- with 3 x BS socket outlets 240V with selfclosing cover providing protection against dust and contamination
- ergonomic handle and axle for precision cable management when winding and unwinding
- with safety cut-out protection



Art. No.	cable	length	dia
1198867	H05VV-F 3G1,5	50 mtr	290 mm



galvanized steel body

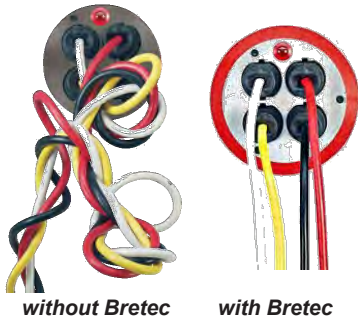

without Bretec

with Bretec

**NEW**  
CABLEPILOT

Art. No.	cable	length	dia
1208853	H05VV-F 3G1,5	25 mtr	240 mm
1208863	H05VV-F 3G1,5	50 mtr	290 mm



break-resistant plastic body



### Super-Solid Cable Reel

- extra stable steel tube frame with new, exclusive stability
- exceptional robust carry handle with comfortable cable guide
- galvanized steel tube frame
- with 3 x BS socket outlets 240V with self-closing cover providing protection against dust and contamination
- with safety cut-out protection
- ergonomic handle and axle for precision cable



Art. No.	cable	length	dia
1309453	H05VV-F 3G1,5	50 mtr	290 mm



galvanized steel body,  
galvanized frame



Art. No.	cable	length	dia
1308953	H05VV-F 3G1,5	50 mtr	290 mm



break-resistant plastic body,  
galvanized frame



## Industrial Cable Reels - BS

### Vario Line Cable Box

- housing made of break-resistant plastic
- practical carrying handle
- twin feet ensure excellent stability
- easy to wind and rewind
- with safety cut-out protection, 240 V

#### available with:

- 3 x BS socket outlets

or

- 3 x universal socket system, allows to plug-in BS, US and Euro / Schuko-Plugs

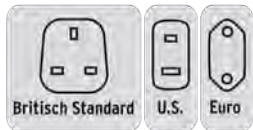

cable-management  
earthed sockets connected to separate phases



Art. No.	Art. No.	cable	length	colour
1098207900	1098203	H05VV-F 3G1,5	5 mtr	blue / black
1108567900	1108563	H05VV-F 3G1,5	10 mtr	blue / black
	1108903	H05VV-F 3G1,5	15 mtr	blue / black
	1093203	H05VV-F 3G1,5	10 mtr	black/black
	1094203	H05VV-F 3G1,5	15 mtr	black/black
	1108553	H05VV-F 3G1,0	10 mtr	grey / black
	1108203	H05VV-F 3G1,0	20 mtr	grey / black

### Primera-Line Cable Box

- compact design for comfortable handling
- with a universal handle for both carrying and hanging
- variable use, upright or flat
- robust, rigid construction
- with self-closing cover providing protection against dust and contamination
- with safety cut-out protection
- with 3 x BS socket outlets 240 V



Art. No.	cable	length	colour
1095453	H05VV-F 3G1,5	10 mtr	black /



**robust and rigid construction**

### Comfort Line Cable Box CL-S

- ergonomic design with a functional and practical rewind ring for easy handling
- with 3 x BS socket outlets 240 V
- with self-closing cover providing protection against dust and contamination
- with safety cut-out protection



Art. No.	cable	length	colour
1109123	05VV-F 3G1,25	3 mtr	black/white



Art. No.	cable	length	colour
1109233	05VV-F 3G1,5	3 mtr	black/blue
1109223	05VV-F 3G1,5	3 mtr	black/white



**break-resistant plastic body**



## Industrial Cable Reels - BS



### Compact Cable Reel AK 180

- reel body made from break-resistant plastic, galvanized frame
- portable and light - lots of cable taking up little space
- with safety cut-out protection
- ergonomic handle and axle for precision cable

#### available with:

- 3 x BS socket outlets or 3 x universal socket system, allows to plug-in BS, US and Euro-Plugs

Art. No.	Art. No.	cable	length	dia
1078187900	1078183004	H05VV-F 3G1,5	15 mtr	180 mm



break-resistant plastic body,  
galvanized frame

### Garant S Compact Cable Reel

- reel body made from rust-resistant and galvanised sheet steel fitted to a particularly sturdy galvanised steel tube frame
- with 3-way socket outlet 13 A BS with self-closing cover providing protection against dust and contamination
- ergonomic handle for comfortable carrying
- with thermal cut-out protection against overheating

Art. No.	cable	length	colour
1072933	H05VV-F 3G1,5	15 mtr	Black cable



### Rubber Cable Reel X-Gum

- compact and robust lightweight with integrated carrying handle
- reel body made of a special rubber mixture for long-term load bearing
- unbreakable, impact resistant, aging and weather resistant
- resistant to a variety of oils, greases, gasoline and acids, UV and ozone radiation
- 3 earthed sockets with self-closing covers
- with thermal cut-out protection against overheating

Art. No.	cable	length	colour
1169723150	H05VV-F 3G1,5	15 mtr	black



### Garant G Multi-Purpose Reel

- reel body made from special plastic, galvanized steel tube frame
- with BS rubber socket 240 V
- highly flexible cable with plug and trailing socket
- with cable guide handle für precision cable management
- with safety cut-out protection

Art. No.	cable	length	dia	plug
1141743015	H05VV-F 3G1,5	25 mtr	240 mm	BS



special Breflex plastic - blue colour  
galvanized steel tube frame





## Garant CEE Cable Reels



### Garant 400 V CEE 1 IP44

water-jet protected version for universal outdoor use

- 1 CEE-plug 400 V / 16 A
- 1 CEE socket 400 V / 16 A
- earthed sockets connected to separate phases
- reel body made from special Breflex plastic on a galvanized frame
- with 3-pin safety cut-out and thermal overload protection
- ergonomic handle and axle for precision cable management

available with 2-way 230V / 16A or 240V / 13A socket outlets with self-closing dust covers

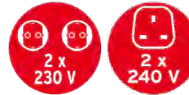

Art. No.	Art. No.	cable	length	dia
1237990	1182773	H07RN-F 5G2,5	20 mtr	320 mm
		<b>AT-N07V3V3-F 5G1,5</b> flexible, UV & Oil resistant	25 mtr	290 mm
1237980		H07RN-F 5G2,5	30 mtr	320 mm
1182720		H07RN-F 5G1,5	30 mtr	290 mm
1182730		H05VV-F 5G1,5	30 mtr	290 mm

special Breflex plastic, galvanized frame



### Garant 230 V CEE 2 IP 44

water-jet protected version for universal outdoor use

- 1 CEE-plug 230 V / 16 A
- 2 CEE sockets 230 V / 16 A
- reel body made from special Breflex plastic, on a galvanized frame
- with single pole safety cut-off and overheating protection
- ergonomic handle and axle for precision cable management



Art. No.	Art. No.	cable	length	dia
1193200	1193203	H07RN-F 5G2,5	25 mtr	320 mm

galvanized steel body and frame



### Garant 110 V CEE 2

for every requirement and use

- 2 CEE sockets 110 V / 16 A
- reel body made of special break resistant Breflex rubber
- robust, galvanized steel tube frame
- with cable guide handle für precision cable management
- with safety cut-out protection



Art. No.	Art. No.	cable	length	dia
1148773	1148853	H05VV-F 3G1,5	25 mtr	240 mm
1138873	1148863	H05VV-F 3G1,5	50 mtr	290 mm
1131953		H05VV-F 3G2,5	25 mtr	240 mm

special Breflex plastic, galvanized frame



with BRETEC anti twist cable system



## Industrial Cable Reels - Schuko brennenstuhl®



### KISTENMACHER Cable Reel

- cable reel body made of rust-resistant and galvanised steel
- with 4 x Schuko socket outlets with self-closing cover providing protection against dust and contamination
- ergonomic handle and axle for precision cable management when winding and unwinding
- with safety cut-out protection



Art. No.	cable	length	dia
1198067	H05VV-F 3G1,5	25 mtr	240 mm
1195067	H05VV-F 3G1,5	50 mtr	240 mm



galvanised steel body

### Garant Cable Reel

- with 4 x Schuko socket outlets with self-closing cover providing protection against dust and contamination
- ergonomic handle and axle for precision cable management when winding and unwinding
- galvanised steel frame
- with safety cut-out protection



Art. No.	cable	length	dia
1195056	H05VV-F 3G1,5	25 mtr	290 mm
1195066	H05VV-F 3G1,5	50 mtr	290 mm



galvanised steel body



Art. No.	cable	length	dia
1215056	H05VV-F 3G1,5	25 mtr	240 mm
1205066	H05VV-F 3G1,5	50 mtr	290 mm



break-resistant plastic body

### Garant Bretec Cable Reel

with the unique Bretec anti cable twist system

- with 4 x Schuko socket outlets with self-closing cover providing protection against dust and contamination
- ergonomic handle and axle for precision cable management when winding and unwinding
- with safety cut-out protection



Art. No.	cable	length	dia
1208850	H05VV-F 3G1,5	25 mtr	240 mm
1208860	H05VV-F 3G1,5	50 mtr	290 mm



break-resistant plastic body

The one has got a Bretec;  
the other's got a mess.

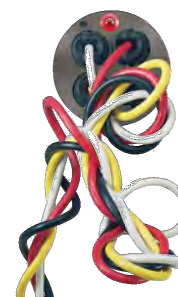

without Bretec

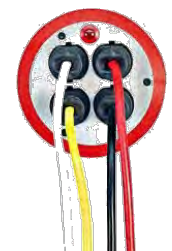

with Bretec

## Industrial Cable Reels - Schuko brennenstuhl®



### Vario Line Cable Box

- robust casing, made of special plastic
- with 4 x Schuko socket outlets
- practical carrying handle
- twin feet ensure excellent stability
- with safety cut-out
- with childproof sockets



black / grey    black / blue / grey    black / blue / grey    black / blue / grey

Art. No.	cable	length	colour
1092200	H05VV-F 3G1,5	5 mtr	black / grey
1093200	H05VV-F 3G1,5	10 mtr	black / grey
1093230	H05VV-F 3G1,5	10 mtr	black / blue / grey
1094200	H05VV-F 3G1,5	15 mtr	black / grey
1095450	H05VV-F 3G1,5	10 mtr	black / grey
1095650	H05VV-F 3G1,5	10 mtr	black / grey

with dust covers and illuminated



**break-resistant plastic body**

### Comfort Line Cable Box CL-S

- ergonomic design with a functional and practical rewind ring for easy handling
- with 4 x Schuko socket outlets
- with safety cut-out
- with childproof sockets



Art. No.	cable	length	colour
1109220	H05VV-F 3G1,5	3 mtr	black / white
1109230	H05VV-F 3G1,5	3 mtr	black / blue



**break-resistant plastic body**

### Compact Cable Reel

- reel body made from break-resistant plastic, galvanized steel tube frame
- with 4 x Schuko socket outlets
- portable and light - lots of cable taking up little space
- with safety cut-out protection
- with childproof sockets



Art. No.	cable	length	dia
1079180004	H05VV-F 3G1,5	15 mtr	180 mm



**break-resistant plastic body**

## Garant Garden Cable Reels brennenstuhl®



### Garant G Multi-Purpose Reel FP 20

- reel body made from special plastic, galvanized steel tube frame
- highly flexible cable with 16A schuko plug and trailing socket
- with cable guide handle für precision cable management
- with safety cut-out protection



Art. No.	cable	length	dia
1141740	H05VV-F 3G1,25	25 mtr	240 mm



**special plastic, galvanized frame**

### Garant G IP44 Garden Cable Reel with rewind system

- with 16 A Schuko plug and socket
- with cable pilot handle für precision cable management
- with safety cut-out protection
- extremely sturdy, very flexible to -35°C, UV- and oil resistant and extremely non-abrasive cable



Art. No.	cable	length	dia
1148370	<b>flexible, UV &amp; Oil resistant</b>	23 mtr	240 mm
1188470	<b>flexible, UV &amp; Oil resistant</b>	38 mtr	290 mm



**special BREMAXX plastic, galvanized frame**



## Extension cables

**Extension Cables - 240 V  
with rubberized socket 13 A**



Art. No.	PU	cable	length	colour	nomial current
1166553015	10	05VV-F 3G1,5	2 m	white	13A
1166563015	10	05VV-F 3G1,5	3 m	white	13A
1166573015	10	05VV-F 3G1,5	5 m	white	13A
1166503015	10	05VV-F 3G1,5	14 m	blue	13A
1166543015	10	05VV-F 3G1,5	25 m	blue	13A

**CEE Extension Cable IP 44, black  
for universal outdoor use and permanent use on sites, IP 44**

- ideal for hard outdoor use
- special rubber extension cable with CEE-socket and plug with cap



Art. No.	cable	cable quality	length	plug	socket
1 16771 0	H07RN-F 3G1,5	Rubber-Neoprene	10 m	CEE 400 V/16 A	CEE 400 V/16 A
1 16773 0	H07RN-F 3G1,5	Rubber-Neoprene	30 m	CEE 400 V/16 A	CEE 400 V/16 A

**Quality Plastic Extension Cables - SCHUKO Plug**



Art. No.	PU	cable	length	colour	nomial current
1168120015	10	H05VV-F 3x1,5	2 m	white	16 A
1165010015	10	H05VV-F 3x1,5	2 m	black	16 A
1 16843 0	10	H05VV-F 3x1,5	3 m	white	16 A
1 16543 0	10	H05VV-F 3x1,5	3 m	black	16 A
1 16844 0	10	H05VV-F 3x1,5	5 m	white	16 A
1 16544 0	10	H05VV-F 3x1,5	5 m	black	16 A

**Quality Plastic Extension Cables - SCHUKO Plug**



Art. No.	PU	cable	length	colour	nomial current
1 16846 0	5	H05VV-F 3x1,5	10 m	white	16 A
1 16746 0	5	H05VV-F 3x1,5	10 m	red	16 A
1 16546 0	5	H05VV-F 3x1,5	10 m	black	16 A
1 16747 0	4	H05VV-F 3x1,5	25 m	red	16 A
1 16548 0	4	H05VV-F 3x1,5	25 m	black	16 A
1 16147 0 (IP 44)	3	H05RR-F 3x1,5	25 m	black	16 A

**Extension Cables - CEE 110 V**



Art. No.	PU	cable	length	colour	nomial current
1166463	10	H05VV-F 3G1,5	14 m	yellow	110 V/16 A
1168463	10	H05VV-F 3G2,5	14 m	yellow	110 V/16 A

## Lighting Equipment



### Safety Inspection lamp

- the inexpensive quality inspection lamp
- with impact resistant, flexible basket
- with protective glass cover
- delivery without bulbs

Art. No.	cable	length	output	socket	plug
1 17646 0	H05RN-F 2x0,75	5 mtr	60 watt	E 27	Schuko



### Rubber Hand Lamp

- the approved, robust inspection lamp
- wire basket with caps
- with protective glass cover
- handle made of high quality hard rubber for comfort when in constant use
- supplied with Schuko plug
- delivery without bulbs

Art. No.	cable	length	output	socket	plug
1 17646 0	H05RN-F 2x0,75	5 mtr	60 watt	E 27	Schuko
1 17651 0	H05RN-F 2x0,75	10 mtr	60 watt	E 27	Schuko



### LED Automotive & Workshop Inspection Lamp IP 54

- 54 bright SMD LEDs with extremely long lifespan
- impact and break-proof protective tube with glare protection
- robust, ergonomically formed handle with 6 ribs to stop rolling away

- dust protected and splash proof, IP 54
- sturdy, swivel hook
- built in non replaceable lamp

**optional:** with built-in li-ion battery 3.7 V/3 Ah, charging time abt. 3,5 hrs, operating hrs abt. 3 hours (incl. 100-240 V AC, 50/60 Hz charger and 12-24V charger for car cigarette lighter)

Art. No.	cable	length	LEDs	colour temp	plug
1 17547 3	H05RN-F 2x1,0	5 mtr	54 SMD	6500 K	BS
1 17547 0	H05RN-F 2x1,0	5 mtr	54 SMD	6500 K	Schuko
1 17548 3	battery	-	54 SMD	6500 K	BS
1 17548 0	battery	-	54 SMD	6500 K	Schuko



### Inspection Lamp

- robust and impact-resistant
- ergonomically designed handle
- with electronic ballast in the handle
- hexagonal handle, prevents rolling away
- with large rotating hanging hook
- supplied with Schuko plug
- including lamp
- with or without ON/OFF switch

Art. No.	cable	length	output	plug
1 17711 0	H05RN-F 2x0,75	5 mtr	8 watt	Schuko
1 17723 0 with switch	H05VV-F 2x0,75	5 mtr	8 watt	Schuko



## ATEX Ex-Proof Rubber Hand Lamp IPX 5



- robust, handy inspection lamp with ergonomic handle
- hexagonal handle, prevents rolling away
- stable, galvanised wire basket for heavy use
- with protective glass resistant to sudden changes of temperatures
- glass no. 98 cover and anti-dazzle screen
- **test conformity II2G EExed IIAT3**
- delivery **without** cable and bulb

Art. No.	output	socket
439/GK	max. 60 watt	E 27



## LED Torches



### LuxPremium Focus-LED-Flashlight TL 100F IP 54

- very handy penlight with high luminosity
- with extremely bright 5W CREE-LED
- durable aluminium housing with clip
- dust protected and splash-proof, IP 54
- versatile and pocket-size
- in blister packing

100 Lumen  
5 W CREE-LED



Art. No.	LEDs	luminous flux	light duration
1 17860 0 051	5 W CREE	100 lm	5 h



### LuxPremium Focus-LED-Flashlight TL 250F IP 44

- with extra bright 5W CREE-LED for powerful light
- infinitely focus from laminary light to high beam focused light
- switch with soft touch function for 100% - 30% - SOS
- durable aluminium housing with wrist strap
- in blister packing

250 Lumen  
CREE-LED



Art. No.	LEDs	luminous flux	light duration
1 17860 0 161	CREE	250 lm	4 h



### LuxPrimera Focus LED Torch

- extreme bright LED Torch with new focus-technology
- continuous adjustable from a constant close light to a zooming distance light
- with new extra bright CREE POWER LED
- problem-free adjustable by one-hand operation
- 2 different settings and flashing function
- elegant, robust aluminium housing with wrist strap
- ON / OFF switch with soft-touch-function in „American Style“ at the end
- in blister packing

70 Lumen  
1 W CREE-LED

150 Lumen  
5 W CREE-LED



Art. No.	LEDs	luminous flux	light duration	battery type
1 17874 0	1 x 1 W CREE	70 lm	3,5 h	1 x AA (incl.)
1 17875 0	1 x 5 W CREE	150 lm	3,5 h	3 x AAA (incl.)

### LED Inspection Light Penlight HL 100 with clip and magnet 107+10lm

- 5 powerful LEDs with up to 6 hours of light ON time
- additional setting provides another LED in the lamp head
- clip with integrated magnet
- ON / OFF switch
- in blister packing, 10 pcs per package

107  
/10  
LUMEN



Art. No.	LEDs	luminous flux	colour temp.
1 17599 0 010	5 + 1	107 + 10 lm	7000 k

### SMD LED-Universal Lamp HL DB 81 M1H1

- 8 powerful LEDs with up to 4 hours of light ON time with full batteries
- additional setting provides another LED in the lamp head
- clip with integrated magnet turns 200° + 360° hanging hook
- 3 standard batteries AA included
- ON / OFF switch
- in blister packing



250  
+100  
Lumen



Art. No.	LEDs	luminous flux	colour temp.
1 17541 0 010	8 + 1	250 + 100 lm	6500 k

## LED Lamps



### 4 + 3 SMD LED-Universal Lamp HL DB 243 MH

- 4 super bright SMD LEDs on the front
- operation time approx. 6 hours with full batteries
- additional switching step for 3 x LEDs in the lamp head
- plastic handle with integrated magnet, 360° bendable
- 360° swivelled, retractable hanging hook
- with ON / OFF switch
- 3 standard batteries AAA included
- in blister packing

Art. No.	LEDs	luminous flux	colour temp.
1 17542 0 010	4 + 3	200 + 20 lm	6500 k



### 4 LED Rechargeable Hand Lamp HL DA 40 MH

- 4 super-bright SMD LEDs on the front with up to 3 hours of lighting when fully charged
- ON / OFF switch 100/50 %
- rubber-clad housing
- base foot with integrated magnet
- belt clip and 360° rotatable hook
- USB charging cable included
- in blister packing



Art. No.	LEDs	luminous flux	colour temp.
1 17644 0	4	220 + 100 lm	6000 k



### 6 + 1 LED Rechargeable Multi-Function Light

- two switching steps: 6 super-bright SMD LEDs on the front, 1 SMD LED in the lamp head
- USB charging port (charging cable included)
- folding base with integrated magnet
- 2 magnets on the back and 2 rotating hooks
- in blister packing



Art. No.	LEDs	luminous Flux	light duration
1 17567 0	6 + 1	300 + 100 lm	3 h / 10 h



### 4 + 1 LED Rechargeable Clip-on Lamp HL DA 41 MC

- 4 super-bright SMD LEDs on the front with up to 3,5 hours of lighting when fully charged
- Additional 1 CREE LED in the lamp head
- ON / OFF switch
- charging period approx. 3 hours
- clip with integrated magnet can be rotated 90°
- USB charging cable included
- in blister packing



Art. No.	LEDs	luminous Flux	light duration
1 17589 0	4 + 1	200 + 150 lm	3,5 h / 3,5 h

## Lighting

### LED Outdoor Light OLI 0200

small, variable and high-quality



- highly versatile for use in the house, in the garden, when camping and for outdoor activities
- non-blinding flood light
- switch with 3 different settings (100 - 50%, 10%, SOS)
- mounting options provided by 2 magnets and 2 hooks
- 9 pcs. delivered in an attractive sales box



Art. No.	LEDs	luminous flux	colour temperature	light duration
1 17155 0	12	max. 180 lm	4000 K	4 h / 8 h / 45 h

### Rechargeable LED Outdoor Light OLI 0300 A

compact, multifunctional and high-quality



- highly versatile for use in the house, in the garden, when camping and for outdoor activities
- very bright non-blinding light with additional spot, can be combined or used individually
- all lighting functions can be smoothly dimmed from 100 to 5%
- additional SOS and flashing function
- integrated Li-Pol rechargeable battery 3.7 V/3.0 Ah with charging indicator and integrated USB charging cable
- powerbank function: USB charging port for devices with USB charging cables such as smart phones, MP3 players, GPT, etc.
- mounting options provided by 2 magnets and 2 hooks



Art. No.	LEDs	luminous flux	colour temperature	light duration
1 17154 0	12+1 CREE	max. 180 lm	4000 K	4 h / 8 h / 45 h

### Rechargeable LED Hand Lamp SANSA 400 A

extremely slim lamp for tight spaces



- 12 super-bright SMD LEDs at front
- additional switching stage for a SMD-LED light in the head
- continuous dimming function 0 to 100% for particularly long lighting duration
- charging time about 3 hours
- rubber-clad housing
- bendable and rotatable lamp head, foldable to pocket format
- 2 magnets at the back, one in the holding foot and fold-out hook for flexible use
- integrated li-ion accumulator 3.7 V/2.0 Ah with charging indicator
- USB charging interface, including USB charging cable

Art. No.	LEDs	luminous flux	colour temperature	light duration
1 17737 0	12+1 LED	front: 400 lm spot: 70 lm	6000 K	3,5 h (100%) / 80 h (10%)



**LED Lamps and Walkie Talkies**

**Rechargeable LED Work Light RUFUS, Workshop Light Outdoor**

rechargeable work lamp for use indoors and outdoors, IP 65

- bright light, all the time even in areas without an electrical connection
- with integrated overcharge and total discharge protection and battery charging indicator
- with ON / OFF switch
- casing made of die-cast aluminium, edge protection made of high-quality plastic
- shockproof and drop-proof up to 3 m high, with edge protection
- stable, multi-stage, folding frame
- with a robust matching bag for safe transport
- USB charging cable included
- with power bank function for comfortable charging of e.g. Smartphones (charging connection type C)



Art. No.	luminous flux	light duration
1 17310 0 100	max. 1.500 lm	3 h (100%) / 6 h (50%)
1 17311 0 100	max. 3.000 lm	5 h (100%) / 6 h (50%)

**Rechargeable LED Work Light PF 1000 MA / LED Pocket Lamp outdoor (Camping Light)**

rechargeable work lamp for use indoors and outdoors, IP 65

- Extremely compact LED work light IP65 (dustproof and jet water protected)
- with fold-out bracket for setting up or convenient mounting on tripods from Brennenstuhl



Art. No.	luminous flux	light duration
1 17309 0 100	max. 1.000 lm	up to 13 h

**PMR Walkie-Talkie TRX 3500**

- communication up to a distance of 5km
- easy to use, small, handy and robust
- LC display with background lighting
- eight channels with automatic channel search
- four ring tones
- socket for headphone / microphone
- battery monitoring
- 8 AA batteries required per set (*not included*)

- in blister packing

Art. No.
1290940



## Head Lamps and LED-Lamps



### LuxPremium LED-Head Light

#### KL 100 IP 44

*Ultra light weight for comfort*



- 3 watt extra bright LED for powerful light
- robust and ultra light housing
- 3 switching levels and SOS function
- adjustable focus angle
- 2 standard batteries AA included
- in blister packing

Art. No.	LEDs	luminous flux	headlight range
1 17876 0	Toshiba-LED	100	40 mtr.

### LuxPremium LED-Head Light

#### KL 200F IP 44

*Ultra light weight for comfort*



- extra bright LED for powerful light
- front and rear lights
- robust and ultra light housing
- 4 switching levels and SOS function
- adjustable focus angle
- 3 standard batteries AA included

Art. No.	LEDs	luminous flux	headlight range
1 17878 0	CREE	200 lm	100 mtr.



### LuxPremium rechargeable

#### LED-Head Light KL 250



- extremely bright CREE LED at front with up to 30 h lightening duration
- 4 switching levels and SOS function
- rear light red/red flash functions
- adjustable focus angle
- exchangeable lithium-ion battery 3.7V/2,6Ah with charging indicator
- charging time 4 hours
- USB-cable included

Art. No.	LEDs	luminous flux	light duration	headlight range
1 17730 0	CREE	250 lm	5 h (100%) / 10 h(50%) 30 h(10%)	100 mtr.



### LED-Workshop lamp / Garage Work Light 12 SMD-LED

- LED worklight with 12 super bright SMD LED's with three lighting modes
- LED flashlight with integrated Li-Ion battery (3.7V/2.2 Ah) with charge indicator, including USB charging cable
- LED garage work light with integrated magnet in the base and stable rotating hook for fastening
- Rechargeable workshop light with ergonomic rubber handle and break-proof protective shell, ideal for use in workshop or garage

Art. No.	LEDs	luminous flux	light duration
1 17558 0	12 SMD	520 lm	Up to 24h



### LED Inspection lamp PL 200 A / Inspection Light with COB LED

- LED worklight with 200 lumens and a light duration of 12 h with 5 different lighting modes
- Handy, robust and flexible workshop lamp with on/off switch for powerful light in dark places thanks to high-quality COB LED
- The inspection light with COB LED and USB port can be attached to bags or belts thanks to practical clip, and can also be attached to metal surfaces thanks to magnet

Art. No.	LEDs	luminous flux	light duration
1 17558 0		520 lm	Up to 12h

## LED Lights & Tripods

### Mobile LED Light JARO

for indoor and outdoor use, IP 65

- LED light with ultra-bright SMD LEDs
- solid, modern aluminium housing
- robust steel tubular frame with protective plastic edges and ergonomically shaped plastic handle
- with safety glass



Art. No.	cable	length	power	luminous flux	lamp efficacy	plug
1 17125 3 233	H07RN-F 3G1,0	2 mtr	20 W	1870 lm	95 lm/W	BS
1 17125 3 343	H07RN-F 3G1,0	3 mtr	30 W	2930 lm	95 lm/W	BS
1 17125 3 533	H07RN-F 3G1,0	5 mtr	50 W	4770 lm	98 lm/W	BS
1 17125 3 833	H07RN-F 3G1,0	5 mtr	80 W	7200 lm	91 lm/W	BS



6500 K

### Tripod LED Light JARO

for indoor and outdoor use, IP 65

- LED light with ultra-bright SMD LEDs
- spotlight continuously adjustable and lockable
- solid, modern aluminium housing
- with safety glass
- telescope tripod made of stable tubular powder-coated steel
- handy and reliable tube clamping nuts
- with sturdy cable holder



6500 K

Art. No.	cable	length	power	LEDs	luminous flux	lamp efficacy	plug
1 17125 3 334	H07RN-F 3G1,0	5 mtr	30 W	44	2930 lm	95 lm/W	BS
1 17125 3 434	H07RN-F 3G1,0	2.5 mtr	2 x 20 W	2 x 28	2 x 1870 lm	95 lm/W	BS

# Hot Air Guns

**HL 1400 S**

- promotion type - starter model

**HL 1620 S**

- with two heating and airflow stages

Model	Art. No. (Schuko-Plug)	Art. No. (BS-Plug)	output (watt)	melt temp. (°C)	voltage	airflow rate	temp. setting
HL 1400 S	345914	n. a.	1400	300 / 500	220 - 230	in 2 steps	2-stage
HL 1620 S	351106	009632	1600	300 / 500	220 - 230	in 2 steps	2-stage

**HL 1920 E**

- electronically controlled hot air gun with temperature control and cool air stage

**HG 2320 E**

- electronically controlled hot air gun with continuously adjustable air flow and temperature control
- LCD display mode in 10°C steps

Model	Art. No. (Schuko-Plug)	Art. No. (BS-Plug)	output (watt)	melt temp. (°C)	voltage	airflow rate	temp. setting
HL 1920 E	352103	009649	2000	80 - 600	220 - 230	in 3 steps	9-stage
HG 2320 E	007386	009663	2300	80 - 650	220 - 230	in 2 steps	

**HL 2020 E**

- with LCD display
- microprocessor controlled hot air gun with temperature control and cool air stage

**HL 2020 E CASE**

- HL 2020 E with LCD display
- delivered in a case including 9 mm reduction nozzle

Model	Art. No. (Schuko-Plug)	Art. No. (BS-Plug)	output (watt)	melt temp. (°C)	voltage	airflow rate	temp. setting
HL 2020 E	008192	009656	2200	80 - 630	220 - 230	in 3 steps	in 10°C steps
HL 2020 E/Case	352202	012007	2200	80 - 630	220 - 230	in 3 steps	in 10°C steps

## Glue Guns

### GLUEMATIC 3002



- attractively priced glue gun
- electronically controlled with high melt capacity for diyers and professional users
- including 3 glue sticks

### SET GLUEMATIC 3002



- attractively priced glue gun
- electronically controlled with high melt capacity for diyers and professional users
- packed in PVC case, including 8 glue sticks

model	Art. No. (Schuko-Plug)	Art. No. (BS-Plug)	output (watt)	melt temp. (°C)	voltage
GLUEMATIC 3002	333317	330118	200	206	100 - 240
SET GLUEMATIC 3002	333393	n. a.	200	206	100 - 240

### GLUEMATIC 5000



- electronically controlled hot-melt glue
- applicator with a very high melting capacity for cordless glueing, including long and short nozzle

### SET GLUEMATIC 5000



- including standard and long nozzle and 8 glue sticks
- packed in PVC case

### GLUE STICKS



Glue Sticks suitable for a.m. models  
dia 11 mm, length 250 mm  
250 g / pack containing 10 pcs

Art. No.	colour
006761	Transparent, ULTRA POWER
006754	Transparent, CRYSTAL
006792	Black
006808	White
006778	Wood Application

model	Art. No.	output (Watt)	melt emp. (°C)	voltage
GLUEMATIC 5000	332716	500	210 - 220	220 - 240
SET GLUEMATIC 5000	332754	500	210 - 220	220 - 240

### Wireless Hot-Melt Glue Guns Neo 1 & Neo 2



NEO 1

NEO 2

- cordless operation with rechargeable lithium-ion battery 3,6 V
- incl. charging adapter with Schuko + Micro USB Plug
- run time up to 30 minutes
- automatic switch off
- warm up time less than 15 sec.
- NEW: gluing without dripping



Glue Sticks Neo  
dia 7 mm, length 150 mm  
suitable for different materials

Art. No.	weight	melt temp. (°C)	voltage
NEO 1 / 334109	155 gr.	170	100 - 240
NEO 2 / 334208	275 gr.	170	100 - 240

Art. No.	colour
006624	Transparent, CRYSTAL 96g
006594	Transparent, CRYSTAL 240g

## Voltage Tester

**KISTENMACHER** voltage tester will indicate the presence of voltage from 100 to 500V against earth.

### Voltage Tester – EGK VT140 / EGK VT200:

- 100-500 V
- with clip hanger
- in counter-top display box



Art. No.	A	B	C	weight / pc	pcs / display box	pcs / master carton	pcs / pallet
EGK VT140	3.5 mm	59 mm	140 mm	21.7 g	20 pcs	500 pcs	12000 pcs
EGK VT200	4.0 mm	115 mm	200 mm	34.3 g	20 pcs	500 pcs	9000 pcs

## Voltage and Car Light Testers

### Voltage Tester 100 - 500 V

with brass cap and clip



Art. No.	colour	length	carton
451 PM/k	clear	125 mm	600 pcs
451 PM/g	yellow	125 mm	600 pcs
452 PM/k	clear	140 mm	2400 pcs.
452 PM/g	yellow	140 mm	2400 pcs
457 PM/k	clear	190 mm	1200 pcs
457 PM/g	yellow	190 mm	1200 pcs

### Voltage Tester 100 - 500 V

with brass cap



### Voltage Tester 100 - 500 V

with plastic cap and clip



Art. No.	colour	length	carton
451 P/k	clear	125 mm	600 pcs
451 P/g	yellow	125 mm	600 pcs
452 P/k	clear	140 mm	2400 pcs
452 P/g	yellow	140 mm	2400 pcs

### Euro Voltage Tester 125 - 250 V

with plastic clip



Art. No.	colour	length
45300P/b	blue	150 mm
45800P/b	blue	190 mm
45300P/o	orange	150 mm
45800P/o	orange	190 mm



Art. No.	colour	length
45400P/r	red	150 mm
45900P/r	red	190 mm

Voltage Testers are also available on KISTENMACHER display hanger



### Car Light Tester 6 - 24 V

with cable and crocodile clip



Art. No.	version	length
4598 A	brass	120 mm



Art. No.	colour	length
4568 A	yellow	120 mm

### Car Light + Spark Plug Tester Set 6 - 24 V

with cable and crocodile clip,  
in single plastic wallets  
including Art. No. 4568A + 4568Z



### Spark Plug Tester



Art. No.	colour	length
4568Z	yellow	120 mm

Art. No.	colour	length
4518 ZA/T	yellow	120 mm

# Electronic Voltage Tester



## Volt Check 3.1 IP 40

Art. No.	range	display
991895	6-400V AC/DC	LED



## Master Check battery powered, IP 65

Art. No.	range	display
991888	6-400V AC/DC	LED



## Combi Check battery powered, IP 65

Art. No.	range	display
991886	6-690V AC/DC	LED



## Combi Check PRO battery powered, IP 65

Art. No.	range	display
127933	6-690V AC/DC	LED



## Multi Check battery powered, IP 65

Art. No.	range	display
991892	5-500V AC/DC	LCD



## Digi Check battery powered, IP 65

Art. No.	range	display
991885	5-690V AC/DC	LCD



## Digi Check PRO battery powered, IP 65

Art. No.	range	display
991887	5-690V AC/DC	LCD



# Detectors



## Electronic Multi Tester MT 6 S/2



- non-contact location of cables with AC voltage
- checking phase, neutral and earthing conductor at the sockets
- continuity check, e.g. of fuses, bulbs etc.
- polarity check, e.g. of batteries
- display through the LED
- small and handy
- can be used as a torch because of the super-bright LED
- inclusive 3 replaceable coin cells



Art. No.	packing
1 29715 0	5 pieces

## Moisture Detector MD



- to determine the moisture content of wood building material, such as e.g. concrete, brick, screed, plasterboard, wallpaper etc
- measuring range of 5-50% for wood, or 1,5-33% for building material
- large LCD display (resolution 0,1%) as well as acoustically
- practical hold function also makes measurement possible at locations difficult to access
- automatic switch-off appr. 3min after last application
- battery low voltage display
- robust, ergonomic housing with separate compartment for 9V monobloc battery (not included)
- with protective cap

Art. No.	packing
1 29868 0	1 piece

## Multifunction Detector WMV Plus metal/voltage/beam detector



- for locating metal, voltage carrying cables (AV voltage) and wooden beams e.g. in walls
- 3 functions on one appliance, functions can be individually applied
- accurate display of the result on large LCD display
- automatic sensitivity control
- battery compartment for 9V block (battery not included)
- automatic switch-off after end of measurement
- battery low voltage display
- maximum detection: wood up to 40mm, AC voltage appr. 30-50mm, metal appr. 50-80mm
- user friendly through the operation button on the side and front.

Art. No.	packing
1 29818 0	1 piece



## Soldering & Welding



### Soldering Irons for Plumbers

with wooden handle

#### Type No. 1 - Hammer Head



#### Type No. 4 - Taper Head

Art. No.	weight (g)	Art. No.	weight (g)
1/100	100	1/350	350
1/125	125	1/400	400
1/150	150	1/500	500
1/175	175	1/600	600
1/200	200	1/700	700
1/225	225	1/800	800
1/250	250	1/900	900
1/300	300	1/1000	1000

### Electric Soldering Irons

with wooden handle

- with 2 core cable and euro plug, 230V, 50/60 cycles

- with 3 core cable and BS-plug 13A, 230-240V, 50/60 cycles



#### Lightweight model



#### Heavy duty model



Art. No.	power	Art. No.	power	Art. No.	power
099/2D	40 Watt	121/2D	100 Watt	099/3D BS	40 Watt
100/2D	50 Watt	122/2D	125 Watt	101/3D BS	60 Watt
101/2D	60 Watt	130/2D	150 Watt	120/3D BS	75 Watt
120/2D	75 Watt	132/2D	200 Watt	121/3D BS	100 Watt
				130/3D BS	150 Watt
				132/3D BS	200 Watt

Art. No.	power	Art. No.	power
151/2D	250 Watt	151/3D BS	250 Watt
152/2D	300 Watt	152/3D BS	300 Watt
154/2D	400 Watt	154/3D BS	400 Watt
156/2D	500 Watt	156/3D BS	500 Watt

### STANNOL Soldering Irons

with plastic handle, cable length approx. 1,5 m and safety plug (230 V), packed in individual carton



Art. No.	usage	power	tip temp (approx. °C)
750100	for electronics soldering	15 Watt	370
750300	for soldering in radio and telecommunication work	30 Watt	410
750600	for use in electrical installation and work involving fine wires and metal sheets	60 Watt	460
750800	for metal sheets soldering and general workshop operation	80 Watt	480
751000	for coarse soldering work in handicraft	100 Watt	500
751500	for workshop and factory, seam soldering on fine metal sheets	150 Watt	510
752000	for workshop and factory, seam soldering on metal sheets up to 1.0 mm thickness	200 Watt	530

## Soldering & Welding

### Soldering Set SK 3000

suitable for universal soldering capacity, in practical storage case

contents:

- soldering gun 100W + replacement tip
- soldering iron 30W incl. soldering stand
- de-soldering pump
- soldering aid tool
- solder wire in dispenser tube, 20 g
- helping hand



Art. No.	description
206439	soldering Set SK 3000

### STANNOL Soldering Guns

protection class II - double insulated, ready for soldering within 5 sec. (230 V)

Art. No	power	colour
206430-W90	60 Watt	black colour in blister packing
206460-EP75	75 Watt	blue colour in blister packing
206786-EP100	100 Watt	black colour in blister packing



### STANNOL Woodburning Pen 30WBC

with different colours

- power supply 230V
- with soldering iron stand
- 7 woodburning tips: star, windmill, square, triangle, wheel, stripe, dart board
- 6 water colours: white, black, blue, brown, red, yellow + paint brush

Art. No	power
274006	30 Watt



### Sal ammoniac in blocks

for cleaning of soldering tips

Art. No.	description	PU	size (mm)
27100001	Stone No. 1	300 pcs	65 x 45 x 20
27100002	Stone No. 2	150 pcs	65 x 45 x 40
27100004	Stone No. 4	100 pcs	app. 100 x 50 x25 in plastic jar
27100005	Stone No. 5	100 pcs	200 x 45 x 40
27100008	Stone No. 8	200 pcs	100 g in can



# Soldering & Welding



## Soldering Wire - RA

for soldering onto metals, tins, brass, cans, batteries, not suitable for soldering involving electrical engineering and electronic applications



### Alloy - S-PB70Sn30 on spools

Ø (mm)	1.0 mm	1.5 mm	2.0 mm	3.0 mm
100 g	18321010	18321510	18322010	18323010
250 g	18321020	18321520	18322020	18323020
500 g	18321030	18321530	18322030	18323030
227 g	18321017	18321517	18322017	18323017
454 g	18321027	18321527	18322027	18323027

### Alloy - S-PB60Sn40 on spools

Ø (mm)	1.0 mm	1.5 mm	2.0 mm	3.0 mm
100 g	18401010	18401510	18402010	18403010
250 g	18401020	18401520	18402020	18403020
500 g	18401030	18401530	18402030	18403030
227 g	18401017	18401517	18402017	18403017
454 g	18401027	18401527	18402027	18403027

### Alloy - S-PB50Sn50 on spools

Ø (mm)	1.0 mm	1.5 mm	2.0 mm	3.0 mm
100 g	18501010	18501510	18502010	18503010
250 g	18501020	18501520	18502020	18503020
500 g	18501030	18501530	18502030	18503030
227 g	18501017	18501517	18502017	18503017
454 g	18501027	18501527	18502027	18503027

### Alloy - RA 70/30/H4 on spools

Ø (mm)	1.0 mm	1.5 mm	2.0 mm
100 g	1821101092	1821151092	1821201092
250 g	1821102092	1821152092	1821202092
500 g	1821103092	1821153092	1821203092
227 g	1821101792	1821151792	1821201792
454 g	1821102792	1821152792	1821202792

## Soldering Wire ISO-Core - SP

### Flux-cored soft solder wire acc. to DIN EN ISO 9453

for general soldering of copper and copper base alloys



### Alloy - S-PB70Sn30 on spools

Ø (mm)	1.0 mm	1.5 mm	2.0 mm	3.0 mm
100 g	15321010	15321510	15322010	15323010
250 g	15321020	15321520	15322020	15323020
500 g	15321030	15321530	15322030	15323030
227 g	15321017	15321517	15322017	15323017
454 g	15321027	15321527	15322027	15323027

### Alloy - S-PB60Sn40 on spools

Ø (mm)	1.0 mm	1.5 mm	2.0 mm	3.0 mm
100 g	15401010	15401510	15402010	15403010
250 g	15401020	15401520	15402020	15403020
500 g	15401030	15401530	15402030	15403030
227 g	15401017	15401517	15402017	15403017
454 g	15401027	15401527	15402027	15403027

### Alloy - S-PB50Sn50 on spools

Ø (mm)	1.0 mm	1.5 mm	2.0 mm	3.0 mm
100 g	15501010	15501510	15502010	15503010
250 g	15501020	15501520	15502020	15503020
500 g	15501030	15501530	15502030	15503030
227 g	15501017	15501517	15502017	15503017
454 g	15501027	15501527	15502027	15503027

### Alloy - SP 70/30/H4 on spools

Ø (mm)	1.0 mm	1.5 mm	2.0 mm
100 g	1521101092	1521151092	1521201092
250 g	1521102092	1521152092	1521202092
500 g	1521103092	1521153092	1521203092
227 g	1521101792	1521151792	1521201792
454 g	1521102792	1521152792	1521202792

## Soldering & Welding



### Soldering Paste (Grease)

flux for general soft soldering to copper and copper base alloys  
DIN 29454-1, 3.1.1.C (F-SW 21)



Art. No.	size
243100351	50 g
243100501	100 g
243100551	250 g

### Aluminium welding Powder

in PVC-tins  
for welding thick aluminium sheets



Art. No.	size
26420050	100 g
26420055	250 g
26420060	500 g
26420070	1000 g

### Aluminium welding/soldering Powder „Nr. 1“

DIN EN 1045 FL 10  
for hard soldering and welding of aluminium and aluminium base alloys



Art. No.	size
26400050	100 g
26400055	250 g
26400060	500 g
26400070	1000 g

### Soldering Liquid

flux for general soldering to all metallic surfaces except aluminium and stainless steel  
DIN EN 29454.1, 3.1.1.A (F-



Art. No.	size
24220051	100 ml
24220056	250 ml
24220061	500 ml
24220071	1000 ml

### Hard solder Powder „UNIVERSAL“

for hard soldering of brass, copper, copper base alloys and steel  
DIN EN 1045-FH21



Art. No. Felder	Art. No. Stannol	size
26200050		100 g
26200055	142030	250 g
26200060	142028	500 g
26200070		1000 g

### Strengthening powder for hardening of steel

nitrogen-hardening powder for hardening of iron and unalloyed steel



Art. No.	size
26510060	500 g
26510070	1000 g

## Soldering & Welding



### Soldering Paste - Silver Solder

fluxing paste for brazing brass - DIN EN 1045 - FH 10



Art. No.	size
26100050	100 g
26100055	250 g
26100060	500 g

### Hard Solder Paste

for hard soldering of copper, copper base alloys and steel as well as welding of brass - DIN EN 1045 FH 21



Art. No.	size
26250050	100 g
26250055	250 g
26250060	500 g
26250070	1000 g

### Soft Soldering Bars - Triangular

packed in cartons of 25 kgs

Art. No	version	alloy
1215012092	30/70/H3 - Export	L-Pb85Sn15Sb
1221012094	40/60/H4 - Export	L-Pb78Sn20Sb2
1231012095H	50/50H6 - Export	L-Pb70Sn30
12310120	standard quality	S-Pb70Sn30
12410122	standard quality	S-Pb60Sn40
12510120	standard quality	S-Pb50Sn50
1299120	standard quality	L-Sn99,9 (Pure tin)



### Brass Welding Rods

in length of 1 mtr., packed in bundles of 10 kg, each bundle packed in plastic foil, 10 bundles per case



Ø (mm)	2.0	2.5	3.0	3.2	4.0
SMS 60 - L-CuZn40 - hard type	75630 0020	75630 0025	75630 0030	75630 0032	75630 0040
MS 63 - CuZn37 - flexible type	MS 63/2	MS63/2,5	MS63/3	MS63/3.2	MS63/4

## Welding Electrodes

### Cast-Iron Electrodes GRICAST 6

Ni/Cu welding electrodes for welding cast iron, according to AWS A 5.15

Art. No.	size (mm)	weight (kg/box)
99892530	2.5 x 300	3.8
99893235	3.2 x 350	4.5
99894040	4.0 x 400	5.0



### Welding Stick Electrodes CONARC 49

for shipbuilding and light general construction work, according to AWS A5.1, E 7018 H44, ISO 2650-A



Art. No.	size (mm)	weight (kg/box)
609266	2.5 x 350	4,5
609267	3.2 x 350	4,5
609268	4.0 x 350	5,0
609270	5.0 x 450	6,7

### SUPERGLAZE MIG-4043

wire electrodes for aluminium alloys, used for welding of automotive components like frame and drive shafts, bicycle frames according to AWS A5.10/5.10M, ER 4043, ISO 18273

Art. No.	Ø (mm)	weight (kg/spool)
701753	1,0	7,0
701754	1,2	7,0



### GRILUMIN 14 Welding Electrodes

for aluminium alloys, used for marine constructions and repairing cast aluminium, bodies and components of pumps, electric motor housings etc., according to AWS A5.3-91, E 4043

Art. No.	size (mm)	weight (kg/tin)
803204	3.2 x 350	2.0



### SUPERGLAZE MIG-5356

wire electrodes for aluminium alloys, used for welding of structural frames in shipbuilding, furniture, storage tanks, railway, automotive and trailer industry according to AWS A5.105.10M, ER 5356, ISO 18273

Art. No.	Ø (mm)	weight (kg/spool)
701762	0,8	7,0
701763	1,0	7,0
701764	1,2	7,0
701765	1,6	7,0



## Welding Rods and Sticks

### Welding Stick Electrodes HILCO BASIC

for shipbuilding and light general construction work,  
E 7018-1

Art. No.	size (mm)	weight (kg/box)
61818	3.2 x 350	5,8
61819	4.0 x 450	4,3



### Aluminum Welding Sticks

HILCO ALUMINIL Si5 Welding Sticks E 4043-aluminium,  
EN ISO 18273 - AWS A 5.3  
packed in alu cans of 2.0 kg



Art. No.	size (mm)	weight (kg/can)
66517	3.2 x 350	2.0
66677	2.5 x 350	2.0

### Welding Electrode Rods

HILCO Aluminium AlSi5 Welding Electrode Rods ER 4043  
EN ISO 18273 - AWS A 5.10  
packed in cartons of 5.0 kg



Art. No.	size (mm)	weight (kg/box)
75190	1.6 x 1000	5.0
75191	2.0 x 1000	5.0
75947	2.4 x 1000	5.0
75192	3.2 x 1000	5.0

### Nickel Iron Stick Electrodes

HILCO Nickel Iron Stick Electrodes, ENiFe-Ci,  
packed in packs of 1.0 kg  
EN ISO 1071 AWS-standards A5.15



Art. No.	size (mm)	weight (kg/box)
70403	3.2 x 350	1.0

### Welding Electrode Rods

HILCO AL Mg5 Welding Electrode Sticks ER 5356  
EN ISO 18273: S Al 5356 (AlMg5Cr(A)) - AWS A 5.10  
packed in cartons of 5.0 kg



Art. No.	size (mm)	weight (kg/box)
78218	1.6 x 1000	5.0
77940	2.0 x 1000	5.0
77019	2.4 x 1000	5.0
66658	3.2 x 1000	5.0

## Safety Equipment

### Welding Goggles

traditional welding goggles with a flip up mechanism for the shaded welding glasses, indirect ventilation as well as easy replacement of lenses with screw-on construction. With adjustable headband for comfortable fit.

Art. No.	shade	colour	lens
172200105	clear	yellow	50 mm



### Safety Welding Goggles Model 879

Art. No.	shade	colour	lens
187902740	clear	black	50 mm
187902106	6	black	50 mm



### Dark Welding Glasses

DIN 4646/4647

available sizes:

- 50 x 105 mm
- 50 x 108 mm
- 51 x 108 mm

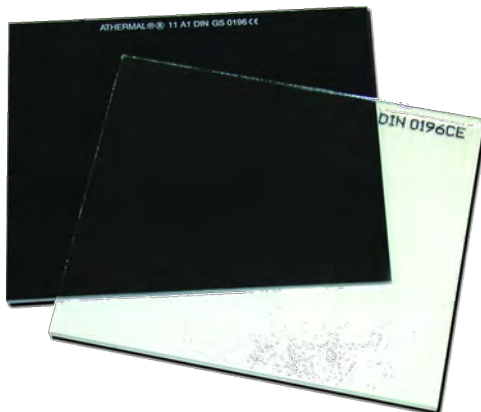

Art. No.	shade
50105/9	9
50105/10	10
50105/11	11
50105/12	12

Art. No.	shade
50108/9	9
50108/10	10
50108/11	11
50108/12	12

Art. No.	shade
51108/9	9
51108/10	10
51108/11	11
51108/12	12



### Heavy Duty Electrode Holders

with pressure ring, brass version, 60 % duty cycles

Art. No.	amp	sqmm
512.D255	200	25/35
512.D256	300	35/50
512.D257	400	50/70
512.D258	500	70/95
512.D259	600	70/95



### Welding Electrode Holders

- export version - fully insulated, black

Art. No.	amp
3102-300	300
3102-400	400
3107-500	500
3107-600	600



### Earth Clamps for Welders

with cable-shoe connection

Art. No.	amp
4165	300
4166	400
4167	600



### Earth Clamps for Welders

with cable-shoe connection

Art. No. male-plug	Art. No. female-socket	size (sqmm)
511.0005	511.0003	10-25
511.0015	511.0013	35-50
511.0031	511.0029	50-70
511.0042	511.0040	70-95





## Safety Equipment

### Protective Hand-Shields Type EURO-STAR

thermostable up to 100° C - straight, made of black ABS material, complete with lens frame and handle

Art. No.	Glass size
21400A	51 x 108 mm
21400	90 x 110 mm



### Protective Hand-Shields Type EURO-HANDY 2000

thermostable up to 120° C - inclined

Art. No.	Glass size
200100A	51 x 108 mm
200100	90 x 110 mm



### Welding Helmets Type EURO

a) made of black ABS material, complete with lens

Art. No.	Glass size
219400A	51 x 108 mm
219400	90 x 110 mm



### Welding Helmets Type EURO

b) fibre-glass reinforced

Art. No.	Glass size
219411A	51 x 108 mm
219411	90 x 110 mm



### Ear Protection

around hearing protector - headband with head cushion

- weight: 200 g
- Made in Germany

Art. No.
3001 L STAR



### SONICO 2000

- ear protectors with padded and adjustable headpiece
- the ear muffs are made of high-grade, impact-resistant polycarbonate
- the parts are easy to clean and replace
- in polybag packing

Art. No.	colour
0601 000 08	orange



# Marking Material, Hose Clips & Fixing Material



## THREE STARS brand Marking Crayons

size: 12 x 120 mm  
1 dozen in a carton box

Art. No.	colour
12012-1	white
12012-2	yellow
12012-3	red
12012-4	green
12012-5	black



## LYRA brand Marking Crayons

size: 11 x 110 mm  
1 dozen in a carton box

Art. No.	colour
795001	white
795007	yellow
795017	red
795051	blue
795067	green
795099	black



## NORMA brand Hose Clips TORRO

in carton box packing

- a) W1 width 12 mm
- b) W1 width 9 mm



range mm	Art. No. width 12 mm
16-27	W1/16-27/12
20-32	W1/20-32/12
25-40	W1/25-40/12
30-45	W1/30-45/12
35-50	W1/35-50/12
40-60	W1/40-60/12
50-70	W1/50-70/12
60-80	W1/60-80/12
70-90	W1/70-90/12
80-100	W1/80-100/12
90-110	W1/90-110/12
100-120	W1/100-120/12
110-130	W1/110-130/12
120-140	W1/120-140/12
130-150	W1/130-150/12
140-160	W1/140-160/12
150-170	W1/150-170/12
160-180	W1/160-180/12
180-200	W1/180-200/12
200-220	W1/200-220/12

range mm	Art. No. width 9 mm
8-12	W1/8-12
10-16	W1/10-16
12-18	W1/12-18
12-22	W1/12-22
16-27	W1/16-27
20-32	W1/20-32
25-40	W1/25-40
30-45	W1/30-45
35-50	W1/35-50
40-60	W1/40-60
50-70	W1/50-70
60-80	W1/60-80
70-90	W1/70-90
80-100	W1/80-100
90-110	W1/90-110

## Steel Collars for Light Pipes

band size 16 x 1.2 mm,  
thread M6, bulk packing 100 pcs

Art. No.	pipes for mm	type
1402	14	CT14
1403	16	CT16
1404	18	CT18
1405	20	CT20
1406	22	CT22
1407	24	CT24
1408	26	CT26
1409	28	CT28



## Steel Collars

screw with threaded steel, with  
wall plug, blister packing

4 + 4 + 4 pcs / pack

Art. No.	pipes for mm	type
3191	14	CTV14.S
3192	16	CTV16.S
3193	18	CTV18.S
3194	20	CTV20.S
3195	22	CTV22.S
3196	24	CTV24.S

3 + 3 + 3 pcs / pack

Art. No.	pipes for mm	type
3197	26	CTV26.S
3198	28	CTV28.S



# Fixing Materials



## Fixing Sets

in poly bag packing

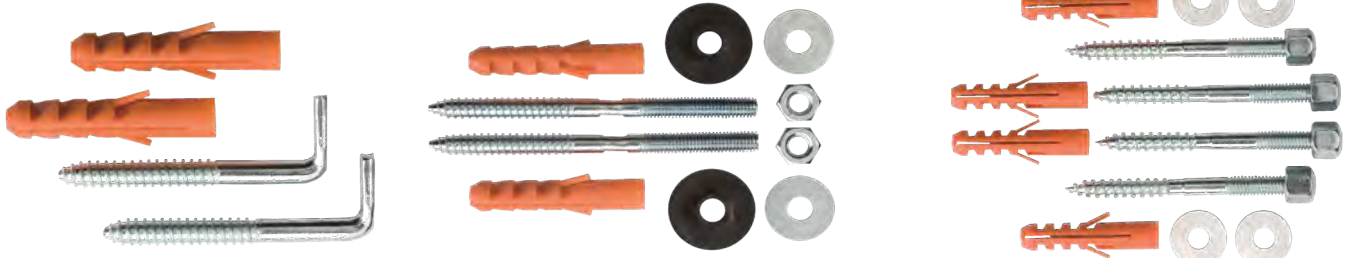

### for Water Boilers

Art. No.	size (mm)
5771 00 1095 1	10 x 95

### for Wash Basin

Art. No.	size (mm)
5772 10 0140 1	10 x 140

### for WC and Bidet

Art. No.	size (mm)
5773 04 6070 1	6 x 70
5773 04 6090 1	6 x 90

## Mirror Clamps Sets

4-piece, with 2 upper parts and 2 lower parts and 4 screws

steel nickel-plated, in poly bag packing

**Art. No. 6503 GE 0000 2**

stainless steel, with additional 4 wall plugs, in carton packing

**Art. No. 6503 SS 0000 2**



## Mirror Caps

with 1/8" threaded pin

pointed

rounded



Art. No.	Ø (mm)
348/12	12
348/16	16
348/19	19
348/24	24

Art. No.	Ø (mm)
349/10	10
349/13	13
349/15	15
349/18	18
349/20	20
349/24	24

## Iron Screws

with inner thread 1/8" specially made for mirror caps, steel galvanized, Ø 4.5 mm



Art. No.	length (mm)
357/15	15
357/20	20
357/25	25
357/30	30
357/35	35
357/40	40
357/50	50
357/60	60
357/70	70
357/80	80

## VITOMOUNT Mirror Tapes

colour: white, two side-adhesive, in rolls of 66 m, 13 pcs per carton

thickness 6 mm, covered with green silicon-foil, 25 x 1 mm

**Art. No. 125-SS-70 PE**

thickness 8 mm, covered with brown silicon-foil, 19 x 1 mm

**Art. No. 125-SS-70 PBR**



## Fixing Materials

### Wall Plugs

Expandet brand  
in carton packing,  
packing unit: 100 pcs



Art. No.	size (mm)	length (mm)	colour
1204251	4.0	25	yellow
1205251	5.0	25	white
1205351	5.0	35	white
1206251	6.0	25	red
1206351	6.0	35	red
1207251	7.0	25	green
1207301	7.0	30	green
1207351	7.0	35	green
1207501	7.0	50	green
1208251	8.0	25	blue
1208351	8.0	35	blue
1208501	8.0	50	blue
1210351	10.0	35	orange
1210501	10.0	50	orange
1210601	10.0	60	orange
1212501	12.0	50	grey
1212601	12.0	60	grey
1212751	12.0	75	grey

### KISTENMACHER brand Wall Plugs

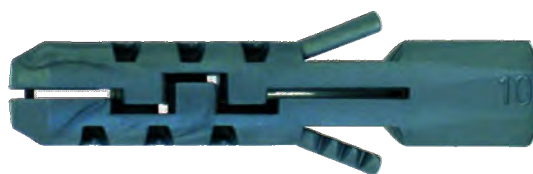

Art. No.	size (mm)	pcs/box
260240	4.0 x 20	100
260525	5.0 x 25	100
260630	6.0 x 30	100
260840	8.0 x 40	100
261050	10.0 x 50	50
261260	12.0 x 60	25
261470	14.0 x 70	20
261680	16.0 x 80	15
262090	20.0 x 90	10

### KISTENMACHER brand Expansion Shield

is suitable for fixing of heavy objects in concrete and solid brick. Used with set screw, threaded rod, bolts, etc.



Art. No.	size (mm)	packing
4x32/EGK	4 x 32	10 pcs per bag
4x45/EGK	4 x 45	10 pcs per bag
5x52/EGK	5 x 52	10 pcs per bag
5x65/EGK	5 x 65	6 pcs per bag

### KISTENMACHER brand Metal Cavity Anchor Sets



Art. No.	size (mm)	packing
4x32/EGK	4 x 32	10 pcs per bag
4x45/EGK	4 x 45	10 pcs per bag
5x52/EGK	5 x 52	10 pcs per bag
5x65/EGK	5 x 65	6 pcs per bag
6x52/EGK	6 x 52	6 pcs per bag
6x65/EGK	6 x 65	6 pcs per bag

### Expandet brand Chemical Anchors



Art. No.	size	length
900008	8	80
900010	10	80
900012	12	95
900016	16	92
900020	20	170
900024	24	210

## Fixing Materials

### KISTENMACHER brand Assortment Boxes (300 pcs per box)

several assortments of wall plugs, pan head and countersunk screws.

#### a) Countersunk PZ

**Art. No. 28568-A/EGK**

containing screws:

- 60 pcs 3.5 x 30 mm
- 60 pcs 4.5 x 40 mm
- 30 pcs 6.0 x 50 mm

containing wallplugs:

- 60 pcs 5 x 25 mm
- 60 pcs 6 x 30 mm
- 30 pcs 8 x 40 mm

#### b) Pan Head PZ

**Art. No. 28568-B/EGK**

containing screws:

- 60 pcs 3.5 x 30 mm
- 60 pcs 4.5 x 40 mm
- 30 pcs 6.0 x 50 mm

containing wallplugs:

- 60 pcs 5 x 25 mm
- 60 pcs 6 x 30 mm
- 30 pcs 8 x 40 mm

#### c) MIX 50/50 PZ

**Art. No. 28568-C/EGK**

containing countersunk screws:

- 30 pcs 3.5 x 30 mm
- 30 pcs 4.5 x 40 mm
- 15 pcs 6.0 x 50 mm

containing pan head screws:

- 30 pcs 3.5 x 30 mm
- 30 pcs 4.5 x 40 mm
- 15 pcs 6.0 x 50 mm

containing wallplugs:

- 60 pcs 5 x 25 mm
- 60 pcs 6 x 30 mm
- 30 pcs 8 x 40 mm

#### d) Wall Plugs only

**Art. No. 28568-D/EGK**

containing:

- 100 pcs 5 x 25 mm
- 150 pcs 6 x 30 mm
- 50 pcs 8 x 40 mm



### KISTENMACHER brand Sets of Anchors and Screws



Art. No.	type	screw	size (mm)	PU / SET
280420/EGK	PZ 1	countersunk	4.0 x 20	25
280525/EGK	PZ 2	countersunk	5.0 x 25	20
280630/EGK	PZ 2	countersunk	6.0 x 30	12
280840/EGK	PZ 3	countersunk	8.0 x 40	8
2820420/EGK	PZ 1	pan head	4.0 x 20	25
2820525/EGK	PZ 2	pan head	5.0 x 25	20
2820630/EGK	PZ 2	pan head	6.0 x 30	12
2820840/EGK	PZ 3	pan head	8.0 x 40	8
281050/EGK	HEX	pan head	10.0 x 50	4
281260/EGK	HEX	pan head	12.0 x 60	2



## Fixing Materials

### KISTENMACHER brand Wall Plugs

strong fastening solution in plasterboards, gypsum fibre boards, chipboards and other cavity walls. easy installation, no special tools required. also works effectively in cavities with insulation.

**Colour BLUE:** for one layer plasterboards  
Thickness of board: 9-18 mm, TX 25

**Colour RED:** for two layer plasterboards  
Thickness of board: 18-30 mm, TX 25

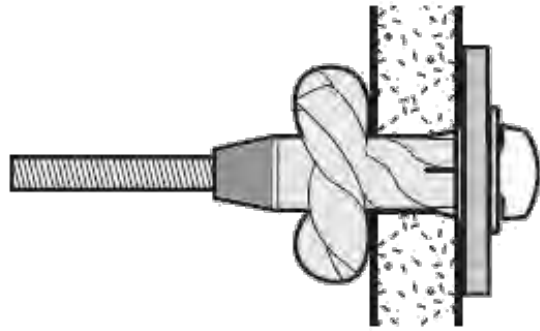

when the screw is tightened, the plug forms a strong knot on the back of board (in the cavity)



Art. No.	description	size (mm)	PU
410132/EGK	wall plug red, pan head	5 x 65	4
410133/EGK	wall plug blue, pan head	5 x 55	4
410632/EGK	wall plug red, countersunk	5 x 75	4
410633/EGK	wall plug blue, countersunk	5 x 65	4

### Gravity Toogles with threaded bars for fixing lightweight in ceiling

each set in a bag including nut + washer

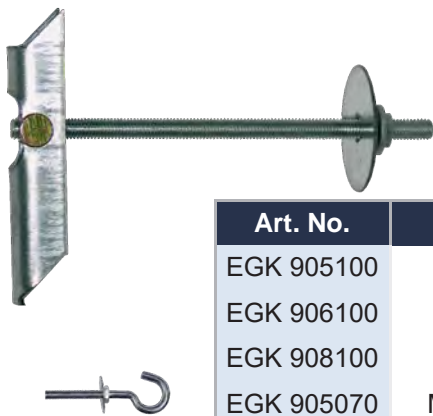

Art. No.	size
EGK 905100	M5 x 100
EGK 906100	M6 x 100
EGK 908100	M8 x 100
EGK 905070	M5 x 70 w. hook

### Spring Toogles with threaded bars for fixing lightweight in ceiling

each set in a bag including nut + washer

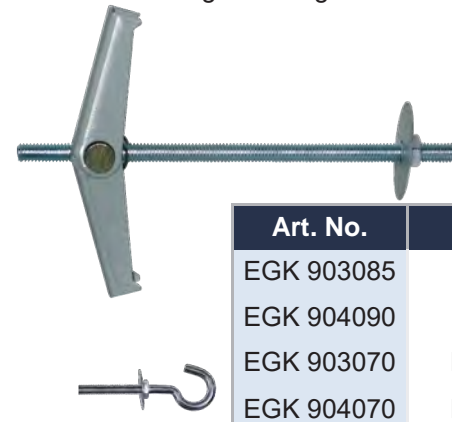

Art. No.	size
EGK 903085	M3 x 85
EGK 904090	M4 x 90
EGK 903070	M3 x 70 w. hook
EGK 904070	M4 x 70 w. hook

### Drywall Screws for plasterboard, with bugle head PH2 - phosphated

Art. No.	size (mm)	
EGK 335025	3,5 x 25	20 pcs per bag
EGK 335038	3,5 x 38	20 pcs per bag
EGK 335050	3,5 x 51	20 pcs per bag



### Anchors for hollow bricks and plasterboard panel walls

Art. No.	size (mm)	material	PU
EGK 961101	14 x 32	nylon	10 pcs per bag
EGK 961100	14 x 32	metal	10 pcs per bag



### Nylon Plug with 90° angle hook type screw

Art. No.	size (mm)	PU
282630/EGK	6 x 30 mm	4 pcs per bag
282840/EGK	8 x 40 mm	4 pcs per bag

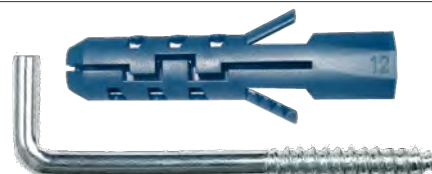

# Furniture Nails



Please add colour code to Art. No.:

No. **050** - brass plated, polished  
 No. **031** - nickel plated, polished

No. **013** - browned light  
 No. **055** - old gold spotted light  
 No. **054** - old gold spotted normal

No. **058** - brass relieved, polished  
 No. **011** - copper relieved, polished

## Flat Head Chair Nails



Art. No.	head	head	PU
1 1/4	6.0	1.60	1000
20 1/3	6.5	1.8	1000
50 1/3	7.5	2.20	1000
60 1/3	8.0	2.30	1000
90 1/3	9.0	2.40	1000
100 1/3	9.5	2.50	1000
110 1/3	10.0	2.80	1000
130 1/3	11.0	2.80	1000
160 1/3	12.5	3.00	1000
1507	14.0	4.00	1000
1505	16.0	4.20	500
1504	18.0	4.50	500
1503	20.0	5.00	500
1501	22.0	5.50	500
1500	24.0	6.00	250
1499	26.0	8.00	250
1498	28.0	7.00	250
1497	30.0	8.00	250

## Domed Head Chair Nails



Art. No.	head	head	PU
5/0	4.0	1.70	1000
3/0	4.5	1.80	1000
0	5.5	2.20	1000
20 1/2	6.5	2.50	1000
610	8.0	3.00	1000
360	9.0	3.40	1000
650	10.0	3.80	1000
660	10.5	4.00	1000
670	11.0	4.20	1000
507	12.5	4.50	1000
506	14.0	5.00	500
504	16.0	5.70	500
503	18.0	6.00	500
502	20.0	7.00	500
500	22.0	7.60	250
499	25.0	8.50	250

## Decorative Nails



Art. No.	head	head	PU
549/W	10.0	3.0	1000
548/W	12.0	3.5	1000
547/W	14.0	4.0	1000
546/W	16.0	4.4	500
545/W	19.0	5.0	500

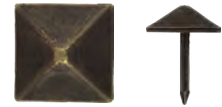

Art. No.	head	head	PU
507/F	14.0	4.0	1000
503/F	20.0	5.5	500
501/F	25.0	7.0	250



Art. No.	head dia.	head height	PU
506/0	14.0	5.0	1000
504/0	17.5	7.0	500



Art. No.	head dia.	head height	PU
1536/M	15.0	3.5	500
1533/M	21.0	4.5	500
1530/M	24.5	5.0	250



Art. No.	head	head	PU
888/L	24.5	5.5	500



Art. No.	head dia.	head height	PU
1611/M	11.0	4.0	1000

## Fixing Material

### PRYM brand Eyelets and Washers

of brass, matt



Art. No.	head dia.	head height	PU
541112**	8.0	0B	1000
541270**	9.5	2B	200
541150	10.5	3B	200
541151	11.5	4B	200
541177	12.5	5B	200
541176	13.5	6B	200
541182	14.0	7B	200
541174	15.0	8B	100
541179	17.5	9B	100
541171	19.5	10B	100
541168**	23.5	12B	100
541170**	28.5	14B	100

Art. No.	head dia.	head height	PU
541113**	8.0	0B	1000
541275**	9.5	2B	200
541149	10.5	3B	200
541153	11.5	4B	200
541155	12.5	5B	200
541175	13.5	6B	200
541159	14.0	7B	200
541161	15.0	8B	100
541163	17.5	9B	100
541165	19.5	10B	100
541169**	23.5	12B	100
541173**	28.5	14B	100

\*\* polished version

\*\* polished version

### Eyelet and Washer Puncher

consisting of upper and lower part

Art. No.	d Ø (mm)	weight (kg)
1500008	8	0,325
1500010	10	0,640
1500012	12	0,640
1500014	14	0,700
1500016	16	0,900
1500018	18	0,900
1500020	20	0,900
1500025	25	1,050
1500028	28	1,200
1500032	32	1,650
1500036	36	2,300
1500040	40	2,475

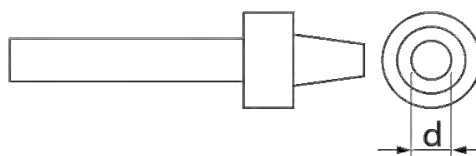



## Fixing Material



### Eyelet Pliers MAMMUT

Pressing Power of up to 1 ton!

- simple tool to change
- manual plier with gigantic force
- for DIN eyelets 14 - 20 mm
- Punching and pressing eyelets without changing tool

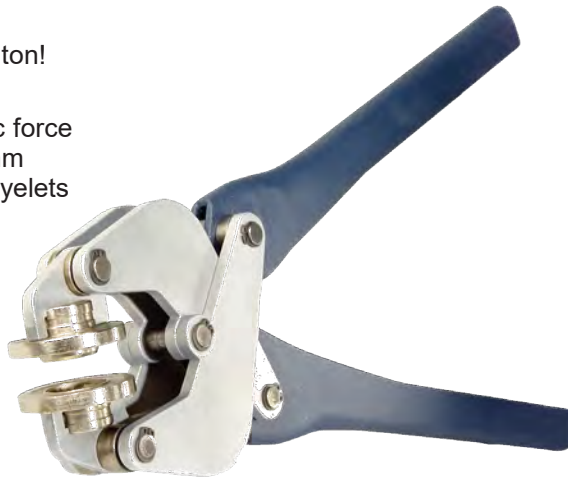

Please order required tool inserts separately

Art. No.	length	weight (g)
0920-5000	500 mm 19"	1500

Art. No.	version
0920-5214	Tool insert Ø 14 mm (pair)
0920-5216	Tool insert Ø 16 mm (pair)
0920-5218	Tool insert Ø 18 mm (pair)
0920-5220	Tool insert Ø 20 mm (pair)

### DIN Eyelets MAMMUT

bright brass finish



Art. No.	eyelets	version
0920-8140	Ø 14 mm	Bright brass
0920-8160	Ø 16 mm	Bright brass
0920-8180	Ø 18 mm	Bright brass
0920-8200	Ø 20 mm	Bright brass

### Polyethylene Strings

on spools of 50 m,  
12 spools per carton



Art. No.	Ø mm	colour
P23	1.0	red
P23W	1.0	white
P23G	1.0	green
P23Y	1.0	yellow
P232	2.0	red
P232W	2.0	white
P232G	2.0	green
P232Y	2.0	yellow

### Polypropylene Cords - Multifil

12 spools per carton



Art. No.	Ø mm	colour	length
N85R	1.0	red	50 m
N85W	1.0	white	50 m
N85G	1.0	green	50 m
N852R	2.0	red	50 m
N852W	2.0	white	50 m
N852G	2.0	green	50 m
N85100W	1.0	white	100 m
N85200W	2.0	white	100 m



## Window and Door Weatherstrips

### Premium Door-Weatherstrips

- self adhesive
- for gaps up to 18 mm
- for smooth, slightly uneven floors as well as textile floors (interior)
- Vinyl body
- Soft nylon brush

Art. No.	colour	length (m)	height (mm)	packing unit
3565331	white	1	54	10
3565332	brown	1	54	10



### Standard Door-Weatherstrips

- self adhesive
- for gaps up to 18 mm
- for smooth, slightly uneven floors (interior)
- with polypropylene brush

Art. No.	colour	length (m)	height (mm)	packing unit
3565342	white	1	46	10
3565343	brown	1	46	10
3565341	transparent	1	46	10
3565346	oak	1	46	10
3565347	hazel	1	46	10
3565348	beech	1	46	10



### Universal Door-Weatherstrips

- self adhesive
- for gaps up to 20 mm
- for smooth and slightly uneven floors (interior)
- with soft plastic sealing lip
- for use in damp locations

Art. No.	colour	length (m)	height (mm)	packing unit
3565351	white	1	44	10
3565352	brown	1	44	10



## Window and Door Weatherstrips

### Aluminium Door-Weatherstrips

- mounting with megastrap
- for gaps up to 20 mm
- for smooth and uneven floors (interior and exterior)
- with horsehair bristles

Art. No.	colour	length (m)	height (mm)	packing unit
3565305	silver matt	1	46	10
3565306	bronze matte	1	46	10

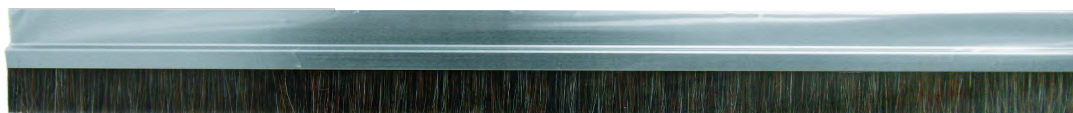

### V-profile Weatherstrips

- self-adhesive
- for gaps up to 8 mm
- especially suited for for the sealing of sliding doors

Art. No.	colour	length (m)	height (mm)	packing unit
3565541	white	10	9	6
3565542	brown	10	9	6



### Door-Weatherstrips DUO QUICK

- double sided sealing, easy and quick application. no stick or screw
- suited for indoor use



Art. No.	colour	length (m)	height (mm)	width (mm)	packing unit
3565570	anthrazit	0,95	30	100	1

## Anti-slip And Repair Tapes

### Anti-slip Tape

self-adhesive anti-slip tape and stripes to avoid slip hazards. more sure-footedness on stairs, ladders or smooth surfaces

Art. No.	colour	length (cm)	width (mm)	packing unit
3567011	black	300	19	6
3567016	black	61	19	10
3567012	black	300	38	3
3567013	transparent	300	19	6
3567014	transparent	300	38	3



### Reinforced Repair Tape - PREMIUM

- reinforced repair tape
- high temperature and weather resistance
- to tear by hand

Art. No.	colour	length (m)	width (mm)	packing unit
3563040	silver	10	50	4
3563091	black	10	50	4
3563093	white	10	50	4
3563095	green	10	50	4
3563041	silver	25	48	3
3563098	black	25	48	3
3563042	silver	50	48	3
3563101	black	50	48	3
3563100	white	50	48	3



### Reinforced Repair Tape - STANDARD

- reinforced repair tape
- high temperature and weather resistance
- to tear by hand

Art. No.	colour	length (m)	width (mm)	packing unit
3563090	silver	50	48	6
3563105	black	50	48	6
3563106	white	50	48	6
3563103	silver	25	48	6
3563104	silver	25	30	9



## Repair Tapes

### Transparent Repair Tape

especially suitable for repair of glass and transparent plastics



Art. No.	colour	length (m)	width (mm)	packing unit
3563092	transparent	10	50	4

### Aluminium Tape - extra strong

pure aluminium tape for repairing and sealing the interior and exterior. the tape is particularly suitable for covering weld seams and over-bonding of joints and gaps.

- good UV and weather resistance
- very high temperature resistance



Art. No.	colour	length (m)	width (mm)	packing unit
3563293	silver	5	50	4
3563295	silver	10	50	4

### Aluminium Foil Tape

aluminium-vaporised foil tape for sealing and isolating roof work or laying laminate. self-adhesive.

Art. No.	colour	length (m)	width (mm)	packing unit
3563294	silver	50	50	4



### Self-amalgamating Repair Tape

ideal for household repairs, hobbies, plumbing and electrical industries.

- self-amalgamating polyisobutyl
- UV and weather resistant
- insulating against current (up to a maximum of 35.000 V)
- water resistant



Art. No.	colour	length (m)	width (mm)	packing unit
3563085	black	10	19	6

## Repair Tapes

### Insulation Tape

for repairing and insulating electric cables or lustre terminals

- up to 6000 Volts
- high temperature resistant
- self-extinguishing
- tested according to VDE 0340

Art. No.	colour	length (m)	width (mm)	packing unit
3563282	white	10	15	6
3563281	black	10	15	6



### Double-sided mounting Mirror Tape

double-sided mounting tape for fastening mirrors, mirror tiles etc. permanently, humidity resistant, for interior use

Art. No.	colour	length (m)	width (mm)	packing unit
3563055	white	1,5	19	6
3563056	white	5	19	6
3583057	white	66	19	15



## Hooks & Carpet Tapes

### Stainless Steel Hooks with Megastrap

high quality stainless steel hooks for fixing objects in bathroom and kitchen.

- strong hold up to 0,75 kg
- suitable for application on smooth surfaces
- attachment with fix-o-moll Megastrap
- clean removal
- waterproof

Art. No.	shape	dia (mm)	pieces	packing unit
3562926	round	35	2	6
3562927	oval	21 x 34	2	6



### Plastic Hooks

these plastic hooks, equipped with self-adhesive mounting tape, are ideal for fixing objects in the household

- suitable for application on smooth surfaces such as tiles, in cabinets etc.

Art. No.	colour	pieces	width (mm)	height (mm)	packing unit
3566707	silver	1	32	54	5
3566706	white	1	32	54	5
3566705	silver	2	26	43	5
3566704	white	2	26	43	5
3566703	silver	3	15	24	5
3566702	white	3	15	24	5
3562924	silver	2	∅	35	6
3562925	white	2	∅	35	6



### Carpet Tapes - STANDARD

- film tape
- normal load
- permanently double-sided adhesive
- versatile applicable
- -10 up to +60°C

Art. No.	length (m)	width (mm)	packing unit
3563195	5	50	4
3563196	10	50	4
3563197	25	50	3
3563198	5	38	5
3563199	10	38	5
3563200	25	38	5



## Carpet Tapes & Crack Cover

### Carpet Tapes - PROFI

- extra strong
- fabric-reinforced
- heavy load
- permanently double-sided adhesive



Art. No.	length (m)	width (mm)	packing unit
3563192	5	50	4
3563193	10	50	4
3563194	25	50	3

### Carpet Tapes - SUPER

- fabric-reinforced
- heavy load
- permanently double-sided adhesive
- for rough surfaces
- -10 up to +60°C



Art. No.	length (m)	width (mm)	packing unit
3563191	5	50	4
3563189	10	50	4
3563190	25	50	3

### Crack cover

- covering of cracks and plug holes
- paint and wallpaper can be applied directly after use
- invisible under wallpaper



Art. No.	colour	length (m)	width (mm)	packing unit
3563221	white	10	50	4

### Crack cover fibreglass

- for plasterboard and dry wall joints
- for wall and ceiling repairs
- robust and sturdy



Art. No.	colour	length (m)	width (mm)	packing unit
3563222	white	20	50	4



## Masking Tapes

### Masking tape for straight clean edges

for straight clean edges on smooth surfaces in indoor areas.  
reliable adhesion, no paint underflow, clean removal.

Art. No.		colour	length (m)	width (mm)	set/pcs	packing unit
3563011		chamois	50	19		7
3563012		chamois	50	25		6
3563013		chamois	50	30		5
3563014		chamois	50	38		4
3563015		chamois	50	50		3
3563111	ECO	chamois	50	19		12
3563113	ECO	chamois	50	30		8
3563114	ECO	chamois	50	38		6
3563115	ECO	chamois	50	50		5
3563122	ECO	chamois	2 x 50	25	2	24
3563123	ECO	chamois	2 x 50	38	2	12
3563124	ECO	chamois	2 x 50	50	2	12
3563116	ECO	chamois	3 x 50	30	3	1
3563118	ECO	chamois	3 x 50	19	3	1
				30		
				50		



### Coverfix 2in1

masking tape with attached foil - for razor-sharp masking and protection of large areas in a single step.

Art. No.		colour	length (m)	width (cm)	packing unit
3563177	Refill XL	transparent	17	270	2
3563183	Refill L	transparent	33	140	2
3563185	Refill M	transparent	33	55	2



### Protection foil Standard

for covering and protecting large areas during renovation. the electrostatically charged film clings to the surface and thus offers optimal protection from paint splashes.

Art. No.		colour	length (m)	width (m)	packing unit
3563016	20 m <sup>2</sup> , 8µm	transparent	4	5	20



## Parcel Tapes

### Parcel Tape PROFI

PVC no noise

Art. No.	colour	length (m)	width (mm)	packing unit
3563335	brown	66	50	6
3563336	transparent	66	50	6



### Parcel Tape UNIVERSAL

PP no noise

Art. No.	colour	length (m)	width (mm)	packing unit
3563333	brown	66	50	6
3563334	transparent	66	50	6
3563337	brown	66	38	8
3563338	transparent	66	38	8



### Parcel Tape BASIC PP

Art. No.	colour	set pcs	length (m)	width (mm)	packing unit
3563330	brown		66	48	6
3563331	transparent		66	48	6
3563328	brown	3	3x66	48	12
3563329	transparent	3	3x66	48	12



### Dispenser for parcel tape

standard dispenser for parcel tape for secure and clean sealing of packages. usable for rolls of 66 m. roll breadth up to 50 mm.

Art. No.	length of roll	max. roll breadth
3563341	66 m	50 mm



## Door Wedges

### Door Wedges

doors are securely fixed with a door wedge and the slamming of doors is prevented.

Art. No.	colour	pieces	length (mm)	width (mm)	packing unit
3566691	transparent	1	97	35	5
3566690	transparent	1	97	40	6
3566689	black	1	97	40	6



### Hook and Loop Tape

- self-adhesive
- can be cut to size
- hold light objects

Art. No.	colour	length (cm)	width (mm)	packing unit
3563405	white	60	20	6
3563406	black	60	20	6
3563407	light-grey	60	20	6
3563002	white	150	20	4
3563003	black	150	20	4
3563413	light-grey	150	20	4
3563411	white	300	20	4
3563412	black	300	20	4



### Hook and Loop Pads and Dots

- self-adhesive
- pre-assembled, glued directly
- hold light objects

Art. No.	colour	sets	length (mm)	width (mm)	packing unit
3563422	white	12	25	25	15
3563423	black	12	25	25	15
3563421	black-grey	4	48	25	15
3563424	white	2	Ø	35	15
3563425	black	2	Ø	35	15
3563426	red	8	Ø	20	15
3563427	white	8	Ø	20	15
3563428	black	8	Ø	20	15



## Plastic Gliders and Door Stops

### Carpet Gliders

carpet gliders allow the movement of furniture or objects on textile surfaces. laminates, tiles etc. and carpets are safely protected. self-adhesive carpet gliders made of durable plastic with very good gliding abilities and sound absorbing felt insert.



Art. No.	colour	pieces	dia (mm)	packing unit
3566467	white	8	18	15
3566468	white	8	22	15
3566469	white	8	26	15



### Cork Pads

cork pads are fastened under movable objects and protect furniture surfaces against scratches and damages. self-adhesive.

Art. No.	pieces	length (mm)	width (mm)	height (mm)	packing unit
3566392	9	Ø	28	2,1	5
3566393	1	200	100	2,1	5

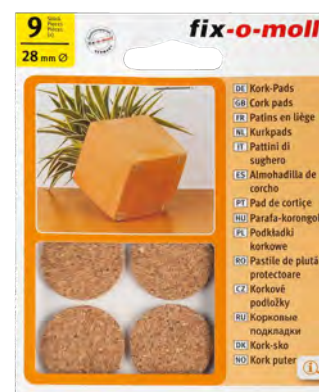

### Protection Buffers

protection against damages, self-adhesive

Art. No.	colour	pieces	length (mm)	width (mm)	packing unit
3566673	white	9	Ø	21	15
3566674	white	9	Ø	28	15
3566675	white	9	28	28	15
3566676	white	1	200	100	15



### Door Stops

protect walls and furniture against damage from slamming doors. with plug and screw.



Art. No.	colour	pieces	dia (mm)	packing unit
3566680	white	2	22	5
3566681	beige	2	22	5
3566682	brown	2	22	5
3566683	transparent	2	22	5
3566684	white	1	30	5
3566685	light grey	1	30	5
3566687	white	1	40	5
3566686	light grey	1	40	5
3566688	white	2	21	6

## Felt Gliders

### Felt Gliders and Felt Pads, self-adhesive

self-adhesive felt gliders allow the effortless movement of furniture or objects on smooth surfaces without either noise or damage to the floor. laminates, tiles etc. are safely protected. made of abrasion-resistant needle felt, with strong adhesive for simple and secure fastening.

Art. No.	colour	length (mm)	width (mm)	height (mm)	set/pcs	packing unit
3566300	white	∅	17	3	20	15
3566340	brown	∅	17	3	20	15
3566320	white	22	22	3	16	15
3566360	brown	22	22	3	16	15
3566327	white	16	44	3	8	15
3566367	brown	16	44	3	8	15

Many other sizes available on request



### Felt Gliders with Pin

felt gliders with pin allow the effortless movement of chairs or tables on smooth surfaces without either noise or damage to the floor. laminates, tiles etc. are safely protected. made of abrasion-resistant needle felt, simple and secure fastening with pin, suitable for wooden furniture legs. wooden furniture legs must be pre-drilled.



Art. No.	colour	pieces	dia (mm)	packing unit
3566201	white	8	20	4
3566210	brown	8	20	4
3566202	white	16	20	4
3566211	brown	16	20	4
3566204	white	8	24	4
3566213	brown	8	24	4
3566207	white	4	28	4
3566216	brown	4	28	4

Many other sizes available on request

### Felt Gliders with Screws

parquet gliders with screw allow the gentle and safe movement of chairs or tables without either noise or damage to the floor. exclusive tiles, fine parquet and top-quality laminates are safely protected against nasty scratches. simple and secure fastening with screw, stable metal socket and very thick and smooth gliding felt layer ensure long durability and top wear and abrasion resistance of the parquet gliders. suitable for wooden furniture legs. wooden furniture legs must be pre-drilled.



Art. No.	colour	pieces	dia (mm)	packing unit
3566230	nature	4	20	4
3566231	nature	16	20	4
3566147	nature	4	24	4
3566148	nature	16	24	4
3566237	nature	4	28	4
3566169	nature	16	28	4



## Glass Sliding Door Fittings

- elegant design
- gold or silver colour
- easy to fix



### Aluminium Glass Sliding Door Fittings

#### Made in Germany

Precise and elegant aluminium profiles in combination with runners ensure smooth and quiet functionality. The fitting features great variety of application by simply altering the basic parts.

Aluminium profiles are available in brass or silver anodized finish, supplied in sets including all necessary accessories.

## Glass Sliding Door Fittings



silver

Art. No.: 57700.68.29



gold

Art. No.: 57700.71.29

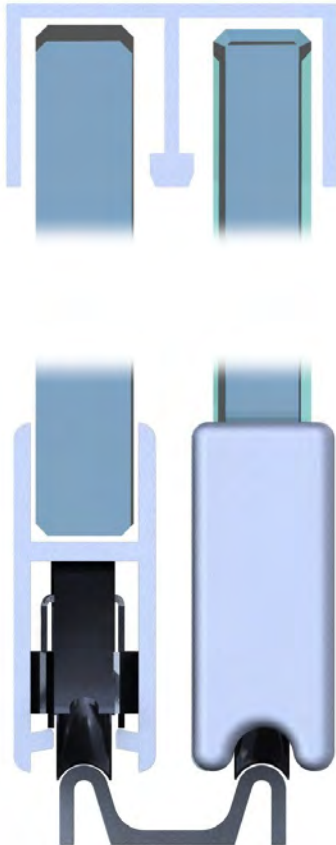

easy fix

### Technical details

- suitable for glass panes of 6 or 8 mm thickness
- 4 runners holding glass panes up to 140 kgs weight
- zink-plated steel runners with noise reducing ball bearings
- self-adhesive twin track bottom rail
- easy and quick assembling with special mounting tool
- all profile surfaces equipped with transparent protection foil

### Content per case (brass or silver coloured)

- 10 x 5 mtr. aluminium twin track bottom rail
- 10 x 5 mtr. aluminium shoe rail
- 10 x 5 mtr. aluminium top rail
- 100 pieces plastic end cap in matching colour
- 150 pieces steel runner, zink plated
- 5 pieces runner mounting tool

## Shelving Systems



### Wall Uprights - Single Slotted

suitable as end elements for wall mounted shelf units in combination with double slotted uprights - pair packing

**RAL 9003 white**  
**RAL 9006 silver**  
**RAL 8014 brown**

Art. No. RAL 9003 white	Art. No. RAL 9006 silver	Art. No. RAL 8014 brown	length (cm)
10000-00000	10000-00005	10000-00003	50
10000-00010	10000-00014	10000-00012	80
10000-00017	10000-00023	10000-00020	100
10000-00028	10000-00034	10000-00031	150
10000-00039	10000-00044	10000-00041	200
10000-00049	10000-00054	10000-00051	250



### Wall Uprights - Double Slotted

permit shelves, baskets, ets. to be mounted immediately alongside each other - pair packing

**RAL 9003 white**  
**RAL 9006 silver**  
**RAL 8014 brown**

Art. No. RAL 9003 white	Art. No. RAL 9006 silver	Art. No. RAL 8014 brown	length (cm)
10001-00001	10001-00005	10001-00003	50
10001-00010	10001-00014	10001-00012	100
10001-00019	10001-00023	10001-00021	150
10001-00028	10001-00032	10001-00030	200
10001-00037	10001-00041	10001-00039	250



### Clip-On Holders

support for wooden and glass shelves, 12 pcs/box

**Art. No. 11604-00001**  
**Art. No. 11612-00001**

single sided  
 double sided

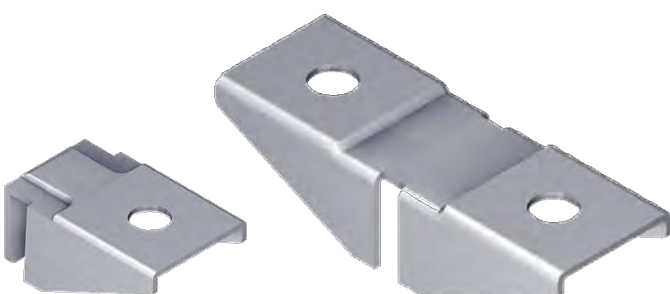

### Suction Pads

can be installed on clip-on and insert holders to support glass or wooden shelves, 20 pcs/box

**Art. No. 11605-00001**





## Shelving Systems

### Angle Brackets

suspension hooks, specific left-hand and right-hand, designs permit use as attractive brackets for the ends of shelves - pair packing

**RAL 9003 white**  
**RAL 9006 silver**  
**RAL 8014 brown**

Art. No. RAL 9003 white	Art. No. RAL 9006 silver	Art. No. RAL 8014 brown	length (cm)
10300-00019	10300-00023	10300-00021	18
10300-00026	10300-00030	10300-00028	23
10300-00033	10300-00037	10300-00035	28
10300-00040	10300-00044	10300-00042	33
10300-00047	10300-00051	10300-00049	38
10300-00000	10300-0004	10300-00002	48

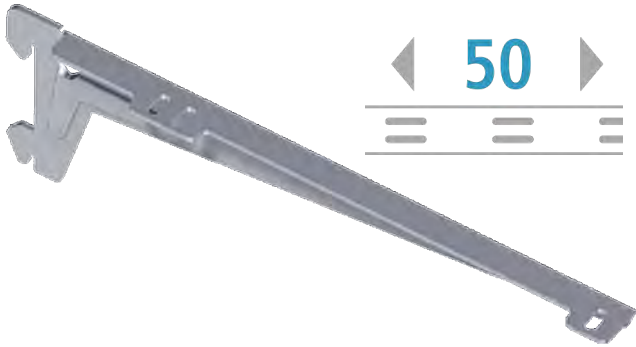

### Safety Brackets, Two Lugs, Shelf Support

#### Locking System

can be used with all types of wall uprights

**RAL 9003 white**  
**RAL 9006 silver**  
**RAL 8014 brown**

Art. No. RAL 9003 white	Art. No. RAL 9006 silver	Art. No. RAL 8014 brown	length (cm)
10105-00001	10105-00003	10105-00004	10
10105-00101	10105-00103	10105-00104	15
10105-00201	10105-00203	10105-00204	20
10105-00301	10105-00303	10105-00304	25
10105-00401	10105-00403	10105-00404	30
10105-00501	10105-00503	10105-00504	35
10105-00601	10105-00603	10105-00604	40
10105-00801	10105-00803	10105-00804	50

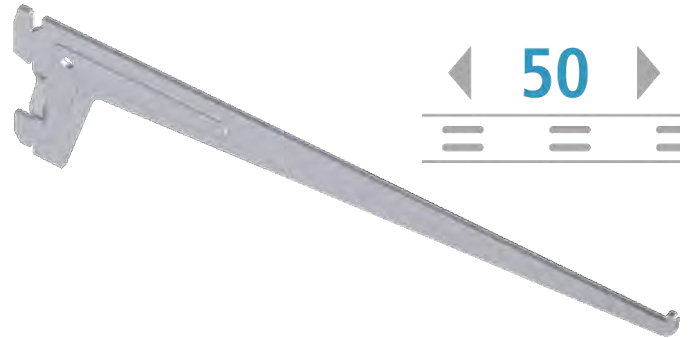

### U-Brackets

can be used with double slotted wall upright

**RAL 9003 white**  
**RAL 9006 silver**  
**RAL 8014 brown**

Art. No. RAL 9003 white	Art. No. RAL 9006 white	Art. No. RAL 8014 brown	length (cm)
10201-00000	10201-00004	10201-00002	12
10201-00002	10201-00006	10201-00004	17
10201-00008	10201-00012	10201-00000	22
10201-00015	10201-00019	10201-00000	27
10201-00021	10201-00025	10201-00000	37
10201-00027	10201-00031	10201-00000	47
10201-00032	10201-00036	10201-00000	52
10201-00037	10201-00041	10201-00000	57

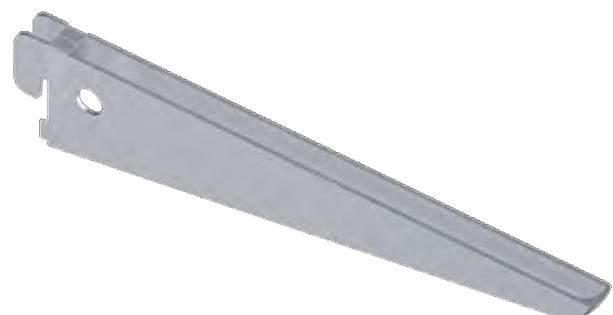

## Shelving Systems

### Steel Shelves

can be used with brackets - Ref. 10105

RAL 9003 white  
RAL 9006 silver

Art. No. RAL 9003 white	Art. No. RAL 9006 silver	size (cm)
10300-00019	10300-00023	20 x 80
10300-00026	10300-00030	25 x 80
10300-00033	10300-00037	30 x 80
10300-00040	10300-00044	35 x 80



### Perforated Steel Panels

suitable for use with with all wall-mounted tracks

RAL 9003 white  
RAL 9006 silver

Art. No. RAL 9003 white	Art. No. RAL 9006 silver	size (cm)
11400-00004	11400-00007	20 x 80

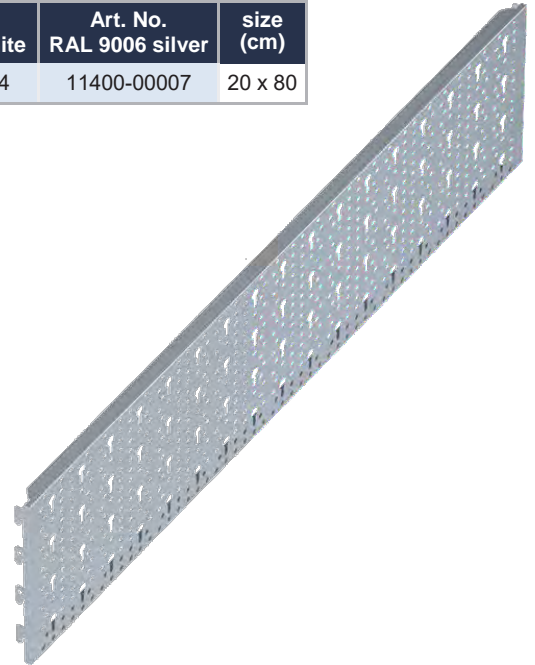

### Shelf Set Storage

- flexible shelf solution with 2 TWIN wire shelves
- TWIN wire shelves allow an optimal view of the content on your shelf - especially at higher levels
- TWIN wire shelves provide almost no space for dust and allow an optimal air circulation
- quick and easy to install
- compact solution for areas such as office, pantry, garage, workshop, laundry etc.
- colour: white aluminium

Art. No.	dimensions (w x h x d)	max. load	PU
11356-01030	828 x 496 x 332 mm	20 kg / 44 lbs	7



set contents	qty
wall upright double, 500 mm, white aluminium	2
twin wire shelf bracket, 320 mm, white aluminium	4
twin wire shelf, 800 x 300 mm, white aluminium	2
screws and dowels in wrapping	6

## Shelving Systems



### Shelf Set Office 3

- flexible shelf solution with 2 steel shelves
- the washable surface of steel shelves makes them ideally suited for wide ranging applications
- quick and easy to install
- compact solution for areas such as office, pantry, garage, workshop, laundry etc.
- colour: white

Art. No.	dimensions (w x h x d)	max. load
11356-00000	828 x 496 x 320 mm	30 kg / 66 lbs



set contents	qty
wall upright double, 500 mm, white	2
bracket, 300 mm, white	4
steel shelf, 800 x 300 mm, white	2
screws and dowels in wrapping	6

### Shelf Set Walk-in Closet

- flexible wardrobe solution with 3 TWIN wire shelves
- quick and easy to install
- used in areas such as corridor, walk-in closet, wardrobe, laundry room etc.
- colour: white

Art. No.	dimensions (w x h x d)	max. load
11356-00010	996 x 911 x 331 mm	shelf: 20 kg / 44 lbs tube: 15 kg / 33 lbs



set contents	qty
wall upright double, 1000 mm, white	2
twin wire shelf bracket, 320 mm, white	6
twin wire shelf, 800 x 300 mm, white	3
twin tube, 900 mm, chrome	1
twin tube holder + endcap-set, white	1
screws and dowels in wrapping	12



## Door Safety

### eff-eff brand Mortise Latches

small, easily mounted version - can be used as an additional locking mechanism in combination with fail unlocked electric strike

Art. No. **802/00** size: 55 x 20.0 mm - depth 30.0 mm

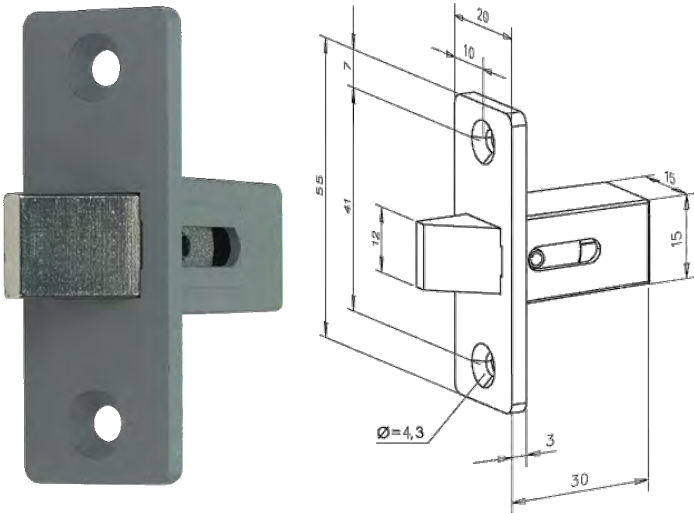

### eff-eff brand Rim Latches

matching part for surface-mounted door strikes

- suitable for special structures
- is used as additional locking device with fail-unlocked door strike

Art. No. **804/00** size: 20 x 34.0 mm - depth 44.0 mm

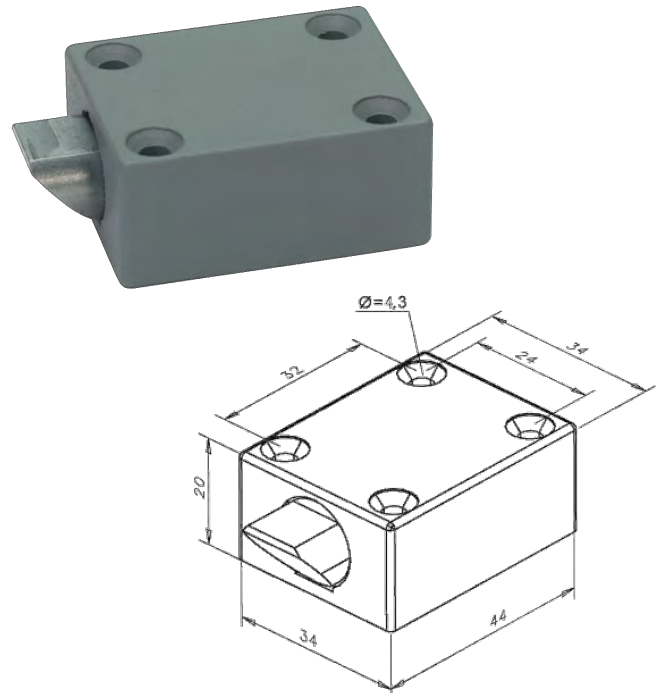

### eff-eff brand Electric Door Openers

- suitable for all common striking plates, housing made of die-cast zinc

- suitable for DIN right and left due to 180° fitting, 6-12V

Art. No. **14/D11** size: 90 x 20.0 mm - depth 28.2 mm

Art. No. **17/D11** size: 75 x 20.5 mm - depth 28.0 mm

**17/D11**

**14/D11**



### eff-eff brand Push-Buttons

surface mounted push-button with key symbol - white colour

Art. No. **1010/00** size: 60 x 61.0 mm - depth 22 mm



## Door Safety



### eff-eff brand ANYKEY® Security Door Fittings

the access code version of ANYKEY® is the ideal solution for applications requiring increased security

- designed for three to eight digit codes thus enabling a maximum of 100 million potential codes - stand alone device, suitable for door leaf thickness from 38 - 43 mm
- scope of delivery: 1 interior door fitting, 1 exterior door fitting, 1 mounting accessory kit, 4 batteries (type AA)

Art. No. **49610804011-B86**

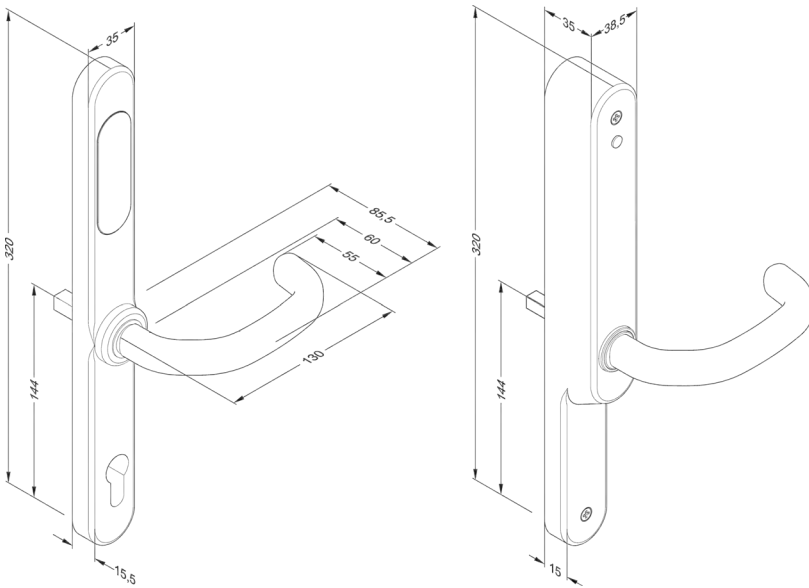

### eff-eff brand Flat Striking Plates

DIN left and right usable, thickness 3 mm

- Art. No. **02135-01** size 250 x 25 mm with dead bolt cutout
- Art. No. **09635-01** size 130 x 24 mm with latch bolt aperture

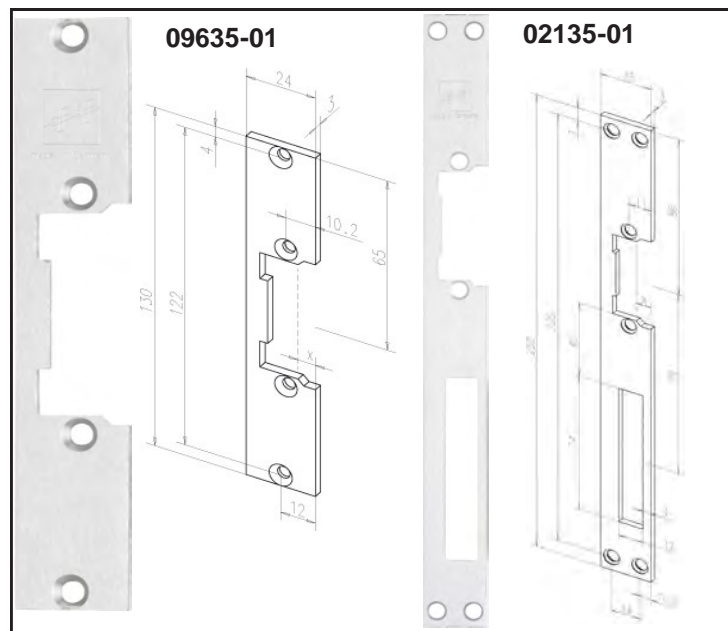

# Castor Wheels



## Castor Wheels Series ALPHA

housing made of pressed steel, zinc-chromatised,  
wheel centre made of pressed steel  
Tread: solid rubber, black, roller bearing



BETTER MOBILITY. BETTER LIFE.

Plate Fitting

Bolt Hole



Swivel Type

Fixed Type

Brake Type



double ball bearing swivel head,  
dustguard, wheel axle with nut

fork made of pressed steel,  
zinc-chromatised, wheel axle  
with nut

with total lock, tail end of castor,  
double ball bearing swivel head,  
dustguard, wheel axle with nut

Art. No. swivel type	Art. No. fixed type	Art. No. brake type	size (mm)	load capacity (kg)
3470 DVR 100 P62	3478 DVR 100 P62	3477 DVR 100 P62	100	75
3470 DVR 125 P62	3478 DVR 125 P62	3477 DVR 125 P62	125	100
3470 DVR 160 P63	3478 DVR 160 P63	3477 DVR 160 P63	160	135
3470 DVR 200 P63	3478 DVR 200 P63	3477 DVR 200 P63	200	205



BETTER MOBILITY. BETTER LIFE.

## Castor Wheels



### Castor Wheels Series ALPHA

housing made of pressed steel, zinc-chromatised,  
wheel centre made of polypropylene  
Tread: solid rubber, black, roller bearing



BETTER MOBILITY. BETTER LIFE.

#### Swivel Type



double ball bearing swivel head,  
dustguard, wheel axle with nut

#### Fixed Type



fork made of pressed steel,  
zinc-chromatised, wheel axle  
with nut

#### Brake Type



with total lock, tail end of castor,  
double ball bearing swivel head,  
dustguard, wheel axle with nut

Art. No. swivel type	Art. No. fixed type	Art. No. brake type	size (mm)	load capacity (kg)
3470 PVR 080 P62	3478 PVR 080 P62	3477 PVR 080 P62	80	70
3470 PVR 100 P62	3478 PVR 100 P62	3477 PVR 100 P62	100	75
3470 PVR 125 P62	3478 PVR 125 P62	3477 PVR 125 P62	125	100
3470 PVR 160 P63	3478 PVR 160 P63	3477 PVR 160 P63	160	135
3470 PVR 200 P63	3478 PVR 200 P63	3477 PVR 200 P63	200	205

### Stainless Steel Castor Wheels Series ALPHA

housing made of stainless steel, wheel centre made of polyamide, white  
Tread: polyurethane, purple, roller bearing, stainless

#### Swivel Type



double ball bearing swivel head,  
dustguard, wheel axle with nut

#### Fixed Type



fork made of stainless steel,  
wheel axle with nut

#### Brake Type



with total lock, tail end of castor,  
double ball bearing swivel head,  
dustguard, wheel axle with nut

Art. No. swivel type	Art. No. fixed type	Art. No. brake type	size (mm)	load capacity (kg)
8470 UAD 080 P62	8478 UAD 080 P62	8477 UAD 080 P62	80	100
8470 UAD 100 P62	8478 UAD 100 P62	8477 UAD 100 P62	100	150
8470 UAD 125 P62	8478 UAD 125 P62	8477 UAD 125 P62	125	200
8470 UAD 160 P63	8478 UAD 160 P63	8477 UAD 160 P63	160	350
8470 UAD 200 P63	8478 UAD 200 P63	8477 UAD 200 P63	200	400



# Castor Wheels



## Castor Wheels Series ALPHA

housing made of pressed steel, zinc-chromatised,  
wheel centre made of polyamide, black / white, roller bearing  
all types optionally available in white colour!  
size 200 mm only available in white colour!



BETTER MOBILITY. BETTER LIFE.

\* to order white version please add „white“ to the Art. No.

Plate Fitting

Bolt Hole



Swivel Type



double ball bearing swivel head,  
dustguard, wheel axle with nut

Fixed Type



fork made of pressed steel,  
zinc-chromatised, wheel axle  
with nut

Brake Type



with total lock, tail end of castor,  
double ball bearing swivel head,  
dustguard, wheel axle with nut

Art. No. swivel type	Art. No. fixed type	Art. No. brake type	size (mm)	load capacity (kg)
3470 UOR 100 P62	3478 UOR 100 P62	3477 UOR 100 P62	100	200
3470 UOR 125 P63	3478 UOR 125 P63	3477 UOR 125 P63	125	250
3470 UOR 160 P63	3478 UOR 160 P63	3477 UOR 160 P63	160	350
3470 UOR 200 P63	3478 UOR 200 P63	3477 UOR 200 P63	200	350



BETTER MOBILITY. BETTER LIFE.

## Castor Wheels



### Castor Wheels Series ALPHA

housing made of pressed steel, zinc-chromatised,  
wheel centre made of polypropylene, dark grey,  
roller bearing



BETTER MOBILITY. BETTER LIFE.

#### Swivel Type



double ball bearing swivel head,  
dustguard, wheel axle with nut

#### Fixed Type



fork made of pressed steel,  
zinc-chromatised, wheel axle  
with nut

#### Brake Type



with total lock, tail end of castor,  
double ball bearing swivel head,  
dustguard, wheel axle with nut

Art. No. swivel type	Art. No. fixed type	Art. No. brake type	size (mm)	load capacity (kg)
3470 POR 080 P62	3478 POR 080 P62	3477 POR 080 P62	80	125
3470 POR 100 P62	3478 POR 100 P62	3477 POR 100 P62	100	125
3470 POR 125 P62	3478 POR 125 P62	3477 POR 125 P62	125	125

### Castor Wheels Series AGILA-TWIN

housing made of pressed steel, zinc-chromatised,  
wheel made of polyamide, plain bearing

#### Swivel Type



double ball bearing swivel head,  
wheel axle with nut

#### Brake Type



with wheel brake, double ball bearing  
swivel head, wheel axle with nut

Art. No. swivel type	plate fitting / bolt hole	Art. No. brake type	size (mm)	load capacity (kg)
2970 UOO 050 P40		2975 UOO 050 P40	50	70
2970 UOO 050 P30	bolt hole 11 mm	2975 UOO 050 P30	50	70



# Castor Wheels



## Castor Wheels Series ALPHA

housing made of pressed steel, zinc-chromatised,  
wheel centre made of polyamide, white, plain bearing



BETTER MOBILITY. BETTER LIFE.

Plate Fitting

Bolt Hole



Swivel Type

Fixed Type

Brake Type



double ball bearing swivel head,  
dustguard, wheel axle with nut

fork made of pressed steel,  
zinc-chromatised, wheel axle  
with nut

with total lock, tail end of castor,  
double ball bearing swivel head,  
dustguard, wheel axle with nut

Art. No. swivel type	Art. No. fixed type	Art. No. brake type	size (mm)	load capacity (kg)
3470 UOO 080 P62	3478 UOO 080 P62	3477 UOO 080 P62	80	200
3470 UOO 100 P62	3478 UOO 100 P62	3477 UOO 100 P62	100	200
3470 UOO 125 P62	3478 UOO 125 P62	3477 UOO 125 P62	125	275
3470 UOO 160 P63	3478 UOO 160 P63	3477 UOO 160 P63	160	350
3470 UOO 200 P63	3478 UOO 200 P63	3477 UOO 200 P63	200	350



BETTER MOBILITY. BETTER LIFE.

# Castor Wheels



## Castor Wheels Series AGILA

housing made of pressed steel, zinc-chromatised,  
wheel centre made of Polypropylene  
Tread: TENTEprene (thermoplastic rubber),  
grey non-marking, plain bearing



BETTER MOBILITY. BETTER LIFE.

Plate Fitting

Bolt Hole



Swivel Type



double ball bearing swivel head,  
wheel axle with nut

Fixed Type



fixed castor, fork made of  
pressed steel, wheel axle with  
nut, plate fitting

Brake Type



with total lock, tail end of castor,  
double ball bearing swivel head,  
wheel axle with nut

Art. No. swivel type	Art. No. fixed type	Art. No. brake type	size (mm)	load capacity (kg)	plate fitting / bolt hole
2470 PJI 050 P40	2478 PJI 050 P41	2475 PJI 050 P40	50	40	p-fit
2470 PJO 075 P40	2478 PJO 075 P60	2477 PJO 075 P40	75	55	p-fit
2470 PJO 100 P50	2478 PJO 100 P50	2477 PJO 100 P50	100	80	p-fit
2470 PJO 125 P50	2478 PJO 125 P50	2477 PJO 125 P50	125	100	p-fit
2470 PJO 150 P50	2478 PJO 150 P50	2477 PJO 150 P50	150	100	p-fit
2470 PJI 050 P30		2475 PJI 050 P30	50	40	hole 11
2470 PJO 075 P30		2477 PJO 075 P30	75	55	hole 11
2470 PJO 100 P30		2477 PJO 100 P30	100	80	hole 11
2470 PJO 125 P30		2477 PJO 125 P30	125	100	hole 11
2470 PJO 150 P30		2477 PJO 150 P30	150	100	hole 11



BETTER MOBILITY. BETTER LIFE.

# Castor Wheels



## Castor Wheels Series AGILA

housing made of pressed steel, zinc-chromatised,  
 wheel centre made of pressed steel  
 Tread: solid rubber, with threadguards,  
 grey non-marking, plain bearing



BETTER MOBILITY. BETTER LIFE.

Plate Fitting

Bolt Hole



Swivel Type



double ball bearing swivel head,  
 wheel axle with nut

Fixed Type



fixed castor, fork made of  
 pressed steel, wheel axle with  
 nut, plate fitting

Brake Type



with total lock, tail end of castor,  
 double ball bearing swivel head,  
 wheel axle with nut

Art. No. swivel type	Art. No. fixed type	Art. No. brake type	size (mm)	load capacity (kg)	plate fitting / bolt hole
2470 DIK 050 P40	2478 DIK 050 P40	2475 DIK 050 P40	50	40	p-fit
2470 DIK 075 P40	2478 DIK 075 P60	2477 DIK 075 P40	75	55	p-fit
2470 DIK 100 P50	2478 DIK 100 P50	2477 DIK 100 P50	100	80	p-fit
2470 DIK 125 P50	2478 DIK 125 P50	2477 DIK 125 P50	125	100	p-fit
2470 DIK 150 P50	2478 DIK 150 P50	2477 DIK 150 P50	150	100	p-fit
2470 DIK 050 P30		2475 DIK 050 P30	50	40	hole 11
2470 DIK 075 P30		2477 DIK 075 P30	75	55	hole 11
2470 DIK 100 P30		2477 DIK 100 P30	100	80	hole 11
2470 DIK 125 P30		2477 DIK 125 P30	125	100	hole 11
2470 DIK 150 P30		2477 DIK 150 P30	150	100	hole 11



BETTER MOBILITY. BETTER LIFE.

## Castor Wheels



### Castor Wheels Series LEVINA

housing and wheels made from high grade synthetic materials, with integrated threadguards, all metal parts are yellow passivated, wheel centre made of polypropylene  
Tread: TENTEprene (thermoplastic rubber), grey non-marking



BETTER MOBILITY. BETTER LIFE.

**Swivel Type**



precision ball bearing, with threadguards

**Brake Type**



with total lock, tail end of castor, precision ball bearing, with threadguards

Plate Fitting



Bolt Hole



Art. No. swivel type	Art. No. brake type	size (mm)	load capacity (kg)
5320 PJP 075 P40	5320 PJP 075 P40	75	100
5370 PJP 100 P50	5377 PJP 100 P50	100	100
5370 PJP 125 P50	5377 PJP 125 P50	125	100
5370 PJP 150 P50	5377 PJP 150 P50	150	100

### Castor Wheels for Shopping Trolleys

swivel castor, housing made of pressed steel, zinc-chromatised, double ball bearing swivel head, wheel axle with nut, wheel centre made of polypropylene.  
Tread: TENTEprene (thermoplastic rubber), grey non-marking, precision ball bearing, with threadguards, bolt hole



Art. No. swivel Type	size (mm)	load capacity (kg)	plate fitting / bolt hole
2370 PJP 100 P30	100	100	bolt hole 11
2370 PJP 125 P30	125	100	bolt hole 13



BETTER MOBILITY. BETTER LIFE.



## Castor Wheels



BETTER MOBILITY. BETTER LIFE.

### Castor Wheels grey or blue\* Series ALPHA

housing made of pressed steel, zinc-chromatised,  
wheel centre made of polypropylene

Tread: elastic-tyre, grey / blue, non-marking, roller bearing

\* to order blue version please add „blue“ to the Art. No.

#### Swivel Type



double ball bearing swivel head,  
dustguard, wheel axle with nut

#### Fixed Type



fork made of pressed steel,  
zinc-chromatised, wheel axle  
with nut

#### Brake Type



with total lock, tail end of castor,  
double ball bearing swivel head,  
dustguard, wheel axle with nut

Art. No. swivel type	Art. No. fixed type	Art. No. brake type	size (mm)	load capacity (kg)
3470 UFR 100 P62*	3478 UFR 100 P62*	3477 UFR 100 P62*	100	160
3470 UFR 125 P62*	3478 UFR 125 P62*	3477 UFR 125 P62*	125	250
3470 UFR 160 P63	3478 UFR 160 P63	3477 UFR 160 P63	160	300
3470 UFR 200 P63	3478 UFR 200 P63	3477 UFR 200 P63	200	400

### Walkway Castors - Automatic Wheel brake Series STORA

housing made of pressed steel, zinc-chromatised, double ball bearing swivel head,  
wheel axle with nut, wheel centre made of polyurethane.

Tread: polyurethane, 4 tracks, self cleaning between tracks, with threadguards,  
precision ball bearing, distances between tracks: approx. 4.5 mm, track

width: approx. 4.0 mm, load capacity 80 / 40 kgs/castor on walkways, bolt hole 12.3 mm



Art. No.	size (mm)
2875 QMP 125 P30	125



BETTER MOBILITY. BETTER LIFE.

## Castor Wheels



BETTER MOBILITY. BETTER LIFE.

### Medical - Bed Castor Wheels Series SMART

Swivel castor with central, total lock and central directional lock, stem with cam hole for profile bars. Wheel centre made of polyamide  
Tread: polyurethane, precision ball bearing



Art. No.	swivel type	size (mm)	load capacity (kg) static
1044 UAP 100 R26-28S45		100	200
1044 UAP 125 R26-28S45		125	200

### Medical - Bed Castor Wheels Series SMART

Swivel castor with central total lock, stem with cam hole for profile bars. Wheel centre made of polyamide  
Tread: polyurethane, precision ball bearing



Art. No.	swivel type	size (mm)	load capacity (kg) static
1046 UAP 100 R26-28S45		100	200
1046 UAP 125 R26-28S45		125	200

### Medical - Bed Castor Wheels Series INTEGRAL

Swivel castor with central, total lock and central directional lock, frame made of pressed steel, precision ball bearing in swivel head and wheel, housing cover made of synthetic plastics, stem with cam hole for profile bars. Wheel centre made of polyamide  
Tread: polyurethane, with threadguards, precision ball bearing, sealed



Art. No.	swivel type	size (mm)	load capacity (kg) static
2044 UAX 200 R26-28S45		200	400

### Medical - Bed Castor Wheels Series INTEGRAL

Swivel castor with central, total lock, frame made of pressed steel, precision ball bearing in swivel head and wheel, housing cover made of synthetic plastics, stem with cam hole for profile bars. Wheel centre made of polyamide  
Tread: polyurethane, with threadguards, precision ball bearing, sealed



Art. No.	swivel type	size (mm)	load capacity (kg) static
2046 UAX 200 R26-28S45		200	400



## Castor Wheels



### Heavy Duty Castor Wheels Series ZETA

housing made of very heavy pressed steel, reinforced, yellow zinc-plated, wheel centre made of aluminium  
Tread: black elastic-tyre, vulcanized, precision ball bearing



BETTER MOBILITY. BETTER LIFE.

**Swivel Type**



sealed swivel double ball bearing, reinforced and heat treated ball covers, riveted king pin, wheel axle with nut

**Fixed Type**



fork made of heavy pressed steel, reinforced, yellow zinc plated, wheel axle with nut

**Brake Type**



with wheel brake, double ball bearing swivel head, wheel axle with nut

Art. No. swivel type	Art. No. fixed type	Art. No. brake type	size (mm)	load capacity (kg)
4680 IEP 125 P63	4688 IEP 125 P63	4687 IEP 125 P63	125	300
4680 IEP 160 P63	4688 IEP 160 P63	4687 IEP 160 P63	160	350
4680 IEP 200 P63	4688 IEP 200 P63	4687 IEP 200 P63	200	400
4680 IEP 250 P63	4688 IEP 250 P63	4687 IEP 250 P63	250	450

### Heavy Duty Castor Wheels Series KAPPA

housing made of very heavy pressed steel, reinforced, yellow zinc-plated, wheel centre made of aluminium  
Tread: black elastic-tyre, vulcanized, precision ball bearing

**Swivel Type**



sealed swivel double ball bearing, reinforced and heat treated ball covers, riveted king pin, wheel axle with nut

**Fixed Type**



fork made of heavy pressed steel, reinforced, yellow zinc plated, wheel axle with nut

**Brake Type**



with total lock, head end of castor, sealed single swivel double ball bearing, threaded king pin and locking nut secured, wheel axle with nut

Art. No. swivel type	Art. No. fixed type	Art. No. brake type	size (mm)	load capacity (kg)
9680 ITP 100 P63	9680 ITP 100 P63	-	100	400
9680 ITP 125 P63	9688 ITP 125 P63	9682 ITP 125 P63	125	500
9680 ITP 160 P63	9688 ITP 160 P63	9682 ITP 160 P63	160	800
9680 ITP 200 P63	9688 ITP 200 P63	9682 ITP 200 P63	200	800
9680 ITP 250 P63	9688 ITP 250 P63	9682 ITP 250 P63	250	1000



## E-DRIVE FLEX - electrical driving unit

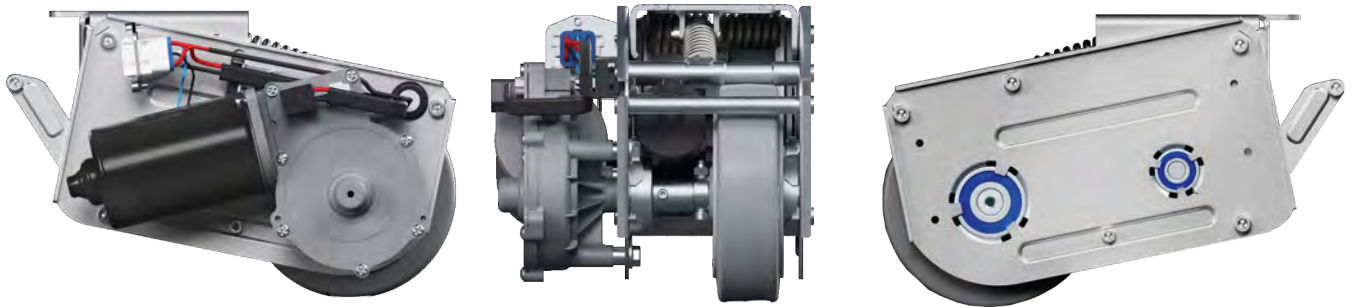

### Increased productivity

E-Drive flex helps to make design operational procedures more efficient and, as a result, to realise cost savings.

### High flexibility

Thanks to the lifting motor, E-Drive flex can be switched on as required and has no ground contact when in standby position. The practical system also makes it easy to integrate this into existing transport devices.

### Improved ergonomics

The ergonomic system helps to prevent ailments to the neck, back, shoulders and hands among users - especially in times of high demographic change. Your investment in E-Drive flex will quickly bear fruit through fewer illness-related absences.



#### Application example of E-Drive flex

Foldable transport trolley with all E-Drive flex components. The battery displayed here is the lithium-ion battery set.

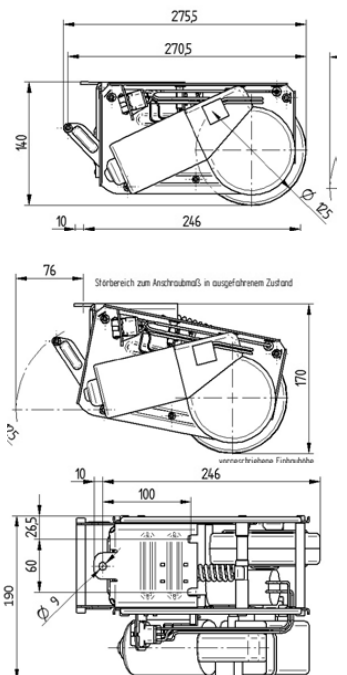

**BETTER MOBILITY. BETTER LIFE.**